

# FORD TRUCKS USER MANUAL



[f/FordTrucksInternational](#) [v//FordTrucksInternational](#) [in//FordTrucksInternational](#) [@/fordtrucksinternational](#)  
[www.fordtrucks.com.tr](http://www.fordtrucks.com.tr)



Sharing the load

The illustrations, technical information, data and descriptions contained in this publication, were correct at the time of going to print. We reserve the right to make any changes necessary in line with continuous development and improvement/

This publication may not be duplicated, reprinted, stored in a data processing system or transmitted by electronic, mechanical, photographic or other means, or recorded, translated, edited, abridged or expanded without prior written consent of Ford Otomotiv San A.S. The same also applies for parts of this manual and their use in other applications.

Although due care has been taken to make it as complete and accurate as possible, it can still be subject to alterations. This publication describes options and trim levels available throughout the Ford model range in every country, and therefore some of the items covered may not apply to your vehicle.

Important: Ford genuine parts and accessories have been specifically designed for Ford vehicles. They are dedicated for your Ford vehicle.

We would like to point out that other parts and accessories than mentioned above have not been examined and approved by Ford unless explicitly stated by Ford. In spite of continuous market product monitoring, we cannot certify the suitability of such products. Ford is not liable for any damage caused by use of such products.

© September 2021 Copyright Issued by Ford Otomotiv San. A.S., Ford Customer Service Division

# Table of Contents

<b>INTRODUCTION</b>	<b>1</b>	Circuit Breakers .....	78	Towing the Vehicle .....	188
Accessories and Parts .....	2	A/C and Heater.....	80	Electrical Systems.....	190
Dashboard.....	4	Driving .....	91	Changing Bulbs .....	199
<b>SAFETY</b>	<b>6</b>	Braking.....	95	Suspension Systems.....	204
Seat Belts .....	7	Shifting .....	104	Locations of the Tools in the Vehicle .....	206
Park Brake Control .....	9	Power take off.....	114	Questions and Remedies .....	207
Tires and Wheels .....	10	While driving.....	116	<b>TECHNICAL SPECIFICATIONS</b>	<b>210</b>
General Safety Warnings .....	12	ECAS (Electronically Controlled Air Suspension) .....	119	Labels.....	211
<b>CONTROLS AND INDICATORS</b>	<b>15</b>	Air Suspension		Fluid Filling Capacities.....	212
Instrument Panel .....	16	Mechanical Level Adjustment .....	122	Engine Specifications .....	215
Trip Computer.....	27	Tag Axles.....	123	Transmission Specifications .....	217
Control Buttons.....	35	EBS-ESP .....	127	Installation of Upper structure .....	219
Multi-functional Handles .....	38	Differential Lock.....	129	<b>AUXILIARY HEATER</b>	<b>220</b>
Tachograph.....	41	Lane Departure Warning System .....	132	Airtronic/Airtronic M .....	220
Tachograph Simulator Unit .....	47	Emergency braking system.....	135	Hydronic M-II .....	272
<b>OPERATION</b>	<b>48</b>	Useful Information.....	140	<b>ANNEXES</b>	<b>323</b>
Opening and closing of the vehicle .....	49	<b>MAINTENANCE AND SERVICE</b>	<b>144</b>	Declaration of Confirmty .....	323
Cab Ventilation.....	54	Attaching and Detaching a Trailer .....	145		
Seats and Beds .....	55	Fuel Quality and Refueling .....	155		
In-cab storage compartments .....	65	Cleaning of Exhaust Filter .....	157		
Steering .....	68	Urea System .....	160		
Mirrors .....	69	Tires and Rims .....	163		
Lighting.....	71	Driver Cab .....	174		
Window Washing and Heating Systems .....	76	Engine .....	176		
		Steering .....	187		

# About This Manual

## ABOUT THIS MANUAL

Thank you for choosing Ford. We recommend that you take some time to get to know your vehicle by reading this manual. The more that you know about it, the greater the safety and pleasure you will get from driving it.

Also some features may be explained although they are not introduced because of the time periods between the dates of issue.

Regular servicing of your vehicle helps maintain both its roadworthiness and its resale value.

More than 100 Ford Authorized Dealerships around the world will offer you help with their professional service experience.

Authorized Dealerships provide you the best expert service with their specifically trained personnel. Moreover, they are supported with a wide range of tools and equipment specially developed for applying service on Ford vehicles.

Note: Remember to pass on the Owner's manual when reselling the vehicle. It is an integral part of the vehicle.

All technical information and data included in this manual are valid in the issue date of this manual. However, we reserve the right to make changes without prior information due to our continuous product development policy as  
FORD OTOSAN.

Some features described in the user manual may not be present in your vehicle depending on the vehicle model.

**Regards,  
FORD OTOMOTİV SANAYİ A. Ş.**

**For Diesel Vehicles  
CAUTION !**

Use only EN590 compliant, high quality fuel (Eurodiesel) with low ratio of sulphur. Fuel-related faults that may occur when EN590 compliant, high quality fuel (Eurodiesel) with low ratio of sulphur is not used shall be considered out of warranty cover.

**FORD OTOSAN**



# 1 INTRODUCTION

## Accessories and Parts

### PARTS AND ACCESSORIES

Your Ford has been built to the highest standards using high quality Ford Original Parts. You may enjoy driving your vehicle for years.

We advise you to use Ford Original Parts only when an unexpected situation occurs and a part should be replaced.

The use of Ford Original Parts ensures that your vehicle is repaired to its pre-accident condition and maintains its maximum residual value.

Ford Original Parts complies with the strictest safety conditions and highest safety standards of Ford. Thus, they offer the best total repair cost including the costs of parts and labor.

Now it is much more easier to understand if the part offered to you is a Ford Original Part. Ford Original Parts listed below have a Ford logo on them.

Inspect whether the part has a Ford logo in case of a repair, and make sure that Ford Original Parts listed below have a

Ford logo on them. Inspect whether the part has a Ford logo in case of a repair, and make sure that Ford Original Parts are used.

### Symbols on your vehicle



When you see these symbols, refer to the relevant section of this manual before touching any part or attempting an adjustment of any kind.

### SYMBOLS GLOSSARY

#### Symbols in this manual



#### WARNING

If you do not follow the instructions marked with the warning symbols, you may expose yourself and others to an accident resulting in death or injury.



#### CAUTION

You risk damaging your vehicle, if you do not follow the instructions highlighted by the caution symbol.

## ACCESSORIES, SPARE PARTS AND MODIFICATIONS

Today, there are many non-original parts and accessories are being sold in the market for FORD TRUCKS vehicles. Using these types of non- original FORD TRUCKS parts and accessories (even these parts are authorized by some institutions in your country) may have an adverse effect on the safety of your vehicle. Therefore, non-original FORD TRUCKS parts and accessories and problems likely to result from the usage of these are not considered under warranty and this does not put FORD TRUCKS under any liability.

No modifications should be performed on this vehicle. Any modification on your FORD TRUCKS could effect your vehicle's performance, safety, and durability, and it might also be against legal regulations. Additionally, any damage and performance problems due to the modification of your vehicle are not considered under warranty cover.

**FORD OTOMOTİV SANAYİ A. Ş.**

# 1 INTRODUCTION

## Dashboard

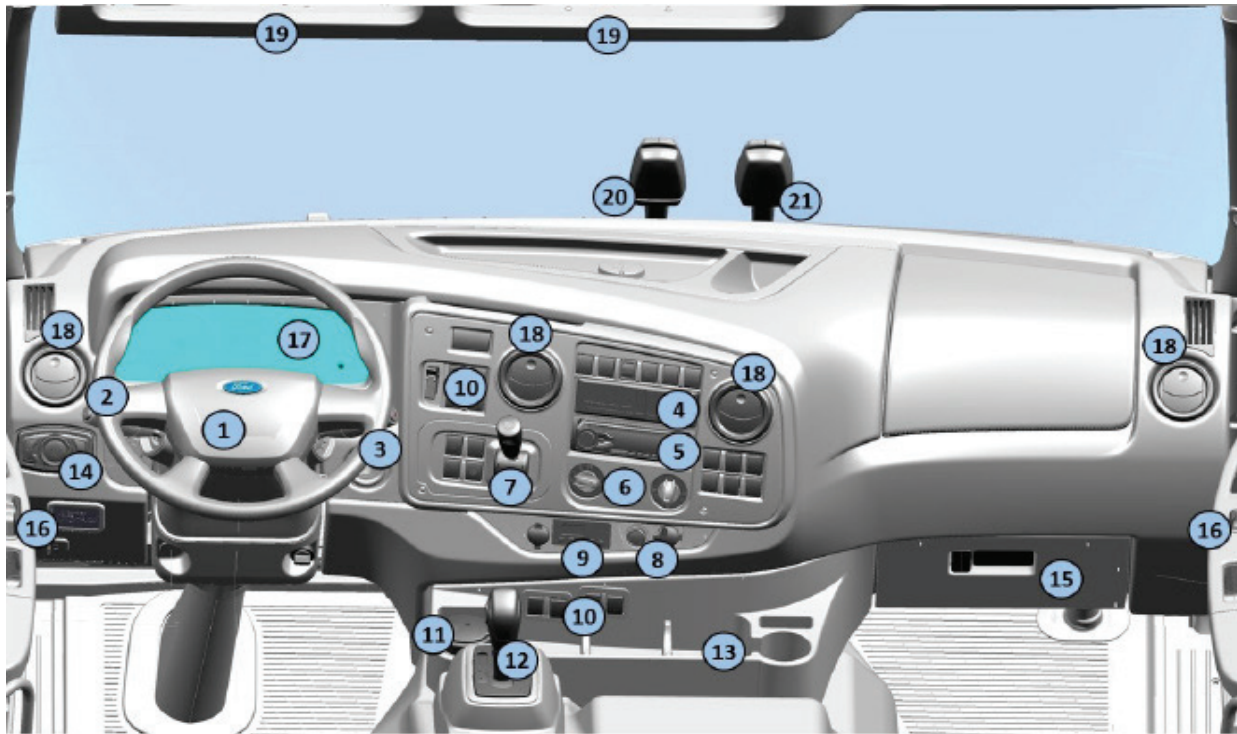



## Dashboard

1	Steering
2	Multi-functional handle (left)
3	Multi-functional handle (right)
4	Tachograph
5	Radio
6	Air Conditioner/Heater switching unit
7	Parking brake
8	Lighter / 12V outlet / 2
9	Auxiliary heater digital control unit
10	Control panel/control buttons
11	Ashtray

12	Gear
13	Centre console/Bottle holder
14	Headlamp switch
15	Glove box
16	Window regulator control buttons
17	Digital indicator
18	Ventilation and air conditioner/ heater air vents
19	Storage compartments
20	Camera
21	Rain sensor

# SAFETY

2



Seat belts provided with your vehicle are the most important on-board safety equipment.

Seat belts minimize the risk of injury by reducing the movement of the occupants in the direction of impact and their contact with the interior in case of a crash.

Always fasten your seat belts while driving. Seat belt shall not loose or bent or shall not be blocked by another occupant or load.



### WARNING

Seat belt cannot provide its protection function if you do not fasten it correctly or ensure that the belt lock is engaged properly. Otherwise, you may get seriously or fatally injured in case of an accident. Ensure that all occupants of the vehicle have properly fastened their seat belts to prevent this.



### WARNING

While you are fastening your seat belt, ensure that,

- it does not pass through your belly that it passes through your hip, e.g. your thighs
- it is tight
- it is not twisted any way
- it passes through the middle of your shoulders
- it does not pass through your neck or armpits - it is strained on your hips by pulling it upwards from the chest .

Do not fasten the belt with heavy items and avoid wearing thick clothes. Do not fasten the seat belt over fragile objects in or on your clothes such as glasses, keys, pens etc. Use a seat belt for only one person. Never travel with your children on your lap and do not fasten the seat belt over them.



### WARNING

Seat belts provide safety inside the vehicle when the occupants are seated in vertical position while the backrests of the seat are in vertical position.

Avoid seating position that prevents correct operation of the seat belts. Do not drive while the backrest is leaned backwards excessively.



### WARNING

#### SEAT BELT REMINDER

The system only provides protection when you wear your seat belt correctly.

A warning light lights up and a beep sounds in the following situations:

- Driver seat occupied or front seat occupied.

- The front seat belts are not fastened.
- Your vehicle exceeds a relatively low speed.

The warning light also comes on when the front seat belt is removed while your vehicle is moving.

If you do not fasten your seat belt, the audible and visual warnings will stop after about five minutes.

# SAFETY

## 2

### Seat Belts



#### WARNING

Seat belt cannot provide proper functionality when the belt or lock of the seat belt is damaged. To prevent this, check the seat belts for damage or jamming periodically.

Otherwise, seat belt may be torn in case of an accident and cause serious or fatal injuries.

#### Fastening the seat belt



Pull the seat belt continuously from the reel. Seat belt may be locked when it is pulled too fast or when the vehicle is on a slope. In this case, relieve the seat belt and allow it to retract a little, then try again. Hear the locking click when you are inserting the latch of the seat belt to the buckle. Otherwise, seat belt is not locked.



Press the red button on the buckle to release the seat belt. Then, release the belt slowly to allow that it is wound on the reel fully.

Seat belt shall pass through the middle of your shoulder. And, the waist part shall be seated firmly on your hips, not on your stomach.

## Park Brake Control

Park brake is placed on the front console. Always apply the park brake after parking the vehicle. Check the tires if the vehicle is parked on a slope.

### Park position

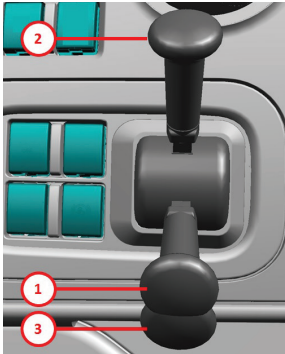

Bring the park brake lever to ① position. Red **(P)** illuminates on the indicator when the park brake is applied.  
· TEST POSITION:(TRACTOR VEHICLES)  
After taking lever to position 1, check whether the vehicle with semi-trailer moves by pressing on the lever and pulling the lever down (position 3).

Then, bring the lever to park position (position 1) again.  
· Then, get off the vehicle and apply the trailer park brake.

### Drive position:

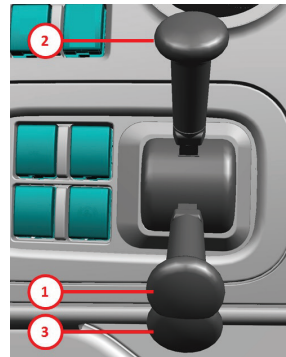

Bring the park brake lever to ② position.



### WARNING

Do not apply the park brake while the brake drums or disks are very hot, wait for them to cool.



### WARNING

Park brake is spring type. If there is not enough pressure in the air tanks, park brake will not be released from the control lever. There shall be enough air pressure on the tanks to release the brake. If there is not enough pressure, the brake can be release by turning the setting mechanism of the adjustment bolt located on the park brake bellows. Before releasing the park brake spring, ensure the safety of your vehicle by chocking the wheels. Do not drive the vehicle if any park brake circuits are not working.

Bellows may be frozen if the brakes cannot be released while the lever is released on winter. Spring is shrunk by rotating the bellows installation bolt in the tightening direction. To ensure that the emergency spring is fully installed, installation bolt shall be tightened until it does not turn anymore.



# SAFETY

## 2

### Tires and Wheels

One of the most important safety elements on your vehicle is the tires. Check the tire pressure and condition periodically. Do not drive your vehicle with worn tires.

-When

the tire pressure is very low, tires may get extremely heated, worn and these may cause excessive fuel consumption.

-When the tire pressure is very high, this may cause longer braking distance, worse handling and excessive wear on tires.

-If the pressure loss happens continuously, this may be caused by external damages, cracks, foreign material in the tires and faulty tire valves leaking air.



#### WARNING

Please, observe the prescribed tire pressure for your vehicle.

Very low tire pressure may cause blow-out of the tire at high speeds and loads. You can cause an accident and thus injuries to others due to this.

#### Tire profiles

A minimum profile depth is prescribed for tires by law. Observe the legislation for the relevant country.

For safety reasons, change your tires before reaching the legally advised minimum profile depth.



#### WARNING

An excessively low tire profile may cause loss of handling at high speeds in case of rain or snow mud conditions. You may lose your handling and cause an accident in these conditions.

#### The Condition of the Tires

Check the following conditions regularly every 2 weeks and before a long haul to inspect the condition of the tires:

-External damage

-Cracks and bulges on the tires,

-Foreign material in the tire profile,

- Irregular wear of the profile.



#### WARNING

Do not forget that the external damages, bulges and cracks on the tires may cause blowout of the tire. You may cause an accident in these conditions.

### The Aging of the Tires

- Aging of the tires reduces the operation and traffic safety of the tires. Even unused tires are aged.
- Always replace your tires if they are aged more than 6 years.

### Tire Damages

- Tire damages are usually caused by the following reasons:
- Aging of the tire
  - Foreign material
  - Usage conditions of the vehicle
  - Weather conditions
  - Oil, fuel, grease etc. Contact with materials - Dragging on the sidewalks
  - Low or high tire pressure



### WARNING

When your vehicle passes over the sides of the sidewalks or objects with sharp edges, this may cause damages that cannot be seen externally.

These damages can only be noticed in the future and cause a flat tire.

Do not park your vehicle with some part of the tire on the sidewalk.

# SAFETY

## 2

### General Safety Warnings



#### WARNING

Failure to observe following conditions may cause accidents which may result in serious injuries.

- Using a mobile phone while driving may distract you.
- Do not adjust the seat and steering wheel while driving.
- Occupants travelling on any other place than seats (e.g. on the bed) may cause serious injuries while braking.
- Do not put any objects on the beds inside the cab; this may cause serious injuries while braking.



#### WARNING

Make sure that the heater is off before refuelling of the vehicles with additional fuel tank for additional cab heater.



#### WARNING

Items that you may place on the toolbox compartment shall not exceed 8 kg. Also, precautions shall be taken against the risk of items moving and damaging the toolbox compartment when the vehicle is moving.



#### WARNING

Do not carry or store material harmful to the health inside the driver cab.

Examples of these materials are:

- Fuel
- Acid
- Lubricants and grease - Cleaning agents

#### Vehicle Tracking Safety System

Fleet tracking systems are also used for finding the location of the vehicle in case of car theft.

However if the vehicle tracking module is removed, the location of the vehicle can not be found.

Vehicle Tracking Safety System eliminates this problem which is the weak point of the fleet tracking systems, since the module can not be removed and prevents the stolen vehicle from being driving away.

In vehicles with optional vehicle tracking safety system, starting may be last up to 35 seconds when the disconnecting switch shut off because of the safety package.

After the ignition is on, wait for the red immobilizer light to dim out  before starting.

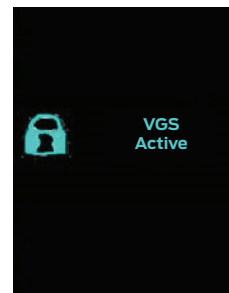

Vehicle tracking safety system warning indicator

If the instrument panel and FMS cannot communicate while the ignition is on, the vehicle cannot be started.

This prevents the starting of the vehicle without GPS tracking.

Vehicle cannot be started and indicates a warning in this case. This prevents the starting of the vehicle without GPS tracking. Vehicle can not be started and indicates a warning in this case.



## General Safety Warnings

### Cleaning of Exhaust Filter

The exhaust filter found in Euro 6 vehicles retains the smut coming from the exhaust gas and decreases the emission values. With the exhaust filter cleaning operation which can be performed automatically or manually, the smut retained in the filter is burned with regular intervals so that the filter is emptied before filling up and being clogged. In this operation, the exhaust gas is heated by the engine and smut is burned. Driver is informed about the exhaust filter cleaning of the vehicle through the messages displayed on the indicator panel and explained in detail in the Exhaust Filter Cleaning section.

### WARNING

Since the exhaust gas shall heat up during the exhaust filter cleaning; ensure that the vehicle is not in the same place with flammable, inflammable and explosive materials or in enclosed space

### WARNING

Ensure that vehicle exhaust cleaning is not performed in locations like hazardous material loading and unloading places or fuelling stations. When necessary, activate

the exhaust filter cleaning prevention using exhaust filter cleaning prevention button.

### CAUTION

Using exhaust filter cleaning prevention for prolonged time may cause the exhaust filter to be clogged and rendered unusable. Please observe the warnings provided in the indicator panel and do not use manual filter cleaning prevention unless necessary.

### CAUTION

When there are personnel on the step at the rear of garbage trucks, vehicle speed is limited to 30 km/h and vehicle can not reverse.

### ERA-Glonass



### The “ERA” mode:

Backlight of buttons “SOS”,”Service” – white light

### The “Emergency Call” Mode:

Backlight of button “SOS” – red light,  
Backlight of button “Service” – white light.

### Backlight of the LED:

-Switching on – red light 5 sec, then green flashing;  
-The “ERA” mode – green light;  
-Data transfer in the “Emergency Call” mode – green light; -Malfunction – red light.

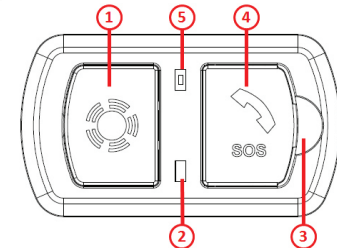

- 1- Service Button
- 2-Microphone
- 3-Protective cover
- 4-SOS Button
- 5-Led

# SAFETY

## 2

### General Safety Warnings

#### Process steps of damper learning

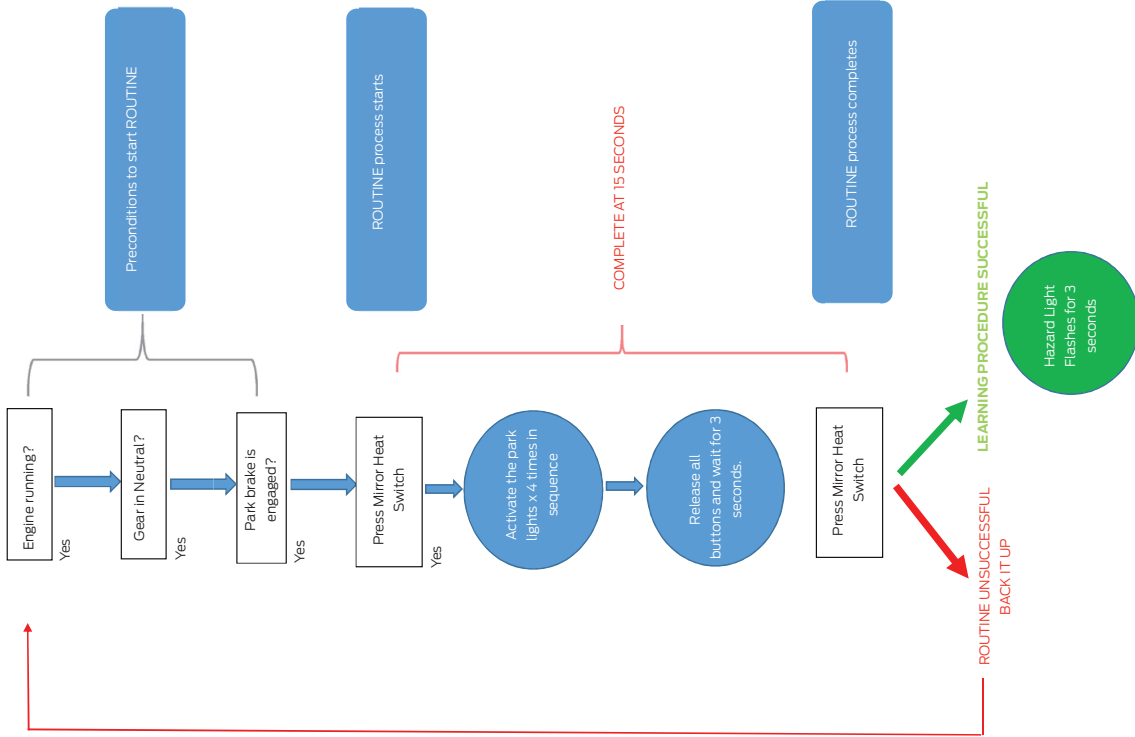

# CONTROLS AND INDICATORS

# CONTROLS AND INDICATORS

## Instrument Panel

3

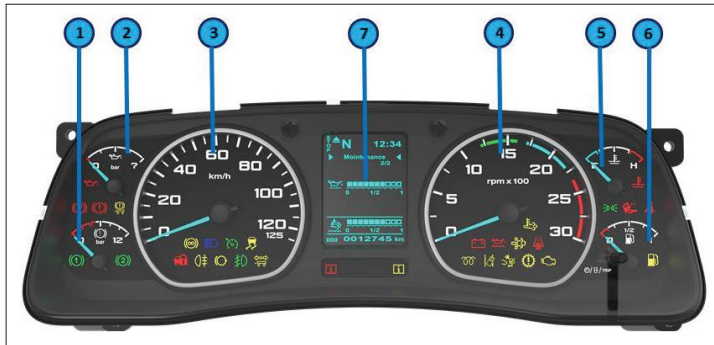









1	Air pressure indicator
2	Engine oil pressure indicator
3	Speedometer
4	Tachometer
5	Engine coolant temperature gauge
6	Fuel gauge
7	Trip computer

# CONTROLS AND INDICATORS

## Instrument Panel









3

FUNCTION	SYMBOL	COLOR	BUZZER	BUZZER
Left Signal Lamp		Green	Multi-functional handle (left)	yes
Right Signal Lamp		Green		
Low brake air pressure		Red	Instrument	yes
EBS		Red / Amber	Automatic	n/a
ABS		Amber	Automatic	n/a
High Beam		Blue	Multi-functional handle (left)	n/a
Alternator / Charging system		Red	Automatic	n/a
Park Brake Sign		Red	Park brake control	n/a
Cab Lock Sign		Red	Cab lifting mechanism	yes

# CONTROLS AND INDICATORS

## Instrument Panel









3

FUNCTION	SYMBOL	COLOR	BUZZER	BUZZER
Oil Pressure Warning		Red	Automatic	yes
Cold Starting Aid		Amber	Automatic	n/a
Height Engine Water Temperature		Red	Automatic	yes
Trailer ABS/EBS		Amber	Automatic	n/a
Trailer right/left turn signal warning		Green	Multi-functional handle (left)	n/a
Engine Warning Lamp		Amber	Automatic	n/a
Cruise Control		Green	Multi-functional handle (right)	n/a
Front Fog Lamp		Green	Headlamp switch	n/a
Seat Belt Warning		Red	Automatic	yes

# CONTROLS AND INDICATORS

## Instrument Panel











3

FUNCTION	SYMBOL	COLOR	BUZZER	BUZZER
Rear Fog Lamp		Amber	Headlamp switch	n/a
Fuel Level warning		Amber	Automatic	n/a
Air Pressure 1		Green	Air pressure control button on the indicator	n/a
Air Pressure 2		Green		
Seat belt warning		Red	Automatic	yes
ESP		Amber	control button on the control panel	n/a
Immobilizer		Red	Automatic	n/a
MIL (malfunction indicator lamp)		Amber	Automatic	n/a
Steerable rear axle		Blue	control button on the control panel	n/a

# CONTROLS AND INDICATORS

## Instrument Panel

3











FUNCTION	SYMBOL	COLOR	BUZZER	BUZZER
Retarder		Amber	Automatic	n/a
Oil level warning		Red	Automatic	n/a
Engine brake		Amber	Multi-functional handle (right)	n/a
Information warning		Amber	Automatic	n/a
Lane departure warning system		Amber	Control button on the control panel	yes
Emergency braking system		Amber	Control button on the control panel	yes
Icing warning		Red	Automatic	n/a
Park lamp indicator warning		Green	Headlamp switch	n/a
Exhaust Filter Cleaning		Green	Automatic	n/a
High Exhaust Temperature		Amber	Automatic	n/a
ESP OFF		Amber	Control button on the control panel	n/a



# CONTROLS AND INDICATORS

## Instrument Panel







### Screen warning and error warnings...









SYMBOL	WARNING	WARNING DESCRIPTION
	Drive at constant speed for DPF regeneration.	Exhaust smut filter saturation is above the expected level. This might be caused by the style of driving or the driving time. For the vehicle to be able to conduct automatic filter cleaning, it is advised that you drive the vehicle with a fixed speed above 30kph when you see the green exhaust filter cleaning symbol. If the road conditions are not suitable, it is recommended to perform manual exhaust filter cleaning.
	Perform exhaust cleaning when parked for exhaust system efficiency (with the button).	Exhaust smut filter is filled to the extent that the vehicle cannot perform automatic cleaning. In this case; park the vehicle to a safe location and make sure that the vehicle is not in contact with any flammable material, and then perform manual cleaning using the manual cleaning button. You can find manual cleaning conditions in the manual exhaust filter cleaning section.
	Exhaust filter is too full.	Exhaust filter is too full. Press the button for exhaust cleaning when parked.
	Reset manual inhibition when possible.	Exhaust filter started to fill up excessively while the manual exhaust filter cleaning prevention is active. It is recommended that you lift the exhaust filter cleaning prevention before the filter is overloaded or allow manual filter cleaning. You can remove the filter cleaning prevention by keeping the filter cleaning prevention button for 3 seconds or by restarting the engine after turning off the ignition.
	DPF regeneration is active. Remaining: X min.	Manual exhaust filter cleaning is active During exhaust filter cleaning, the exhaust gas temperature is increased to burn the soot inside the exhaust filter. Time remaining to the end of operation is shown in minutes.
	Regeneration can not be activated. Conditions are not met.	Conditions are not suitable for manual exhaust filter cleaning. In this case, you have to ensure that the conditions written in the manual exhaust filter cleaning section are met
	The exhaust filter could not be cleaned while driving.	The exhaust filter could not be cleaned while driving. Clean the exhaust when parked.
	DPF regeneration inhibition is set by driver.	Exhaust filter cleaning prevention is activated by the driver. You can activate the exhaust filter cleaning prevention while loading hazardous materials or while driving the vehicle in an environment with flammable materials like grass, hay, petroleum products etc. Please keep in mind that the exhaust filter will be damaged in long blocking durations.
	The exhaust is cleaned with high temperature gas. Pay attention to the vehicle environment.	This warning is for the purpose of informing the driver. Exhaust gas temperature is high due to driving under heavy load or exhaust filter cleaning. This warning is activated when the exhaust gas temperature is high and the vehicle speed is low. It is normal to see this warning during exhaust filter cleaning. When the warning is active, please ensure that the vehicle and exhaust fumes are not in the same environment as flammable materials like grass, hay, petroleum products etc. and that the vehicle is not in an enclosed area. Otherwise, fire risk may occur!
	Poor Urea Quality. Use high quality urea for exhaust system efficiency.	Material not conforming to ISO22241-1 standards detected in urea tank. Please discharge the urea tank and add urea conforming to standards. Please remove the error to prevent power cut off .

# CONTROLS AND INDICATORS

## Instrument Panel























3

SYMBOL	WARNING	WARNING DESCRIPTION
	Press clutch pedal select neutral gear to crank	Change the gear lever to neutral and depress the clutch pedal to start the engine.
N/A	AEBS malfunction Service Required	AEBS failure, Service Required
N/A	Front radar sensor blocked See Manual	Front radar sensor is obstructed.
N/A	Front camera malfunction Service Required	Front camera failure, Service Required
N/A	Front camera low visibility See Manual	low camera resolution. Clean the screen.
	Autodrop vehicle overload	Rear axle did not raise. Vehicle loaded.
	Autodrop vehicle speed limit	Rear axle did not raise. Vehicle speed is high
	Autodrop parking brake engaged	Rear axle did not raise. Handbrake applied.
	Trailer brake system problem	AEBS do not support trailer brake system
	Tachograph Break Time	4.5 hours driving time is over Give a break
	Dump lifting active	Lifting Damper Active

SYMBOL	WARNING	WARNING DESCRIPTION
	Lift other axle first	Rear axle did not raise. First raise the front axle.
	Autodrop vehicle speed limit	Rear axle did not lower. Vehicle speed is high
	Autodrop vehicle overload	Front axle did not raise. Vehicle loaded.
	Autodrop vehicle speed limit	Front axle did not raise. Vehicle speed is high
	Autodrop vehicle unladen	Front axle did not lower. Vehicle unloaded
	Autodrop vehicle speed limit	Front axle did not lower. Vehicle speed is high
	Drop other axle first	Front axle did not lower, first lower the rear axle.
	Autodrop vehicle overload	Rear axle lower. Vehicle loaded.
<b>LIM 30 km/h</b>	Speed Limit	Speed limiter will be active after 60s
<b>&gt;40 km/h</b>	Overspeed Warning	40 km/h speed exceeded Slow down
	Battery Service Required	Battery failure, drive to service.

# CONTROLS AND INDICATORS









## Instrument Panel





SYMBOL	WARNING	WARNING DESCRIPTION	SYMBOL	WARNING	WARNING DESCRIPTION
	Autodrop parking brake engaged	Rear axle lower. Handbrake applied.		Check engine oil level	Add oil to engine
	Autodrop vehicle overload	Front axle lowered. Vehicle loaded.	<b>ECAS</b>	ECAS warning active	Air suspension warning active
	Engine shutdown soon press any pedal to cancel	Soon press any pedal to cancel (only manual transmission vehicles)		Engine oil change due	Engine oil renewing time
	VGS active	VGS active		Air filter intake restriction	Air cleaner must be changed as soon as possible. Service Required
	WARNING Clutch over heated	Warning, clutch overheated		Steering low oil pressure	Oil level must be controlled when lit. If there is a leakage, request road assistance. If there is no leakage, drive to nearest workshop without exceeding 50 km/h speed.
	WARNING Clutch protected	Warning, clutch protection active		Fuel filter blocked	Service Required
	Lowliner active	Cab raising active		Low engine coolant level	Add engine cooling water, if warning light does not go out, drive to workshop as soon as possible.
	Door ajar warning	One of the doors is open		Discharge the water in the pre-filter water tank	Discharge the water in pre fuel filter drain, if warning light is still active, drive to workshop as soon as possible.
	Hill holder active	Hill holder active		autodrop failure.. see manuel	Autodrop failure..see manuel
	Apply brake pedal test	Brake pedal test shall be performed		Critical emissions failure	Critical emission error. Perform Exhaust Filter Cleaning.
	Urea dosing malfunction	Error detected in urea dosing system. Please drive to service to prevent power cut off.		Fill Up urea	There is not enough level of urea in the urea tank. Please add urea that conforms to the standards in order to prevent power cut off.
				Urea level low	Urea level low in urea tank. Please add urea that conforms to the standards in order to prevent power cut off.

# CONTROLS AND INDICATORS

## Instrument Panel

3

SYMBOL	WARNING	WARNING DESCRIPTION
	Clutch overheated under heavy strain.	Under heavy pressure, the clutch has overheated.
	Clutch wear is detected.	Clutch wear detected, Service required
	Transmission Temperature	The transmission temperature is too high.
	Transmission self check is active	Transmission automatic control is active.
	Gas Pedal	Release the accelerator pedal.
	Transmission Air Pressure	Transmission air pressure is too low.
	Steerable tag axle	The steerable additional axle was centered
	Steerable tag axle	Steerable additional axle centering was cancelled
	Steerable tag axle	Error code for steerable additional axle: please read the message

SYMBOL	WARNING NAME	WARNING DESCRIPTION
	Mechanical Maintenance Warning	The time for mechanical maintenance is approaching
	Mechanical Maintenance Warning	It's time for mechanical maintenance. Service Required
	Transmission error	Transmission error, visit an authorized dealership.
	Transmission error	Transmission error, visit an authorized dealership.

# CONTROLS AND INDICATORS

## Instrument Panel

3

### Odometer

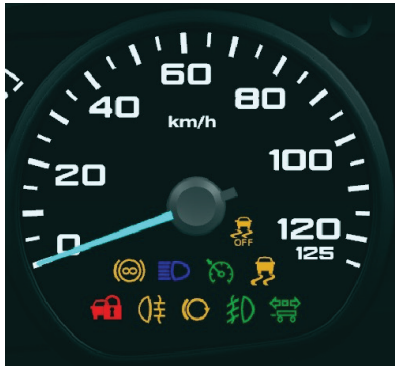

Indicates the road speed (kilometer/hour).

### Tachometer 9 Lt vehicles

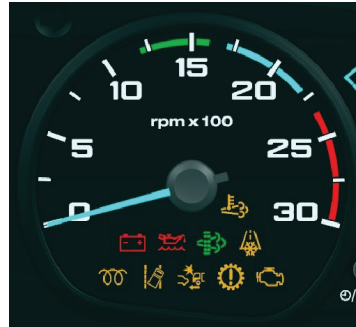

### 12.7Lt vehicles



Indicates the engine rpm. Operate your vehicle so that the indicator dial remains in the green zone as much as possible.

Drive your vehicle considering the engine speed. Keeping engine speed in the green zone provides economy.

Avoid excessive speeds in the red danger zone. Otherwise, your engine may get damaged. Ensure that the speed does not increase up to red danger zone, especially while driving down the hill.

Green zone: economy zone

Blue zone: zone where engine brake is activated

Red zone: Danger zone

Buzzer sounds when you exceed the maximum allowed engine speed. Lower the engine speed when you hear that warning. Engine brake is shut down over of 2400 rpm.

# CONTROLS AND INDICATORS

## Instrument Panel

3

### Engine coolant temperature gauge



Indicates engine coolant temperature. If the dial of the indicator is in the red area, the engine may overheat.



Red warning light is illuminated on the indicator, and the buzzer sounds at 110 °C on vehicles with regulated air compressor. Red warning light is illuminated on the indicator, and the buzzer sounds at 104 °C on vehicles with non-regulated air compressor. Torque reduction values : 110 °C in vehicles with adjustable air compressor, 104 °C vehicles without adjustable air compressor.

Perform the following when the red warning lamp is illuminated:

- Stop the vehicle and operate the engine in idle.
- Apply park brake, check for water leaks
- under the vehicle (do not get under the vehicle.) check from the side.)
- Open the hood and check for the water level in the engine auxiliary water tank. If the water temperature does not drop, stop the engine and tilt the cab. Inspect whether the engine belt is broke.
- Check for water leaks in the thermostat area on the front of the engine.
- Ask the support of a Ford Trucks authorized dealership, if required.

### Fuel gauge



Indicates the fuel level in the tank.

0: empty  
1/2: half full  
1: full

Amber warning lamp indicates low fuel level in the tank. Refill fuel immediately. System will take air if the fuel is lowered.

### Icing Warning

Icing warning lamp will light up if outside temperature is between

0 and 4 degrees. If the outside temperature is below 0 degrees, icing warning lamp will blink with short intervals.



# CONTROLS AND INDICATORS

## Trip Computer

### Air pressure indicator



There are 2 independent air system circuits that supply for the front and rear brake systems. You can read the pressures of these systems from a single air pressure indicator. Indicator shows the pressure value of the line with low pressure automatically.

Indicator shows the pressure value of the line with low pressure automatically.

If the indicator ① indicates the circuit air pressure, ① light is illuminated.

If the indicator ② indicates the circuit air pressure, ② light is illuminated.

Air pressure indicator always shows the air pressure of the circuit with the lowest air pressure. Press the button on the indicator if you would like to view the air pressure of the other circuit. Indicator will display the pressure of the circuit with the lowest air pressure automatically after a specified time.

Normal operating pressure of the system is 10.5 bars.

If any warning is displayed on the screen, the key on the instrument shall lose the function for tank selection as it will be used for conforming these warnings. If you would like to view the 2nd tank, you can do this by moving to another page from the information page.

### Air pressure audible warning

If the air pressure goes below 6.5 bars, low pressure audible warning will be activated. Buzzer is turned off when system pressure reaches the normal operating pressure at both pressure circuits.

Do not drive your vehicle before the audible warning is deactivated!

If you hear the audible warning while driving stop your vehicle immediately. Block the wheels. Place road safety signs and call a Ford Trucks authorized dealer.

### Oil pressure indicator



Indicates engine oil pressure in "bars". Oil pressure varies depending on the oil temperature and engine speed. Operating pressure: 3 bar @ 90 °C, 2500rpm Idle pressure: 1.5 bars @ 90 °C, 550rpm

The warning lamp will be illuminated when the oil pressure is low.

Perform the following when the red warning lamp is illuminated:



- Park the vehicle in a secure place, stop the engine.

Contact a Ford Trucks authorized dealership.

# CONTROLS AND INDICATORS

## Trip Computer

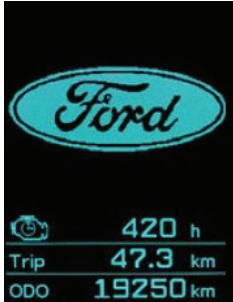
3

<p>SYMBOL</p>			
<p>DESCRIPTION</p>	<p>Prove out</p>	<p>Summary</p>	<p>It is recommended to you to drive to an authorized workshop in this case.</p>



# CONTROLS AND INDICATORS

## Trip Computer

3

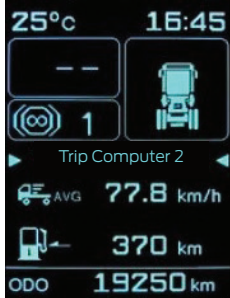
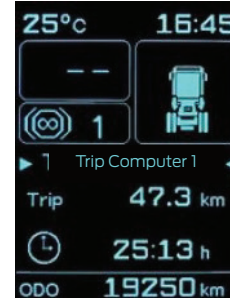
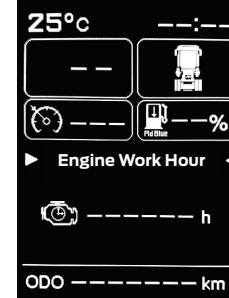
<p><b>SYMBOL</b></p>			
<p><b>DESCRIPTION</b></p>	<p>1-Average speed 2-Distance that may be covered with the remaining fuel</p>	<p>1-Mileage 2-Engine operating hours</p>	<p>Engine total operating hours</p>

# CONTROLS AND INDICATORS

## Trip Computer

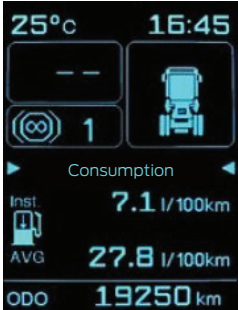
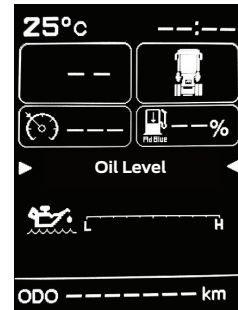
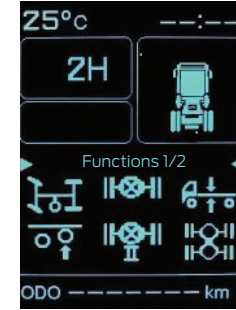

3

<p><b>SYMBOL</b></p>	 <p>The screen displays the temperature as 25°C and the time as 16:45. It shows a fuel consumption icon with the number '1'. Below this, the word 'Consumption' is centered. The 'Inst.' (Instantaneous) consumption is shown as 7.1 l/100km, and the 'AVG' (Average) consumption is 27.8 l/100km. The ODO (Odometer) is 19250 km.</p>
<p><b>DESCRIPTION</b></p>	<p>1-Instantaneous fuel consumption 2-Average fuel consumption.</p>
<p><b>SYMBOL</b></p>	 <p>The screen displays the temperature as 25°C and the time as --:--. It shows an oil level icon. Below this, the word 'Oil Level' is centered. A horizontal bar graph shows the oil level between 'L' and 'H' markers. The ODO is shown as ----- km.</p>
<p><b>DESCRIPTION</b></p>	<p>Oil level</p>
<p><b>SYMBOL</b></p>	 <p>The screen displays the temperature as 25°C and the time as --:--. It shows a '2H' icon. Below this, the word 'Functions 1/2' is centered. The screen displays various function icons. The ODO is shown as ----- km.</p>
<p><b>DESCRIPTION</b></p>	<p>Functions</p>

# CONTROLS AND INDICATORS

## Trip Computer

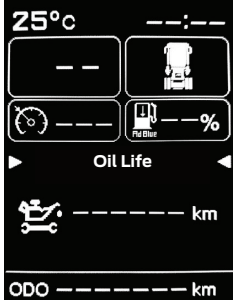
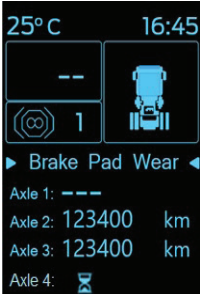
3

<p><b>SYMBOL</b></p>			
<p><b>DESCRIPTION</b></p>	<p>Oil status indicator</p>	<p>The remaining brake pad KM for each wheel is shown.</p> <p> : Data is collected for calculation.          --- : It may be one of the following reasons.          a. Different wear between right and left linings          b. Lining sensor error          c. General Error          d. Remaining lining life is below 6%          e. Fitting lining worn below 35%</p>	<p>Language Selection</p>

# CONTROLS AND INDICATORS

## Trip Computer

3

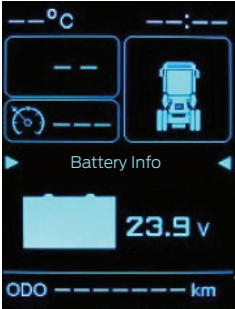
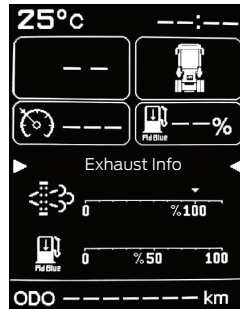
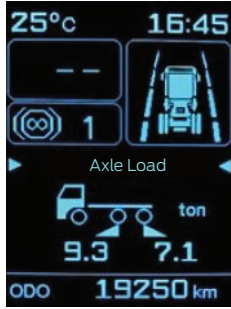
<p><b>SYMBOL</b></p>			
<p><b>DESCRIPTION</b></p>	<p>Battery status</p>	<p>Exhaust info screen</p>	<p>Axle load</p>

# CONTROLS AND INDICATORS

## Trip Computer

3

<p><b>SYMBOL</b></p>			
<p><b>DESCRIPTION</b></p>	<p>Time zone setting</p>	<p>Steerable tag axle</p>	<p>Creep Mode</p>

# CONTROLS AND INDICATORS

## Trip Computer

3

### Caution!

The system cannot detect a direct change when the oil is filled or drained. For the oil level display to be accurate, the engine must be stationary for 10 minutes after the engine has been switched off and on a level surface. Then, with the ignition in position two, engine off, the oil level will be checkable in 1 minute on the center display.

When the vehicle is in motion, the oil level menu will not appear on the center display.

### Oil Level Check

The oil level can be displayed with the engine off, ignition in position two, by selecting the oil level menu on the center display screen. The oil level information will be available within 1 minute after the center display screen is woken up.

In order for the oil level information to be correct, after the engine is switched off, the ignition must be kept in the ignition 0 position for at least 2 minutes on a flat surface. Then, 1 minute after the vehicle is turned to ignition 2 position, oil level information will be displayed on the center display screen.



When calculating the oil level information, wait for the hourglass to finish.



OK: Indicates that the oil level is appropriate and above 20%.



LOW: Indicates that the oil level is not appropriate and is below 20%.

# CONTROLS AND INDICATORS

## Control Buttons

3

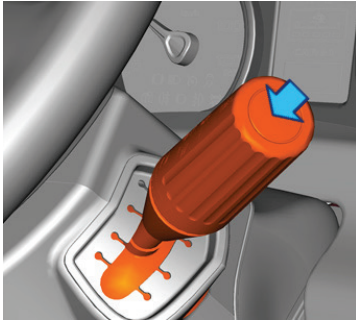

Trip computer shows information and warnings.  
Trip computer may be changed by pressing the menu button on the right multi-functional lever.



You may reset trip computer information, which are allowed to be reset, by pressing the button on the lower right of the instrument panel.

Note: The screen display for the information that will be reset shall be selected via the menu button on the right multi-function arm.



### WARNING

As changing trip computer display settings while driving may adversely affect the driving attention, it may cause serious risk of accident. Settings shall always be performed while the vehicle is parked.

# CONTROLS AND INDICATORS

## Control Buttons

3





# CONTROLS AND INDICATORS

## Control Buttons





































FIGURE	SYMBOL	DESCRIPTION
1		A/C ON/OFF
2		RECIRCULATION
3		MIRROR HEATING
4		WINDSHIELD HEATER
5		ASR CANCEL/ ASR ACTIVE
5		ASR CANCEL/ ASR ACTIVE
6		SEMI-TRAILER BRAKE
7		AUTOMATIC HYBRID BRAKE
8		HILL LAUNCH ASSIST
9		DIESEL PARTICULATE CLEANING ACTIVE
9		DOMELAMPS (OPT)
10		DIESEL PARTICULATE CLEANING DEACTIVATED
11		ROOF ON/OFF
12		ECOROLL SWITCH
13		AUTOMATIC TRANSMISSION MODE SELECTION
13		AUTOMATIC TRANSMISSION MODE SELECTION

FIGURE	SYMBOL	DESCRIPTION
14		CREEP MODE SWITCH
15		REAR AXLE LIFTING
15		FRONT SUSPENSION CONTROL BUTTON
15		TAG AXLE LIFTING II SWITCH
16		DIFFERENTIAL LOCK
17		FRONT AXLE LIFTING
17		INTERMEDIATE SHAFT LOCKING
17		FRONT SUSPENSION LIFTING
17		TRACTION HELP SWITCH
18		REAR STEERABLE AXLE LIFTING SWITCH
18		TRAILER AXLE LIFTING
19		EMERGENCY BRAKING SYSTEM
20		LANE DEPARTURE WARNING SYSTEM
21		WARNING SWITCH HAZARD FLASHER
22		ELECTRICAL CIRCUIT BREAKER (OPT)
23		HANDBRAKE

GLASS SECTION		
FIGURE	SYMBOL	DESCRIPTION
1		INTERIOR LIGHTING
2		POWER TAKE OFF
3		SIREN BUTTON (OPT)
4		POWER TAKE OFF 2

3

Some features may not be available depending on the vehicle version.

# CONTROLS AND INDICATORS

## Multi-functional Handles

3

### Multi-functional handle (left)

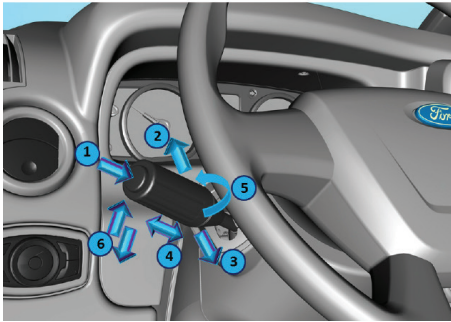

It is placed on the left side of the steering. Switch positions are as follows.

1. Horn
2. Right Direction Indicator
3. Left Direction Indicator



4. Windshield Water Spray 
5. Wipers

5a. Wipers off 

5b. Low speed wiping (long interval)



(This position activates the automatic wiper function on vehicles with a rain sensor.)

- 5c. Normal speed wiping 
- 5d. High speed wiping 

6a- High Beam (Flasher)   
Flasher is operated by pulling the handle briefly and releasing it.

6b- High Beam (Continuous)   
High beam is operated continuously when the handle is released after being pulled at full stroke.

# CONTROLS AND INDICATORS

## Multi-functional Handles

### Multi-functional handle (right)

It has 5 steps in vehicles with retarder.  
It has 2 steps in vehicles without retarder.

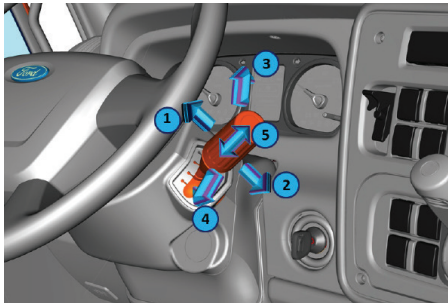

This handle has the following functions:

- Cruise control, increasing the speed, and decreasing the speed
- Engine brake and Retarder

- 1- Activation of the cruise control and increasing the speed
- 2- Decreasing the speed
- 3- Deactivation of the cruise control
- 4- Activation of the engine brake
- 5- Resuming cruise control

### On vehicles without Retarder 2 step engine brake

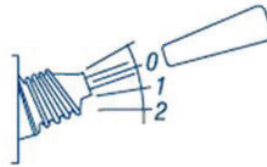

	Engine Brake
1. Range	Low Brake Power
2. Range	High Brake Power

### 1 step engine brake

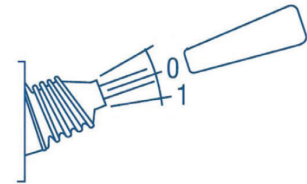

1st stage 100% engine brake while it is in "0" position, blending function is used in the vehicles with ebs.

# CONTROLS AND INDICATORS

## Multi-functional Handles

3

Vehicles with Retarder:

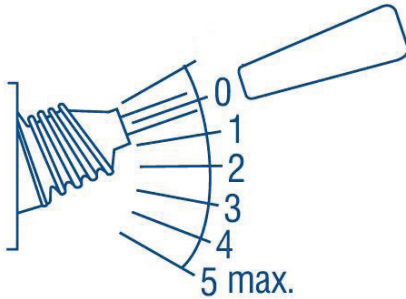

	Engine Brake	Retarder
Bremsomat	Reduced Brake Power	Bremsomat (0%-100%)
Retarder 1	Reduced Brake Power	25% Max. Brake Power
Retarder 2	Reduced Brake Power	50% Max. Brake Power
Retarder 3	High Brake Power	75% Max. Brake Power
Retarder 4	High Brake Power	100% Max. Brake Power

### Activation of the gradual continuous braking operations

Bring the gradual braking lever from 1 to max. position.  
The vehicle is continually decelerated according to the selected position.  
Position 1 = low deceleration  
Max. position = more deceleration.

### Deactivation of the gradual continuous braking operations

- Gradual brake lever:
- OFF position or position 1 = BREMSOMAT function.

# CONTROLS AND INDICATORS

## Tachograph

### Operational elements

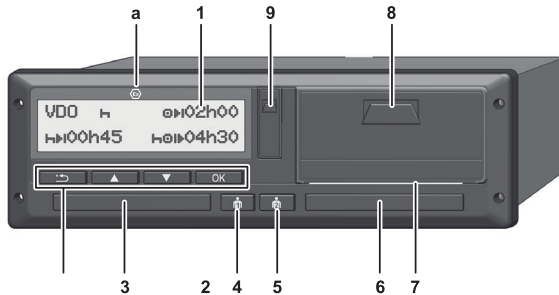

- (1) Display
- (2) Menu buttons
  - ▲ / ▼ Select function / selection
  - OK Confirm function / selection
  - Exit, abort menu
- (3) Card slot 1
- (4) Combination key Driver 1
  - Setting of activities and ejection of the driver card
- (5) Combination key Driver 2
  - Setting of activities and ejection of the driver card
- (6) Card slot 2
- (7) Cutting edge
- (8) Printer drawer
- (9) Download interface
- (a) Symbol for ADR variant

### Standard display(s) during trip

► Press any menu key, change to the desired display.

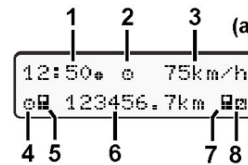

- (1) Time (with "\*" = set local time)
- (2) "Operational mode"
- (3) Speed
- (4) Activity, driver 1
- (5) Card symbol, driver 1
- (6) Toplam kilometre
- (7) Card symbol, driver 2
- (8) Activity, driver 2

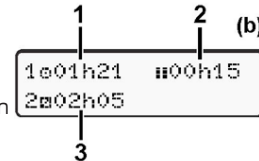

- (1) Driving time "e" Driver 1 since a valid break time.
- (2) Valid break time "u", in accordance with regulation (EU) no. 561/2006.
- (3) Time of driver 2; availability time "m".

The option "VDO Counter" allows another standard display; for details refer to the operating instructions.

# CONTROLS AND INDICATORS

## Tachograph

3

### Calling up menu functions

Possible only when the vehicle is stationary!

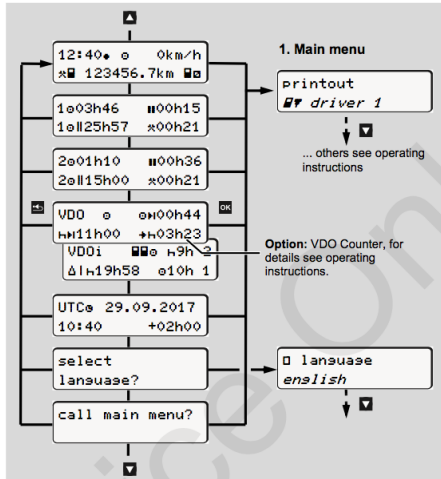

- ▶ Use the buttons **▲/▼** to select the desired display.
- ▶ Use button **OK** to call up the main menu.
- ▶ Use **/** to select the listed **▲/▼** functions step by step.

### Print daily value:

- ▶ [printout **▼** driver 1] ... [24h **▼** day] ... [25.10.2017] ... [printout in UTC yes/no]

### Enter "Out of scope" beginning / end:

- ▶ [entry **A** vehicle] ... [OUT **+** begin] or [**+**OUT end]

### Enter Beginning of ferry / train:

- ▶ [entry **A** vehicle] ... [OUT **+** begin] or [**+**OUT end]

- ▶ Set the current activity.

### Set Local time:

- ▶ [entry **A** vehicle] ... [e local time] ...

- ▶ Set Local time in steps of  $\pm 30$  minutes.

# CONTROLS AND INDICATORS

## Tachograph

### Insert paper roll

- ▶ Press the unlocking surface on the printer panel, the printer drawer opens.
- ▶ Pull the printer drawer out of the DTCO.

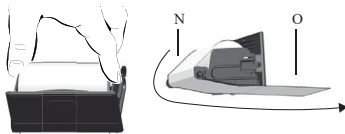

- ▶ Insert new paper roll according to the illustration and guide it via the pulley (1).
- ▶ Make sure that the paper roll does not become jammed in the printer drawer and the start of the paper (1) extends beyond the edge of the printer drawer!
- ▶ Push printer drawer into the printer compartment until it engages.
- ▶ The printer is ready for operation.
- ▶ You can start a printout.

### Messages

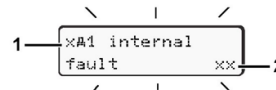

(1) Pictogram and plain text of the message

! = Event, example [!e driving without card]

x = Fault, example [x sensor fault]

! = Driving time warning [! break!]

Operational note, example

(2) Error code

For further messages and measures refer to the operating instructions.

### Acknowledge message:

- ▶ Press key 2 times, the message disappears.

### Times of the driver card(s)

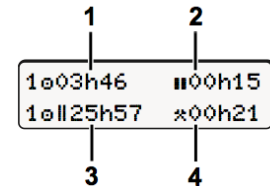

- (1) Driving time "e" since a valid break time.
- (2) Valid break time "00" in accordance with regulation (EU) no. 561/2006.
- (3) Driving time over two weeks "e11".
- (4) Duration of the set activity.

# CONTROLS AND INDICATORS

## Tachograph

3

### Insert driver card / Manual entries

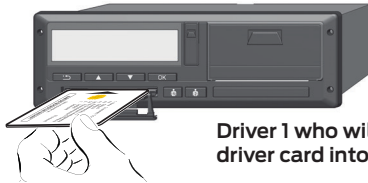

Driver 1 who will drive the vehicle inserts his driver card into slot 1.

- ▶ If necessary, switch on the ignition in case of the ADR variants.
- ▶ Keep the combination key Driver 1 for more than 2 seconds.
- ▶ Set, acknowledge day, hours, minutes. Set, acknowledge the next activity.
- ▶ The card slot is opened.
- ▶ Open the card slot cover.
- ▶ Insert driver card into the card slot.
- ▶ Close card slot and push it in.
- ▶ Follow the menu guidance.

**Always keep the card shafts closed – except for the insertion or removal of your driver card!**

```
welcome
07:35. 05:35UTC
```

```
last withdrawal
15.04.17 16:31.
```

```
1M entry
addition? yes
```

```
continue with example:
A/B/C
```

The set local time "07:35." and the UTC time "05:35UTC" appear (time offset = 2 hours).

The date and time of the most recent card withdrawal will be displayed in local time (symbol ".").

**Please ensure the continuous recording of the activities on your driver card!**

Make manual entries with "Yes".

If you **do not want** to add any activities/rest periods, select "No".

### Example A:

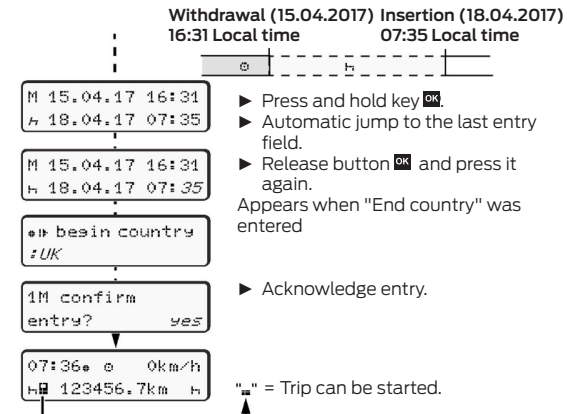



# CONTROLS AND INDICATORS

## Tachograph

Example B:

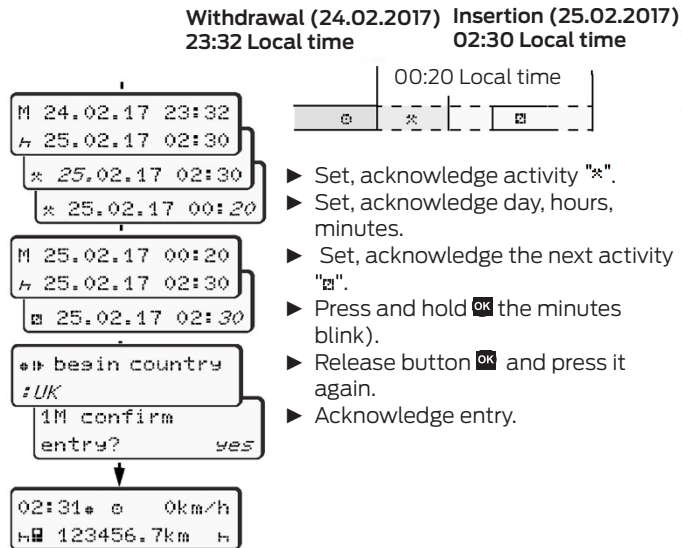

Example C:

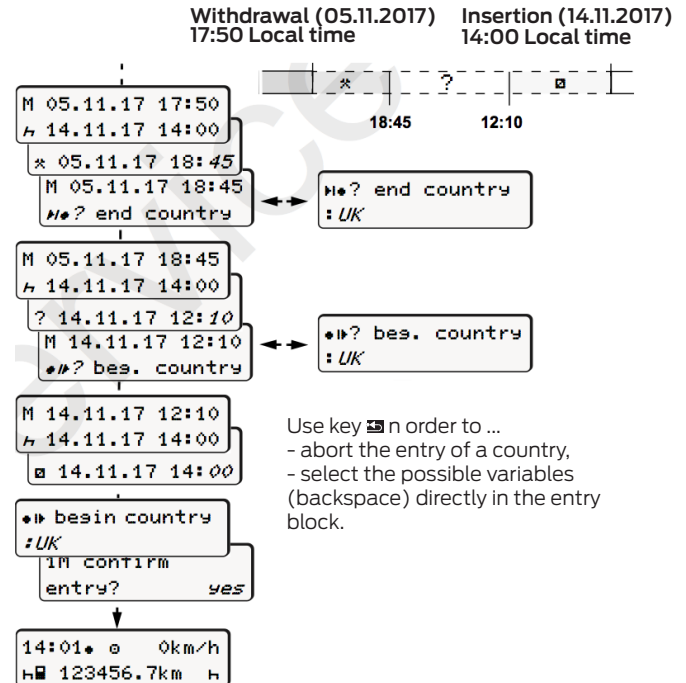

# CONTROLS AND INDICATORS

## Tachograph

3





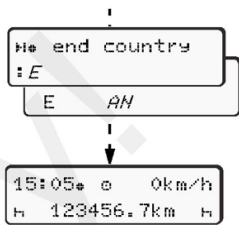





### Withdrawing driver card

- ▶ If necessary, switch on the ignition in case of the ADR variants.
- ▶ Press the corresponding combination button for more than 2 seconds. Follow the menu guidance.



- ▶ Select, acknowledge the country.
- ▶ If present, select region, acknowledge.
- ▶ With button  you can abort the entry of a country if you, for example, want to continue your work shift.
- ▶ The card shaft is opened to withdraw the driver card.
- ▶ Withdraw driver card.
- ▶ Close card slot and push it in.

### Setting activities



-  = Driving time (automatic when driving)
  -  = All other working times (Automatically when the vehicle is stopped, for driver 1)
  -  = Availability: Waiting times, co-driver time, sleeper-cab time during the trip (Automatically when driving or when the vehicle is stopped, for driver 2)
  -  = Break times and rest periods
- ▶ **Driver1:** Press the combination key Driver1 repeatedly for a short time until the desired activity (   ) is shown in the display.
  - ▶ **Driver 2:** Press the combination key Driver 2 repeatedly for a short time until the desired activity (   ) is shown in the display.

At the end of a shift or during a break, always set activity " H

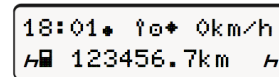
### Automatic setting after ignition on/off (option):



Signalled by flashing of the activity or activities for approx. 5 seconds in the standard display (**a**). Then, the previous display will appear again.

- ▶ As required, change the activity accordingly!  
Symbol "\*" after ignition off means: IMS function (Independent Motion Signal) available.  
Symbol "" after ignition off means: The recording of position and vehicle data is switched on.

# CONTROLS AND INDICATORS

## Tachograph Simulator Unit

3

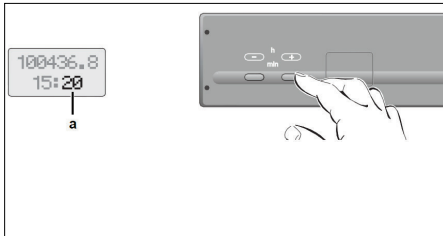
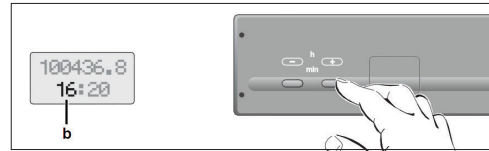
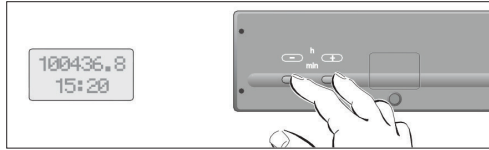
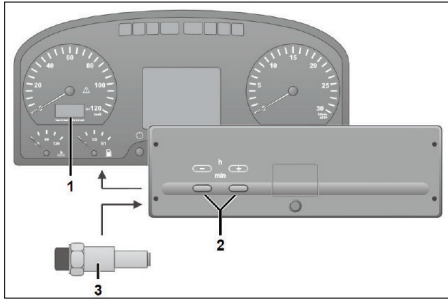

# OPERATION

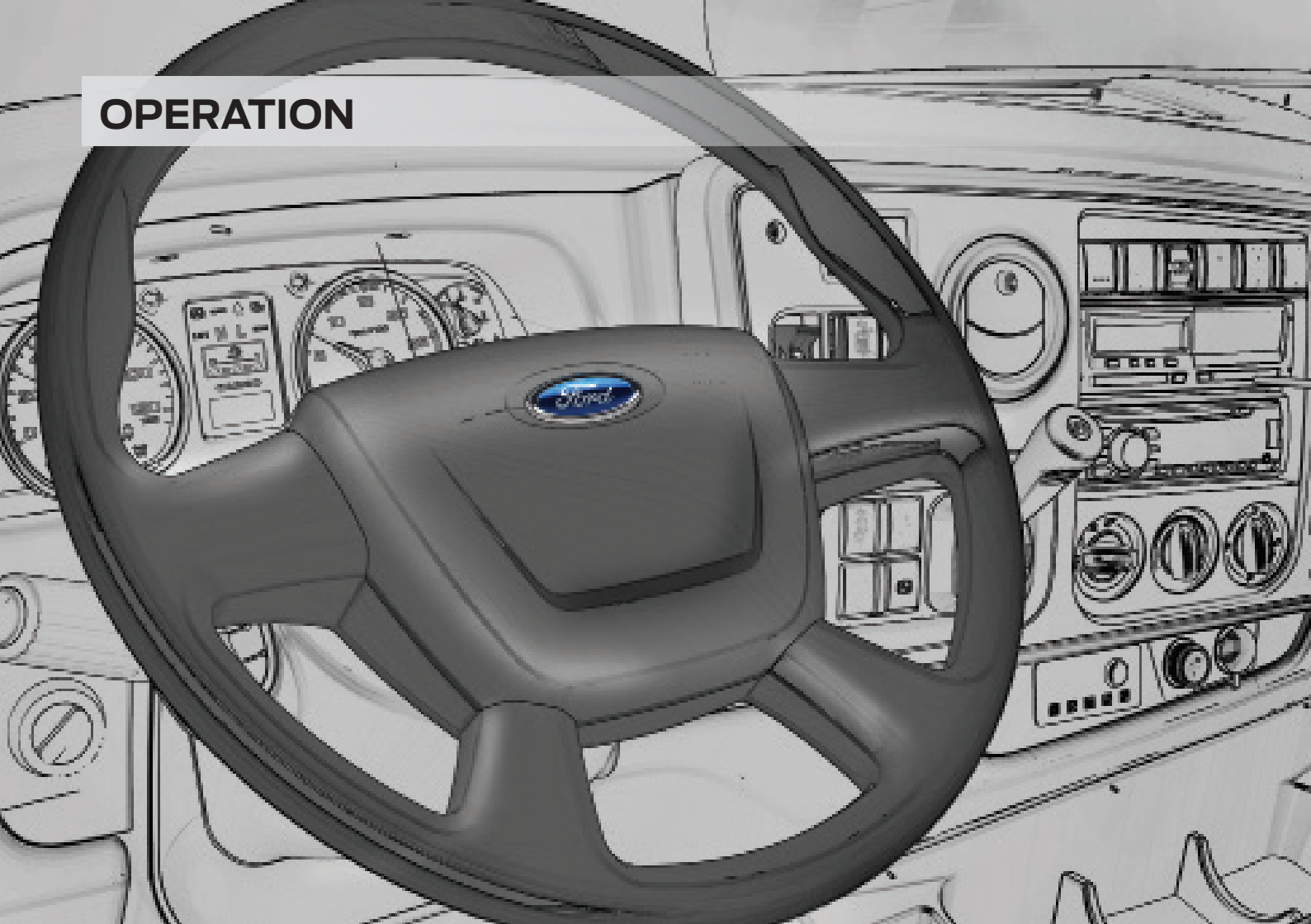

# OPERATION

## Opening and closing of the vehicle

### Keys

2 keys are supplied with the vehicle, one for your use, and one as a spare.

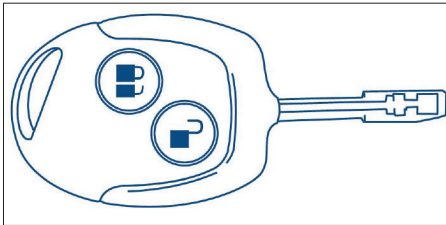

- Door locks
- Ignition
- Front Hood

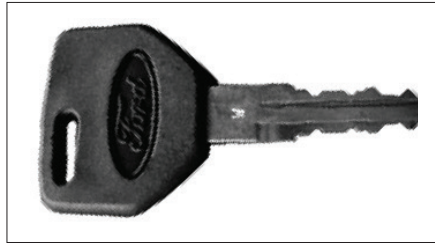
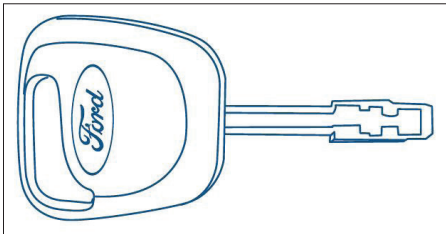

- Fuel tank
- Urea tank (only on Euro 5 and Euro 6 vehicles)



### WARNING

Ignition key has an immobilizer feature against vehicle theft.  
New keys shall be programmed by Ford Otosan authorized dealerships.

### Door Control:

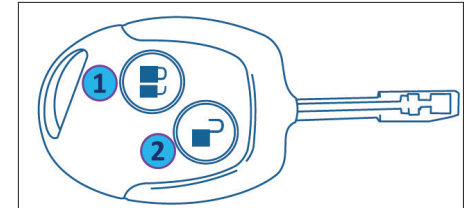

You can lock and unlock doors with the remote control.

1- Locking button

2- Unlocking button

Central locks are opened when the open button of the control is pressed. They are closed when the close button is pressed. If the direction indicators are illuminated for 2 seconds: Doors are locked.

When any of the doors are not closed for any reason (mechanical or electrical), error is detected and both doors are brought to open position.

However, central locking function on manual opening and closing is temporarily disabled until central locks are brought to the same position.

Error is removed when doors are completely closed.

# OPERATION

## Opening and closing of the vehicle

4

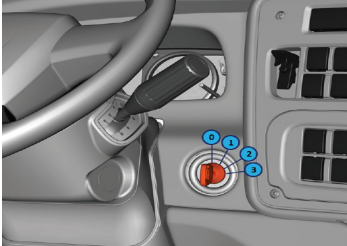

Doors are locked automatically when the speed of your vehicle exceeds 10 km/h.

You may deactivate this feature if required.

To do this, reading lamp button  shall turned on and off 8 times within 10 seconds when the door is open and ignition is at position 2.

Reading lamps shall flash 4 times if the operation is successful. Automatic locking feature when the vehicle speed exceeds 10 km/h is deactivated after this procedure.

Perform the same procedure while doors are closed to reactivate the automatic locking feature.

Note: Wait for 10 seconds if the procedure fails and then try the procedure chain.



### WARNING

New remote controls shall be introduced to the vehicle when a new control is purchased. Please visit a Ford authorized dealer for the introduction of the controls.

Doors are locked again if the central lock is opened with remote control and doors are not opened physically.

Doors are locked automatically when vehicle speed exceeds 10 km/h.



### WARNING

Module switches to protection mode if opening and closing operation is performed successively for 8 times in central locks both manually and via the remote control. System stops manual operation and operations by the control for 7 seconds. It performs the operations received after those 7 seconds later. This condition ends if you wait for 1 minute without any intervention.

### Opening the Window with Remote Control

Doors are unlocked and windows are lowered to the minimum level when opening button on the remote control is pressed for more than 3 seconds. This feature also includes the opening of sunroof with the windows on vehicles with power roof.

### Closing the Window with Remote Control

Doors are locked and windows are closed automatically when closing button on the remote control is pressed for more than 3 seconds.

This feature also includes the closing of sunroof after the doors on vehicles with power roof.

Window closing operation is not performed if the "Quick Window Closing" feature is not set on the windows.

# OPERATION

## Opening and closing of the vehicle

### Outer Handle



Pull the latch towards you to open the door. Door is locked when key is turned clockwise, and unlocked when it is turned counter-clockwise.

### Door Inner Latch

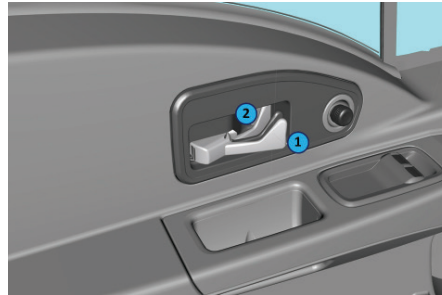

Pull the latch towards you to open the door from the inside. (1)  
Push the latch outwards of the vehicle to lock from inside (2)

### Getting In and Out Of the Vehicle

Use the 3 points principle while getting in and out of the vehicle. Do not hold the steering wheel while getting in the vehicle.

#### Don't:

Do not try to get in the vehicle by holding the steering wheel instead of the handle.

Do not get off the vehicle facing outwards.

Do not get off the vehicle by jumping from the steps.

# OPERATION

## Opening and closing of the vehicle

### Windows



- 1- Driver side window regulator button
- 2- Passenger side window regulator button

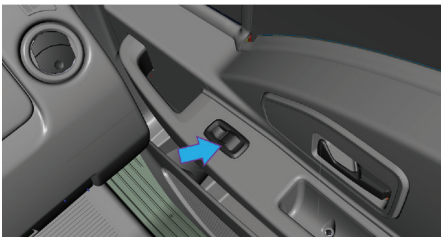

Window moves to opening or closing direction while the opening/closing buttons are pressed. Operation is stopped automatically when the window reaches uppermost or lowermost position. Buttons are active while the ignition is on and for an additional 30 seconds after the ignition is turned off.

#### Quick Window Raising

Window is closed automatically when the window closing button is pressed once for a short time. If jamming is detected while raising the windows, power windows are opened again to a specified level.



#### CAUTION

If the window is jammed thrice in a row while quick closing, window quick raising feature is deactivated. Window learning procedure shall be started when the doors are closed and lock is open. First, bring the window half way or at least one quarter closed position. Then lower the window to the bottom level and press the button until a chaser signal is received.

When the chaser signal is received, bring the window to the top level with a single press and hold the button until off/on feedback is received from the locks. Window learning operation shall be performed separately for driver window and passenger window. These operations shall not be performed together.

#### Quick Window Lowering

When the on/off switch is pressed down for a short time and released, quick lowering feature is activated, and windows are lowered completely automatically.



#### CAUTION

System switches to self protection mode automatically when the window operating switch is pressed frequently.



# OPERATION

## Opening and closing of the vehicle

### Opening/closing the front hood



#### To open:

It can be opened by the ignition key. Turn the key anticlockwise. Raise the hood slightly, pistons shall open the cover.

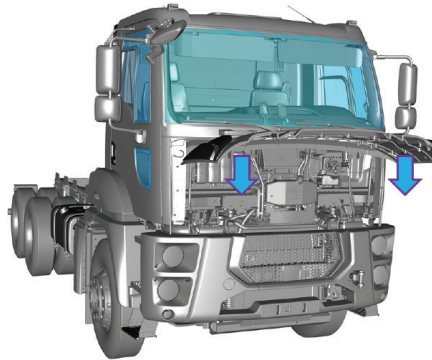

#### To close:

Push to the cover to its original position and press on the locking areas.



#### WARNING

Hold and press the middle of the hood while opening and closing the hood. Do not press on one side of the hood.

# OPERATION

## Cab Ventilation

### Manual Roof Flap

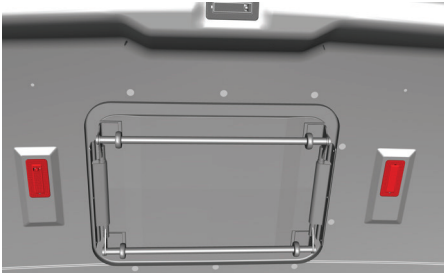

Switching on: Push the cover up by tightly holding the front and rear rods. Opening the cover from rear or front is applied in two different steps. Open front side or rear side or both sides until required level is reached to obtain the required ventilation.

To close: Pull the cover down by holding the rod tightly.

### Power Roof Flap

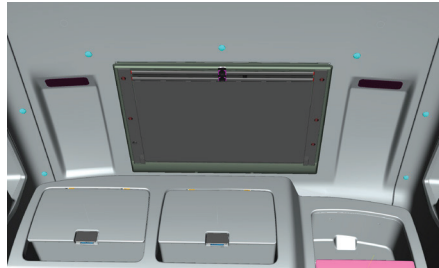

Power roof is controlled by a control switch located in the centre console.

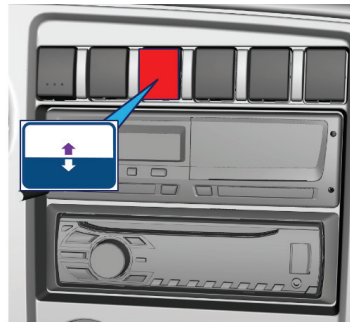

Power roof moves to opening or closing direction while the opening/closing buttons are pressed. Operation is stopped automatically when the power roof reaches uppermost or lowermost position. Buttons are active while the ignition is on. Power roof is closed automatically when the control switch is pressed once for a short period while it is open. Power roof is opened automatically when the control switch is pressed once for a short period while it is closed.

### Air vent with diaphragms

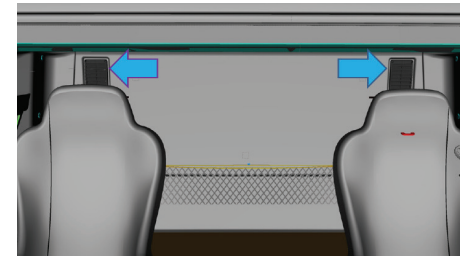

Your cab has a ventilation feature by the vent with 2 diaphragms on the back of the lower bed.

# OPERATION

## Seats and Beds

### Seats



1	Height adjustment
2	Shock absorber adjustment
3	Fast lowering
4	Horizontal yield
5	Fore and aft adjustment
6	Resting position
7	Seat inclination adjustment
8	Seat depth adjustment
9	Armrest
10	Armrest inclination adjustment
11	Heater
12	Backrest adjustment
13	Lumbar support

# OPERATION

## Seats and Beds

### Fast lowering



Seat may be lowered to the lowest position by pressing the button and securing it (before getting off the vehicle).

Seat shall be lifted to the drive position when the button is pressed and released (after getting on the vehicle).

### Height adjustment



Height adjustment is applied in 8 steps.

By pulling or pressing the height adjustment latch, the seat height is changed one step up or down.

When the seat height is changed up or down, lever is released before each step.

### Shock absorber adjustment



The absorbing harshness of the seat may be adjusted without any steps between soft and hard using the harshness adjustment button.

1: Soft absorbing  
2: Middle absorbing 3: Hard absorbing

### Horizontal yield



Operating the horizontal yield may be helpful in some operating conditions. Then, the impacts on the movement direction of the vehicle may be absorbed better.

0: Horizontal yield OFF

1: Horizontal yield ON

### Fore and aft adjustment



Fore and aft adjustment is performed by moving the seat forward or backward while pulling the lock lever. Seat shall be locked with an audible click when the lever is released. Seat may be moved completely forward or backward.

**Do not perform the fore and aft adjustment when the seat is lowered. Seat shall always be lifted for the fore and aft adjustment.**

### Seat inclination adjustment



Pull the button on the left upwards to adjust the seat inclination. Seat may be adjusted to the desired position by applying your weight forward or backward at the same time.



### CAUTION

**Risk of accident!  
Do not operate the lock lever while driving.**

# OPERATION

## Seats and Beds

### Seat depth adjustment



Pull the button on the right upwards to adjust the seat depth. Desired position may be achieved by pushing the seat surface forward or backward at the same time.

### Armrests



Armrests can be raised when required.

### Armrest inclination adjustment

The inclination of armrests on the fore-aft direction can be changed by rotating the button.

The front end of the moves upward when you rotate the button outwards (+ direction), and downwards when you rotate the button inwards (- direction).

### Heater



Electrical heaters on the backrest and seat cushion are operated in two steps by pressing the seat heater switch.

### Backrest adjustment



To unlock the backrest, pull the lock lever upwards. Do not press on the backrest while opening the lock.

You can adjust the backrest by applying or releasing your weight simultaneously. Release the lever to lock again.

- ▶ Backrest shall be secured so that it cannot be moved to another position when it is locked.

# OPERATION

## Seats and Beds

### Lumbar support



Front arch adjustment of the backrest can be customized to the driver by using the front and rear switches (1 and 2). Air chambers are filled when the “+” end of this switch is pressed, and discharged when the “-” end of the switch is pressed.

If the back cushion is not inflated when the “+” of the switch is pressed, this means that the front arch adjustment of the back cushion side supports is complete; release the switch.

Dirt may hinder the operation of the driver seat. Keep your seat clean to prevent this!

Trims are not required to be removed from the seat frame for maintenance.



### CAUTION

**There is a risk of injury if the backrest bounces forward!  
Press the backrest by your hand if the backrest adjustment mechanism is operated while cleaning the backrest trim.**



### WARNING

Discharge the air by pressing the rapid lowering button when you are getting off the vehicle. This would increase the service life of the seat mechanism.



### CAUTION

If the seat is used without air charge, this would damage the internal mechanism of the seat and render the seat out of warranty cover.



# OPERATION

## Seats and Beds

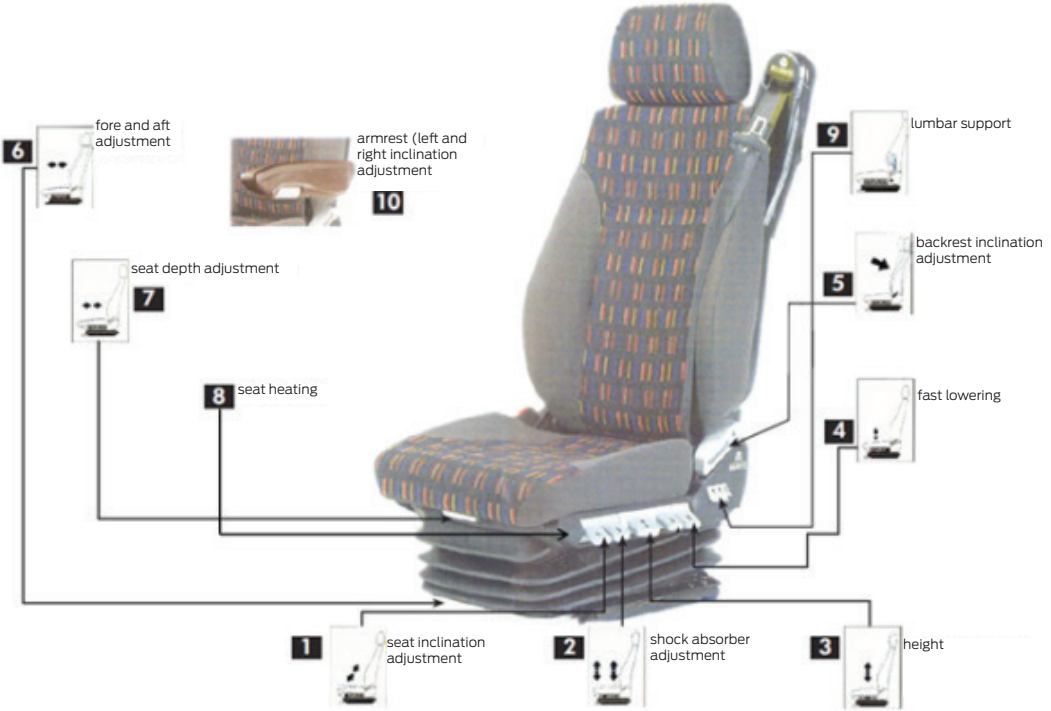

# OPERATION

## Seats and Beds

4

	DRIVER SEAT	PASSENGER SEAT
1- Seat inclination adjustment: Inclination of the seat can be adjusted between 2° and 12°.	YES	N/A
2- Shock absorber adjustment: Shock absorbers can be set in 4 positions from soft to hard with the adjustment button. Absorbers are adjusted to a softer setting when the button is pulled up and a harder setting when the button is pushed down.	YES	N/A
3- Height adjustment: You can adjust the height up and down for 100 mm without any step restriction.	YES	N/A
4- Rapid lowering: Makes getting in and off the vehicle easier. When the driver pulls up the button while he is getting off the vehicle, seat is lowered to the bottom position (by the discharging of air). When the driver gets back in the vehicle, he should push down the button to charge the air bellows of the seat for setting the seat to the driving position. If the seat is used without air charge, this would damage the internal mechanism of the seat and render the seat out of warranty cover.	YES	N/A
5- Seat backrest inclination adjustment: Lean on the seat backrest. Pull the lever up, bring the backrest to the desired position and release the lever.	YES	YES
6- Fore and aft adjustment: It is possible to adjust the seat to fore and aft positions with steps of 10 mm within a limit of 210 mm.	YES	YES
7- Seat depth adjustment: 60 mm. Allows the setting of the depth of the seat within 60 mm in 5 stages.	YES	N/A
8- Seat heating: On/off button can be used to turn on the seat heater. Heater is deactivated after the seat is heated by switching off the button.	YES	N/A
9- Lumbar support adjustment: It may be set to the desired position without any stages.	YES	N/A
10- Armrest adjustment: <ul style="list-style-type: none"> <li>• Armrest can be raised when required.</li> <li>• Armrest height may be set to the desired position without any stages.</li> </ul>	YES	N/A



### WARNING

Discharge the air by pressing the rapid lowering button when you are getting off the vehicle. This would increase the service life of the seat mechanism.



### CAUTION

If the seat is used without air charge, this would damage the internal mechanism of the seat and render the seat out of warranty cover.

# OPERATION

## Seats and Beds

1. Seat back support can be adjusted by front button, seat lumbar support can be adjusted by rear button. Support zones can be inflated by '+' and deflated by '-'



2. Seat cushion angle can be adjusted by adjustment lever. Pull it to adjust and release.

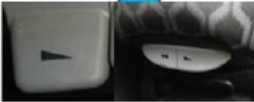

3. While getting off from the vehicle, seat can be taken to the bottom position. All air will be sent out by pushing the latch. Seat will be turn to the previous position by deactivating the latch. **It is recommended to use the seat by air during the drive to prevent seat mechanism from damage.**



4. Vertical impact absorption can be adjusted in different levels by the shock absorber latch for different road conditions. It is recommended to use the seat shock absorber at hard level on bumpy roads in order to provide control on the vehicle and to use soft level at smooth roads in order to increase comfort. Levels increase from upward to downward (from rearside to frontside).  
1- Softer Shock Absorber Level  
2- Soft Shock Absorber Level  
3- Hard Shock Absorber Level  
4- Harder Shock Absorber Level

# OPERATION

## Seats and Beds

### Single Bed

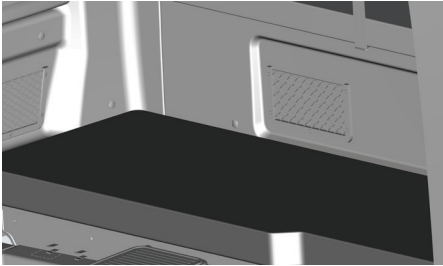

### Upper bed

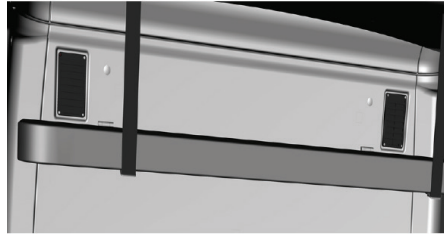

\* Upper bearing is optional for high roof cabs.

Upper bed is tied with a belt.

\* This belt shall be unfastened to open the bed (to bring it to horizontal position).

\* Raising the bed: Bed is raised to the upper position and tied with a belt. Bed is raised to the upper position and tied with a belt.



### CAUTION

Do not carry load or occupants while the vehicle is moving.

There is a risk of injury for both the driver and the passenger as it will be scattered around during braking and manoeuvring.



### CAUTION

Upper bed shall be folded while driving.

# OPERATION

## In-cab storage compartments

### Upper Console (Vehicles with high roof)



There are covered storage compartments on the right and left side of upper console. Press on both sides of the central button to open these covers.



### CAUTION

Do not put heavy items on upper console.

### Glove box

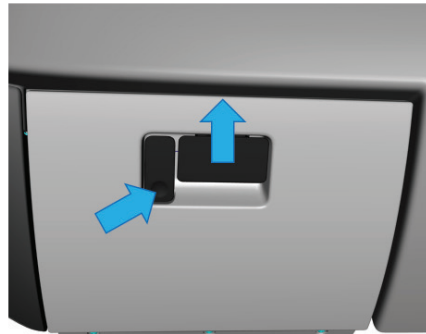

It is placed on the right side of the center console, in front of the passenger seat. Pull the latch towards you to open it.

### Shelves

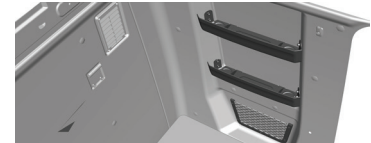

In the rear part of the vehicle, there are 2 shelves and 1 compartment with net both on the right and left. Total weight of the material placed on each shelf shall not exceed 2 kg.

# OPERATION

## In-cab storage compartments

### Centre console

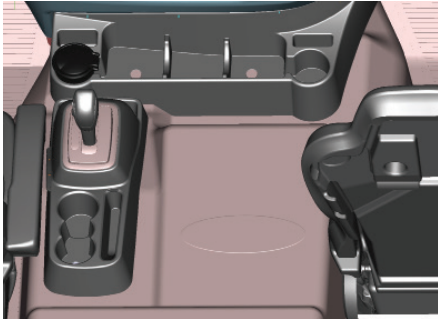

The multifunctional center console placed between the driver's seat and the passenger seat includes and storage compartments for maps, glasses, plastic bottles and other material.

### Ashtray

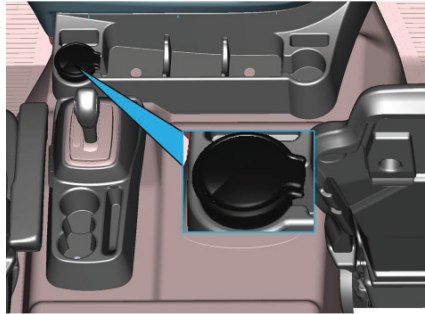

Ashtray is placed on the center of the console. Removable ashtray mechanism provides ease of use in the desired position for the driver.

### Cigar lighter

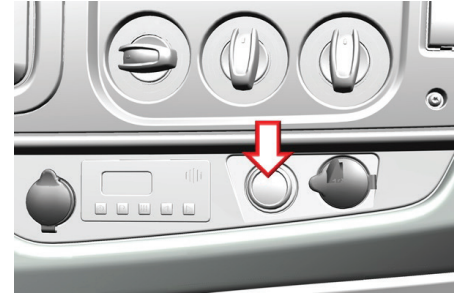

Hold the heated cigar lighter only from its handle. Only use the lighter when the traffic allows you to; otherwise it may distract you and cause an accident.



### CAUTION

24V lighter/power outlet shall be used for operation of the devices other than the lighter.

# OPERATION

## In-cab storage compartments



### CAUTION

Do not touch the cigar lighter end when it is hot.



### CAUTION

Do not hold the cigar lighter element pressed in after it is released.

12 V outlet

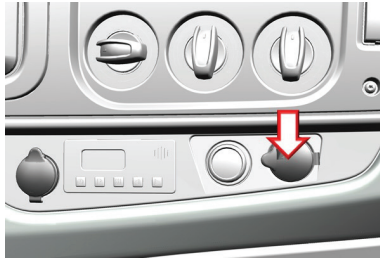

12 V outlet may provide power for devices up to 100W.

24 V outlet



"Electricity for devices up to a maximum of 250 W can be supplied from a 24 V power outlet"

# OPERATION

## Steering

4



You can adjust the steering angle and height in the most comfortable position for you while driving.

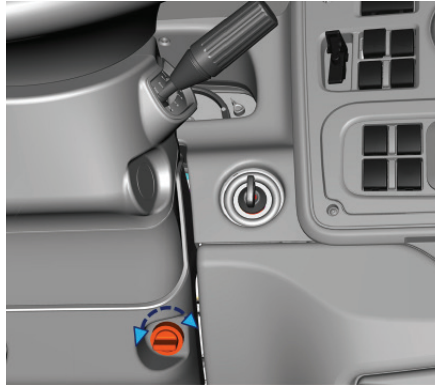

1. Turn the knob on the steering column anticlockwise. Thus, power assist to the system shall be activated and setting shall be allowed.
2. Adjust the steering to a proper position by moving it back and forth.
3. Rotate the knob clockwise without changing the position of the steering.



### CAUTION

A minimum of 7 bar air pressure is required to adjust the steering mechanism. If the vehicle air pressure is low, operate the vehicle to ll up to the air tubes.



### Mirrors



There are 4 different types of mirrors on your vehicle:

- 1- Reversing mirror
- 2- Wide angle mirror
- 3- Kerb mirror
- 4- Front view mirror



### WARNING

Check the settings before operating your vehicle.

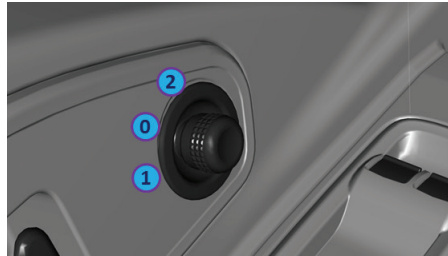

Adjust the rear view mirror (no. 1) by the rotating knob on the driver's door armrest. Bring the knob to **1** position for the adjustment of the driver's side mirror. Adjust the mirror by moving the knob forward and backward and left and right, then bring the knob to **0** position. For setting the passenger side mirror: Bring the knob to **2** position. Adjust the mirror by moving the knob forward and backward and left and right. Bring the knob to **0** position.

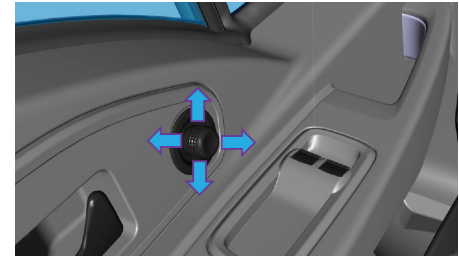

# OPERATION

## Mirrors

### Mirror Heater

4

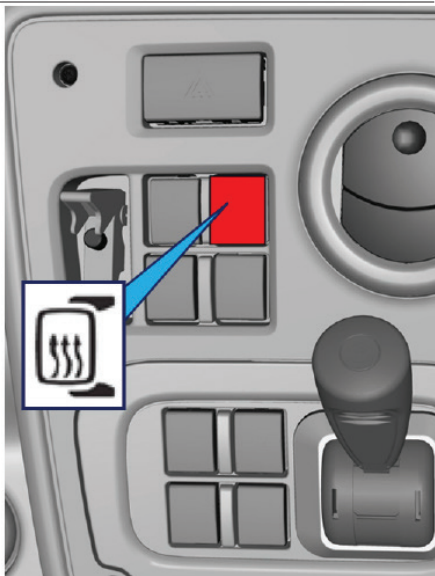

Mirrors 1 and 2 have heaters. Use the heater for ease of view on winter days.

To activate the heater: Press "mirror heater" switch on the control panel while the ignition switch is at position 2.

To deactivate the heater: heater shall be deactivated automatically after 10 minutes.

# OPERATION

## Lighting

### Headlamp Switch



Headlamp switch is placed on the console to the left of the steering.

- 0 – Headlamps off
- 1 – Park lamps and indicator illumination
- 2 – Park lamps, indicator lamps and low beam head lamps Low beam bulbs
- 3 – Automatic
- 4 – increasing the interior lighting brightness
- 5 – decreasing the interior lighting brightness

**CAUTION**

Operating park lamps for a long time while the ignition off causes the battery to discharge.

### Headlamp levelling adjustment



Press the knob in the middle for headlamp levelling adjustment. Knob shall come out as shown in the figure. When you rotate the knob to the left (counter-clockwise) headlamp level shall be lowered, and when you rotate the knob to the right (clockwise) headlamp level shall be raised.

Press the button on the headlamp switch to make it come out. Rotate the button to set it to the required headlamp levelling adjustment. Press the button on the headlamp switch to bring it to the closed position. Headlamp levelling shall be performed as per the load of the vehicle.

**WARNING**

Headlamp levelling shall be adjusted before getting on the road to prevent dazzling the eyes of the drivers of the vehicles in the upcoming traffic in different road conditions.

**CAUTION**

The current capacity of the switch may only cover for the available system. Any additions may cause faults on the switch. If an additional illumination system is installed, additional lamps shall have wiring with relay control. Switch shall only control the relay.

Audible warning signal is heard when the door is opened when the ignition is off and headlamps are on.

# OPERATION

## Lighting

### Autolamps (If Equipped)

#### **WARNING**

The autolamps switch position may not activate the headlamps in all low visibility conditions, such as daytime fog. Always ensure that your headlamps are switched to auto or on, as appropriate, during all low visibility conditions. Failure to do so may result in a collision



When the lighting control is in the autolamps position, the headlamps automatically turn on in low light situations.

**Note:** When the lighting control is in the autolamps position, while passing through viaducts or under bridges, under varying light conditions or during inclement weather conditions headlamps may automatically turn on and off.

**Note:** It may be necessary to switch your headlamps on manually in severe weather conditions.

**Note:** It may be necessary to switch your headlamps on manually while entering some tunnels.

**Note:** If you have autolamps on, you can only switch the front fog lamps on once autolamps has switched the headlamps on.

### Direction Indicator Lever

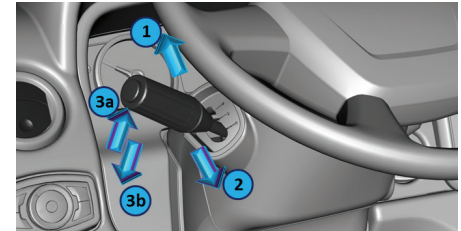

It is placed on the left side of the steering. Switch positions are as follows.

① – Right Direction Indicator

② – Left Direction Indicator

③a – High Beam (Flasher) 

Flasher is operated by pulling the handle briefly and releasing it.

③b – High Beam (Continuous) 

High beam is operated continuously when the handle is released after being pulled at full stroke.

If the direction indicator lever is moved halfway to the ① and ② positions, direction indicators are illuminated for 6 seconds and then automatically turned off. This would increase attention on the road, especially when you are changing lanes.

### Front fog lamp



Front fog lamp is placed on the headlamp control panel. Turn this switch on to obtain better visibility and be visible to the incoming traffic in foggy conditions and where the visibility is low. Front fog lamp icon is displayed on the indicator when the switch is pressed.

### Rear fog lamp



Rear fog lamp is placed on the headlamp control panel. Turn this switch on to obtain better visibility and be visible to the incoming traffic in foggy conditions and where the visibility is low. Rear fog lamps are illuminated when the low and high beam headlamps are activated only. Rear fog lamp icon is displayed on the indicator when the switch is pressed.

# OPERATION

## Lighting

4

### Interior lamp

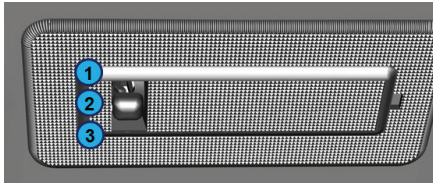

Interior lamp is placed over the windshield on the center area. It is turned on/off by the switch on it.

- ① – Position: Continuously lit.
- ② – Position: Lamp does not turn on.
- ③ – Position: Turns on with any door open.

### Dome (pilot) Lamps

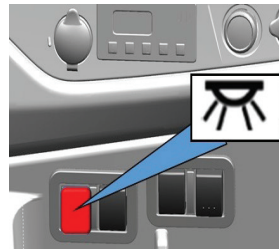
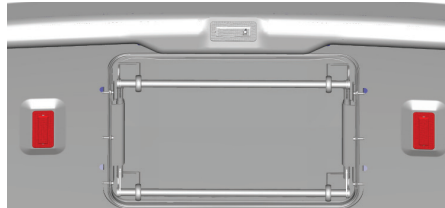

There are 2 pilot lamps, one on the driver side and the other on the passenger side, in the dome of the vehicle interior. These lamps are illuminated by a switch located in the centre console.

### Reading lamp

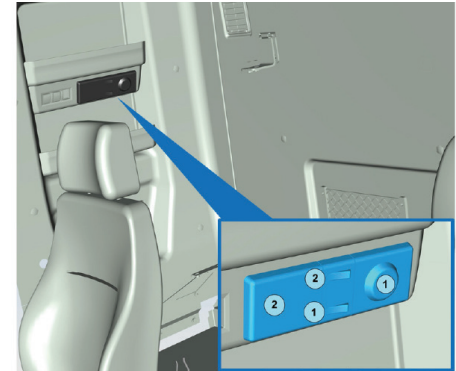

It is placed on the passenger side of bed area. There are 2 buttons on it;

- ① – Turn on/off the round lamp
- ② – Turn on/off the square lamp

Button no. ① on the lower side controls round moveable lamp, and button no. ② on the upper side controls the square lamp on the left side.

### High roof vehicles Interior lamp

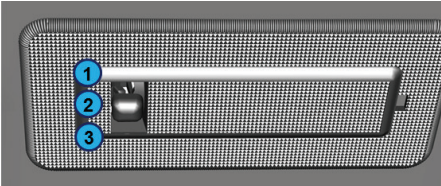

Interior lamp is placed over the windshield on the center area. It is turned on/off by the switch on it.

- 1 – Position: Continuously lit.
- 2 – Position: Lamp does not turn on.
- 3 – Position: Turns on with any door open.

### Dome (pilot) Lamps

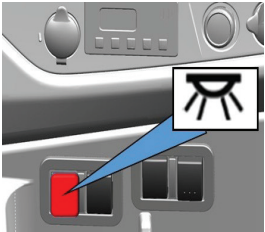

There are 2 pilot lamps, one on the driver side and the other on the passenger side, in the dome of the vehicle interior. These lamps are illuminated by a switch located in the centre console.

# OPERATION

## Window Washing and Heating Systems

### Water spray

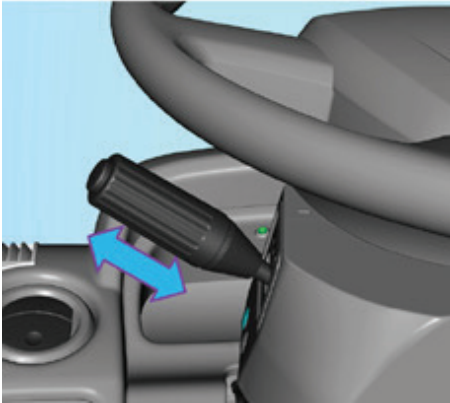

Press on the upper side of the multi-functional handle towards the steering column to spray wiper liquid to the windshield. Water spray function shall be stopped when you release the lever.

### Windshield Washer Reservoir



Windshield washer reservoir is placed on the front of your vehicle. You may access it by opening the hood. Add water and cleaning agent regularly before you run out of washer liquid.

### Autowipers (If Equipped)

The autowipers feature uses a rain sensor. You will find it on the low center part of the windscreen. The rain sensor monitors the amount of moisture on the windshield and automatically turns on the wipers. It will adjust the wiper speed by the amount of moisture that the sensor detects on the windshield.



Wiper switch “Autowipers” position

 When you choose the autowipers position on the wiper switch, wipers will make a single wipe to show you that autowipers are activated. Then, wipers will operate automatically depending on the amount moisture detected on the windscreen.



# OPERATION

## Window Washing and Heating Systems

**Note:** Once you choose a different speed or park position on the wiper switch, autowipers feature will be deactivated, and wipers will operate according to the selected switch position.

**Note:** Fully defrost the windshield before switching on the windshield wipers.

**Note:** Make sure the windshield wipers are switched off before washing your truck.

**Note:** Clean the windshield and wiper blades if they begin to leave streaks or smears. If that does not resolve the issue, install new wiper blades.

**Note:** During driving, if the autowipers operate the wipers slower or faster than you expect, choose most suitable wiper speed manually on the wiper switch.

**Note:** Keep the outside of the windshield clean. Sensor performance will be affected if the blackened areas on the lower center part of the windshield is dirty. The rain sensor is very sensitive and the wipers may operate if dirt, mist or ies hit the windshield.

**Note:** Wet or winter driving conditions with ice, snow or salty road mist can cause inconsistent and unexpected wiping or smearing.

In these conditions, you can do the following to help keep your windshield clear:

- Switch to normal or high-speed wipe
- Switch the autowipers off.

### Windshield Heating (Available on vehicles with Cold Climate pack only)



To activate: press the button on the control panel while the engine is on.  
To deactivate: The resistor will automatically be disabled after 5 minutes. Press the button again to deactivate the heater when it is activated.

# OPERATION

## Circuit Breakers

Use the circuit breakers to disconnect the electrical current in your vehicle.

### Vehicles with ADR

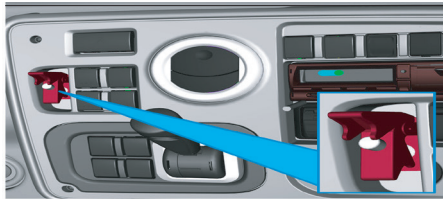

An ADR switch shall be available on vehicles that transport ammable, explosive, combustibile material. ADR switch cuts all electricity of the vehicle off. There are 2 ADR switches on your vehicle; one is inside the cab, and one is outside. Both switches have the same function. To cut the circuit off, it is adequate to turn off one.

### Using the internal switch

#### To cut the circuit off:

Raise the safety cover and raise the switch.

#### To re-activate the electricity supply of the vehicle:

Put the switch down.  
Close safety cover.

### Using the external switch

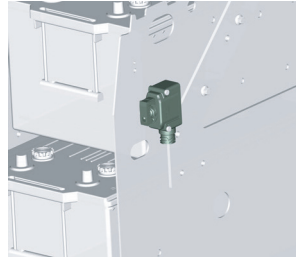

#### To cut the circuit off

Lift the safety cover.  
Raise the switch.

#### To re-activate the electricity supply of the vehicle:

Put the switch down  
Close safety cover.



### CAUTION

Using this switch frequently may damage electronic devices on the vehicle. When any one of the cab interior and exterior breaker switches is activated, some electrical loads are deactivated within 1 second. After 10 seconds, all electrical connection shall be disconnected.

### Vehicles without ADR

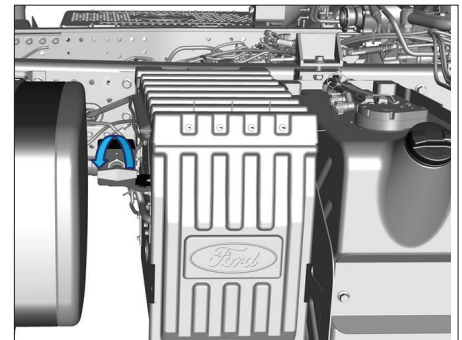
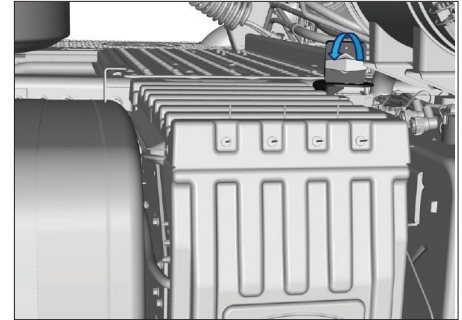

# OPERATION

## Circuit Breakers

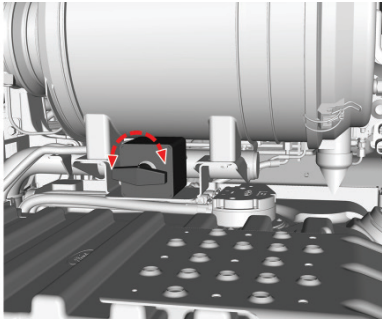

Turn the switch counter-clockwise to cut the circuit off. Turn the switch clockwise to re-activate the electricity supply of the vehicle.



### CAUTION

Use the circuit breaker at least 2 minutes after you have stopped your vehicle. Otherwise, engine electronic control unit (and Denox control unit, if available) may be damaged.



### CAUTION

Disconnect the battery terminals in case of any welding operation on your vehicle. If it is not possible to disconnect terminals, electricity supply shall be cut off with circuit breakers.



### CAUTION

Vehicles with ADR carrying fuel oil and dangerous goods shall always be degassed before entering the service.

# OPERATION

## A/C and Heater

### A/C and Heater



- 1 – Blower speed setting
- 2 – Heat control (hot/cold setting)
- 3 – Blower direction setting

To operate the A/C of your vehicle, bring the heat control



To cold (blue) position while the engine is on.



Press the A/C and recirculation buttons on the front panel.



You can adjust the fan speed in 3 steps.  
0: Off  
1: Low speed  
2: Middle speed  
3: Fast



Adjust the blowing direction



blows to the windshield.



blows from opposite direction.



blows to the leg level and from opposite direction.



blows to the windshield and to the legs.

On hot days, we advise you to open the windows for a few minutes to equalize the temperature inside and outside of the vehicle before turning the A/C on and take some cold air inside the vehicle if the vehicle is moving to obtain better efficiency.

# OPERATION

## A/C and Heater

**NOTE:** To get a better performance from your vehicle's A/C, turn it on even in winter for 5 minutes every 15 days. It is not required to set the knob to cold position during this usage. Mist that forms on the windshield in cold weather conditions may be cleaned much more easily if the A/C and hot air is operated for a few minutes. Then turn the A/C off.

The gas type and amount of the gas used in A/C is printed on the sticker. (Adding oil to the A/C compressor is not necessary unless all gas drains from the A/C. Your vehicle's A/C will not require maintenance under normal conditions. However, we may advise you to remove and clean the fly screen located in front of the radiator periodically to obtain a better efficiency. And replacing the filter that dries air every 3 or 4 years will increase the performance of A/C.



### CAUTION

#### Cabin Air Filter Replacement

Cabin air filter catches the particles in the air incoming to the cabin and ensure that the cabin is free of said particles. If the air flow to the cabin is decreased, the filter shall be replaced before the periodic maintenance intervals. Filter shall be replaced rather than having been cleaned

#### Auxiliary heater Dry Type Heater

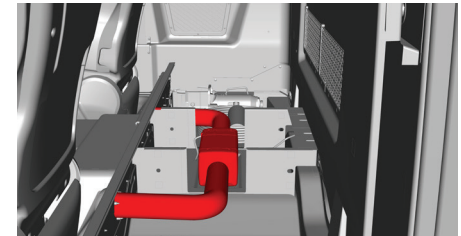

Eberspacher airtronic D2 dry type heater is used. This device is placed under the lower bed inside the cab. Control panel is placed on the center console. Auxiliary heater can also be operated when the ignition is off.



### CAUTION

On vehicles with dry type cab heaters, air may enter to the fuel line and prevent system operation when the fuel level in the fuel tank is decreased to a certain level.

# OPERATION

## A/C and Heater

4

When error codes F01 / F02 / F07 are read on the cab heater digital indicator, fill the fuel level and turn the cab heater switch off and on. Repeat this procedure until the air inside the cab heater fuel system is completely eliminated, and cab heater operates normally.

(Do not turn the heater switch off and on before filling the fuel tank)

When any error code is repeated less than 3 times, cab heater continues to operate normally. However, when (an) error code(s) are repeated more than 3 times successively, cab heater switches to protection mode and indicates an F12 error. In this case, circuit breaker shall be turned off and on again, and thus cab heater shall be reset after refilling the fuel tank. When the reset procedure is completed, cab heater switch shall be turned off and on.

Error F12 may be indicated 1 or 2 times as per the air amount in the cab heater fuel line.

In this case, resetting procedure shall be repeated.



### CAUTION

Pump is delicate. High quality diesel fuel shall be used against freezing. Fuel consumption: 0.7 l/h during the initial start-up when the temperature inside the cab is low; and 0.4 l/h for the operating phase. Blowing temperature from the nozzle is 75°C. Thermostat operates between +5°C and -28°C. Do not cover the blower and the intake nozzle inside the cab. This is important as it affects the service life and the speed of the motor.



### CAUTION

In-cab auxiliary heater hot air outlet is behind the driver's seat. Therefore, dangerous material such as flammable or explosive material shall not be placed between the driver's seat and bed.

### Wet type heater

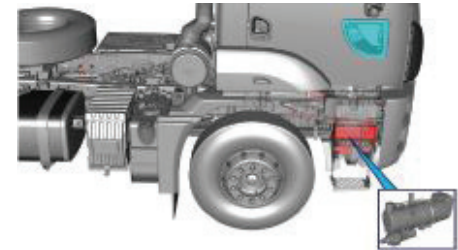

Eberspacher hydronic M2 is used. Cab is heated by heating the engine coolant with diesel fuel. This unit is placed under the right step on the vehicle.

# OPERATION

## A/C and Heater

### Wet type fuel tank

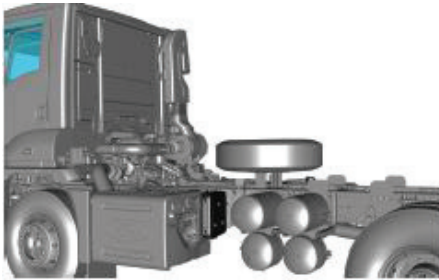

This device has hoses on its own for exhaust and combustion air requirements. It operates with diesel fuel. There is a separate fuel tank on the vehicle. This unit adjusts the cycle automatically and takes fuel from the dosage pump with the help of an element sensitive to the in-cab temperature.

### Controls

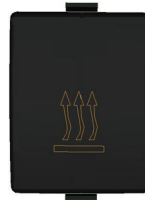

It is controlled by the digital control unit display panel or by the switch on the reading lamp side of the lower bed.



### CAUTION

The unit intakes fuel supply from the specially designed fuel tank that houses the freezing-proof (Arctic Diesel, kerosene etc...) fuel. Turn off additional heating system(s) when refuelling.



### CAUTION

Heater should not be operated in enclosed areas as it produces exhaust gas.

### Malfunction

If the heater has a fault, check the fuse harness for safety. Contact a dealership if the precautions below do not solve the problem.



### CAUTION

The auxiliary heater digital control programming feature is deactivated for safety reasons for the vehicles (with ADR) carrying hazardous substances

# OPERATION

## A/C and Heater

### Auxiliary Heater (EBERSPÄCHER)



#### Main functions of the buttons

With the  button, you may operate the heater or confirm the inputs.

With the  button, you may turn off the heater or stop the functions.

With keys  , you may select the functions and perform settings.

#### Operating the heater immediately

Heating starts immediately if you press the  key 2 seconds.

All functions are ended if you press the  key 2 seconds.



### CAUTION

**Ad** auxiliary unit function It may be activated by Eberspaecher authorized services.

 ventilation symbol is displayed only if the operating unit is connected to heaters that support this function (dry type heaters).



#### Heating

##### Starting the heating operation immediately by pressing the button for a long time

Press the  key for 2 seconds.

##### Starting the heating operation by pressing the button for a short time

Press the  key.

§ Set the desired ambient temperature value (only for dry type heaters) and operating time with   keys, and confirm by pressing the  key.

Press the  key to confirm the values entered.

##### Ending the heating operation by pressing the button for a long time

Press the  key for 2 seconds to end all functions.









##### Ending the heating operation by pressing the button for a short time

When the heater symbol is selected on the screen;

Press the  key; heating shall be ended.

#### Ventilation

##### Starting the ventilation

With   keys, select  symbol from the menu and confirm with the  key, set the operating time with   keys, and confirm by pressing the  key. Confirm the settings by pressing the  key.



### Ending the ventilation operation by pressing the button for a long time





Press the  key more than 2 seconds, all functions shall be ended.







### Ending the ventilation operation by pressing the button for a short time

When the ventilation symbol is selected on the screen; Press the  key; ventilation shall be ended.

### Auxiliary unit

#### Starting the heating operation with the auxiliary unit

With   keys, select  symbol from the menu and confirm by pressing the  key.

With   keys, select  symbol and confirm by pressing the  key.  
§ Set the desired ambient temperature value (only for dry type heaters) and operating time with   keys, and confirm by pressing the  key.

Press the  key to confirm the settings.

### Ending the heating operation with auxiliary unit by pressing the button for a long time





Press the  key for 2 seconds, all functions shall be ended.









### Ending the heating operation with auxiliary unit by pressing the button for a short time

Select the auxiliary unit symbol on the screen,

Press the  key, auxiliary unit shall end the heating operation.

### Starting the ventilation operation with the auxiliary unit

With   keys, select  symbol from the screen and confirm by pressing the  key.

With   keys, select  symbol and confirm by pressing the   key.  
Set the operating time with   keys, and confirm by pressing the  key.  
Confirm by pressing the  key.

### Ending the ventilation operation with auxiliary unit by pressing the button for a long time







Press the  key more than 2 seconds, all functions shall be ended.

### Ending the ventilation operation with auxiliary unit by pressing the button for a short time

Select the auxiliary unit symbol on the screen.

Press the  key, auxiliary unit shall end the ventilation function.

### Program Programming



With   keys, select  symbol on the screen and confirm by pressing the  key. Select one of P1, P2 or P3 programming memories with the   keys and confirm with the  key.

# OPERATION



## A/C and Heater

4





### Activation of the saved program



With   keys, bring the program to "ON" and confirm with the  key.

### Cancellation of a selected program

With   keys, bring the program to "OFF" and confirm with the  key.

### Changing the settings of a selected program

With   keys, select  symbol from the menu bar and confirm with the  key.





Selecting the weekly program mode or day  
With the   keys, select one of the weekly modes, e.g. Mon - Fri, Sat - Sun, Mon - Sun; or select a day, e.g. Mon, Tue, Wed, Thu, Fri, Sat, Sun and confirm with the  key.

Setting travel dates or starting time



Set the hours with   keys and confirm with the  key.

Set the minutes with   keys and confirm with the  key.



### Selecting the operation mode

With   keys, select the heating symbol  or the ventilation symbol  and confirm with the  key.



### Setting the cab temperature (only for dry type heaters)

Set the desired cab temperature with   keys and confirm with the  key.





### Setting the heating level (only for wet type heaters with the automatic operating time function activated)

With   keys, select one of the ECO (economical) or HIGH (high) heating levels and confirm with the  key.



### Setting the operating time







Set the operating period with   keys and confirm with the  key.

### Settings







With   keys, select  symbol from the menu bar and confirm with the  key.

### Setting the time







Select  symbol and confirm with the  key.

Set the hours with   keys and confirm with the  key.  
Set the minutes with   keys and confirm with the  key.

### Setting the date

With   keys, select  symbol and confirm with the  key,  
Set the date with   keys and confirm with the  key.

### Setting the time format

With   keys, select <sup>12</sup> symbol and confirm with the  key.  
With   keys, select the time format and confirm with the  key.



### CAUTION

The auxiliary heater digital control programming feature is deactivated for safety reasons for the vehicles (with ADR) carrying hazardous substances







You may select operating period of your heater as you desire; you do not need to turn on the ignition for unlimited operation. Heater may be operated for the desired period even if the ignition is off.

The main switch button shall not be switched off before the auxiliary heater is halted. If the button is turned off before the heater goes through a certain re-operation period, it may be damaged.

# OPERATION

## A/C and Heater

In the event of a fault the following displays are possible





DISPLAY	DESCRIPTION	REMEDY/CUSTOMER
 <p>INIT</p>	Automatic detection is active. The EasyStart Timer has been disconnected from The power supply and then reconnected.	"Wait until the automatic detection has finished, then set the time and weekday.
 <p>NO SIGNAL</p>	No communication.	"Check and if necessary renew the heater fuse. Visit your vehicle workshop.
 <p>Error</p>	1st heater fault.	Visit your vehicle workshop.
 <p>Error</p>	2nd heater fault.	Visit your vehicle workshop.
	Voltage too low.	Charge battery, if necessary visit your vehicle workshop.
 <p>18:30 - °C</p>	Temperature sensor is defective	Visit your vehicle workshop.





### CAUTION

If you cannot resolve the fault by yourself, please contact your authorized service.

Entering the service menu to learn the error code:

With the   keys, navigate to  symbol on the start screen, and enter the settings menu with the  key.

Press and hold the  key for more than 5 seconds in the settings menu. Code shown in the menu no.1.1.1 on the screen is the error code for heater no.1. If there is a 2nd heater in the vehicle, navigate to menu no.1.1.2 with the  key to see the error code for heater no.2.



### WARNING

Service menu shall only be used for displaying the error code. Changing the settings on the service menu may damage your heater. Please use the service menu for displaying the error code only.

### Heater Turns Off By Itself

Fault Description	Remedy
Does not ignite during operation	Turn the heater off and on once
Flame goes off during operation	Turn the heater off and on once
Heater overheats	Check for blockage in the air input and output channels. Then cool down the heater and turn the heater off and on once.
Voltage value of the vehicle is inadequate	Check the heater. Turn the heater off and on once.

# OPERATION

## A/C and Heater

### Heater

4



Bring the heat control to red position for hot air ow.

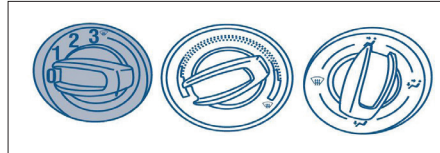

You can adjust the fan speed in 3 steps.

- 0: Off
- 1: Low speed
- 2: Middle speed
- 3: Fast

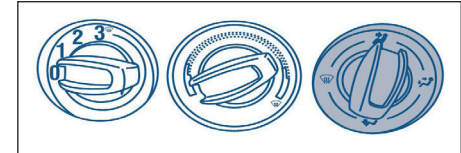

Adjust the blowing direction



blows to the windshield.



blows from opposite direction.



blows to the leg level and from opposite direction.



blows to the windshield and to the legs.

### Before taking off:



Check the air pressures on the brake circuits.

### Starting the engine

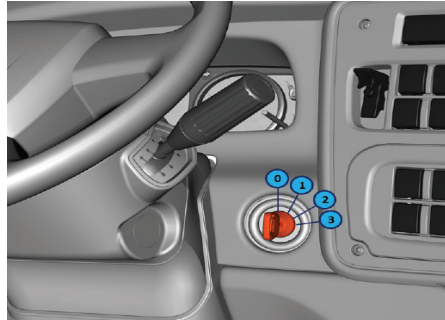

Turn the ignition on.

- Turn the ignition switch to position **2**. Wait until the engine warning lamp is turned off. refer to maintenance and service chapter MIL lamp
- When gear idle, (press clutch for manual transmission vehicles) and. Start the engine by turning the ignition switch to position **3** (max.10 seconds)
- Wait for 15 seconds if the engine does not start and repeat the same procedure in the same order.



### CAUTION

Wait for the period determined by the electronic control unit (10 to 40 seconds) before starting again after a start failure. Do not attempt to start in this period.

### Cold Start

- Turn the ignition on. (position **2**). Cold starting lamp will be continuously on 
- Start the engine (position **3**) when the cold start lamp turns off,
- We advise you to apply the clutch pedal to lower the load on the engine.
- If the engine does not start, switch the ignition off, wait for 1 minute and repeat the steps above.

# OPERATION

## Driving

### Starter Protection System

Starter Protection System is a system that prevents the burning of the starter due to unnecessary starting operations. Electronic control unit calculates the maximum appropriate duration of a starting operation by gathering many data via the sensors on the engine to protect the starter. When the user exceeds the specified maximum start duration, he is prevented from starting again. The system allows starting again at the end of the period determined by the electronic control unit. Please follow the instructions below in such a case.



### CAUTION

If your engine is not started after some attempts, there may another problem in another system of your engine. First complete the other checks, and attempt to start again.

### To stop the engine

Do not stop the engine immediately when the vehicle is stopped. Wait until the turbo speed is decreased by operating the engine in idle. If the engine is stopped immediately when the vehicle is stopped, the turbo which is rotating in high speed shall not be adequately lubricated.



### CAUTION

Applies for Tractors and Road Trucks. Fixed spoilers are provided on Construction series.

### Air deflector

Adjust the air deflector on the cab according to the trailer.

Note: A correctly adjusted air deflector reduces the fuel consumption.

There is a risk of falling down from the cab and being injured while adjusting the air deflector. We advise you on that adjustments on the air deflector shall be performed by FORD OTOSAN authorized dealership with the required expertise and special equipment.

### Smart acceleration feature:

Acceleration of the vehicle is controlled by limiting the engine acceleration profile to a specified percentage of the maximum weight that can be carried by the variant for trucks, and maximum load that can be drawn for the tractor trucks.

Abrupt and unintentional accelerator responses of the unloaded vehicle have been prevented, and thus driveability of the vehicle is improved besides providing fuel economy. Smart acceleration function is deactivated especially in uphill start and climbing manoeuvres and it is optimized to prevent adverse effect on the vehicle performance.



### Cruise Control

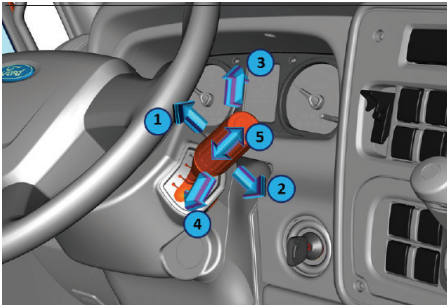

Pull the lever towards you to activate,



(position 1) shall be displayed on the indicator.

- 1 - Increasing the speed
- 2 - Decreasing the speed
- 3 - Deactivation
- 4 - Engine brake and retarder
- 5 - Resuming cruise control

Driving speed is set by the multifunction lever on the right of the steering. Engine electronic control unit adjusts the throttle setting required for driving the vehicle at the set speed. Vehicle is driven in the set speed without the need for the driver's applying the accelerator pedal.

When the cruise control is activated, it is automatically deactivated in the following conditions:

- Applying the brake
- Applying the clutch (in vehicles with manual transmission)
- In case activating the engine brake, cruise control is deactivated automatically

When cruise control is activated, it is shown as figure depicted below on the cluster information menu.



### CAUTION

Vehicle cuts throttle if the set speed is exceeded, and engine brake is activated if the engine speed is over 1000 rpm.

- Cruise control cannot be activated for vehicle speeds under 30km/h.
- Cruise control cannot be activated for vehicle speeds over the speed limit.
- Cruise control is deactivated automatically if it is active when speed limit is exceeded.
- For convenience of use, cruise control remains active until gear is changed when the clutch is applied for 5 seconds in vehicles with manual transmission.

# OPERATION

## Driving

### Hill holder

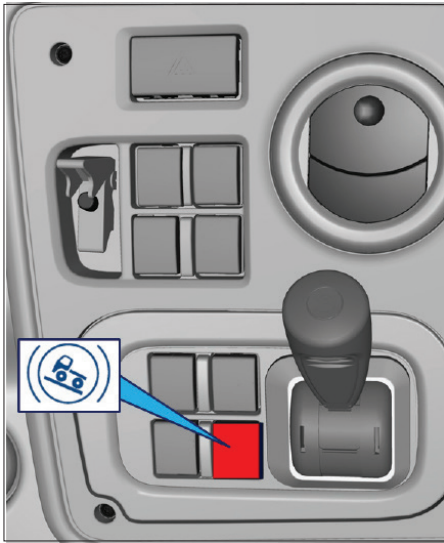

4

### On Vehicles with Manual Transmission:

- 1- Stop the vehicle with service brake.
- 2- Activate the hill launch assist by pressing the button on the center console.
- 3- Depress the clutch pedal.
- 4- Engage proper starting gear.
- 5- Release the brake pedal, brakes of the tractor and semi-trailer holds automatically.
- 6- Release the clutch pedal to drive off the vehicle and press the accelerator
- 7- Hill holder feature,

• is deactivated automatically when the clutch is released or engine torque reaches a specified value.

### On Automated Manual Transmissions:

- 1- Stop the vehicle with service brake.
- 2- Activate the Hill holder by pressing the button on the center console.
- 3- Release the brake pedal.
- 4- Hill holder holds the brakes for a maximum of 2,5 seconds. If the engine torque reaches the specified level earlier, Hill holder assist is deactivated before 2,5 seconds

hill start assist active warning is displayed on the instrument when the hill start assist is active

### Disc brake system

Brake System: Arvin Meritor Elsa 225H air disc brake with sliding brake calliper.  
 Disc: 430 mm anti-conical disc with air ducts. System Air Pressure: 10,5 bar

### Brake friction pads

The new brake pad thickness is 19mm. Brake pads should be replaced when they fall to 3 mm thickness. Vehicles with disc brakes have a sensor on each brake that constantly measures the amount of wear. The display screen shows how many kilometers the pad of the brake pad on each axle will go in <<KM>>. Data is collected for a predetermined period of time based on the driver and usage conditions, and is displayed on the display as an hourglass. Different wear between right and left brake pad, brake pad sensor error, general error, remaining brake pad life under 6% and installing worn brake pad under 35% are shown on the display in <<---->> and the problem should be solved by going to service. When the amount of brake lining in any brake approaches the end, the driver is informed with the warning light. After the warning light turns on, the problem should be solved by going to the nearest service

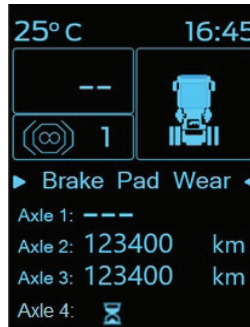

Weared lining information is shown on the display. On which axle the brakes shall be replaced can be seen on the display. Linings of both left and right brakes on the relevant axle shall be replaced at the same time.

An indicator lever is available on the brake to allow monitoring of the lining thickness besides the percentage indication on the display. Linings shall be replaced when the indicator lever is fully worn. As the service life of the lining shall differ greatly due to causes such as vehicle load, operating conditions etc., monitor the lining thickness periodically from the display or check it every month with the indicator lever on the brakes when it is not possible to monitor it from the display.

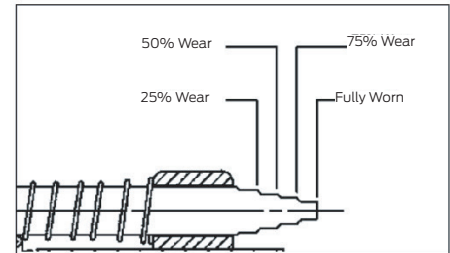
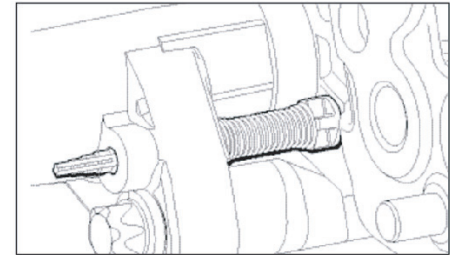

# OPERATION

## Braking

4

The thickness of the new discs is 45 mm. Discs shall be replaced when the thickness becomes lower than 39 mm. Check the disc thickness every three months as the service life of the disc shall differ greatly due to causes such as vehicle load, operating conditions etc. Inspect the disc surface against cracks during thickness inspection.

Replace the disc if the cracks on the surface has reached air ducts or grown up to 25% of the lining pressure surface. Cracks that have not grown up to 25% of the surface do not affect the performance, you may continue to use the disc.

Blue areas on the disc surfaces indicate that they have been subject to excessive heating. We recommend you to machine the disc as the structure of these areas have been deformed. Linings that have been subject to excessive heating shall also be replaced.

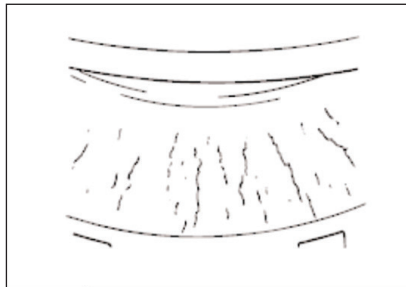
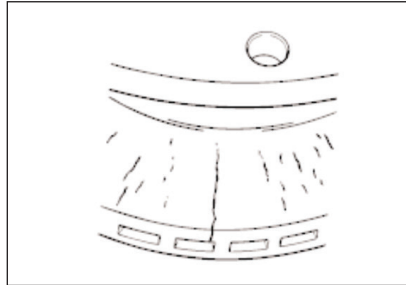

### Drum Brake System

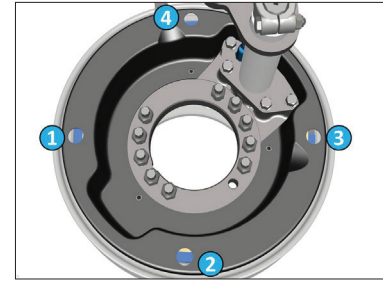

Z-cam brake system is a lining-drum type braking system. Brake lining wear is inspected from 4 holes on the brake plate. Remove the plugs on the plate for inspection, and replace them after inspection.

\*Z-cam brake system is optional.

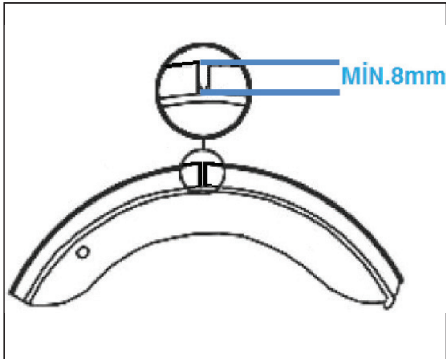

Lining wear inspection may also be performed visually from the inspection holes on the brake dust plate. If the thickness of the lining remaining on the brake pad is less than 8mm, we recommend that you shall have your lining replaced in a Ford authorized service immediately.



### CAUTION

Even if one of the mutual linings is worn, replace both linings.



### CAUTION

Install the plugs again after lining inspection. Otherwise, dust and dirt ingress between the lining and drum may cause premature lining wear and damage to the drum.

# OPERATION

## Braking

### Emergency brake bellows

Brake air bellows on the drive axle of your vehicle have emergency feature. Emergency bellows are activated in 2 conditions:

- When the park brake is applied
- When there is not enough air in air tubes to brake the vehicle



### Discharging the emergency bellows

To discharge the emergency bellows, turn the bolt behind the bellow in tightening direction (clockwise) completely.



#### CAUTION

Install the plugs again after lining inspection. Otherwise, dust and dirt ingress between the lining and drum may cause premature lining wear and damage to the drum.



#### CAUTION

To start park brake mechanism again, please contact to the authorized workshops or refer to the repair catalogue. If the vehicle is going to be parked for more than one month, perform the following to protect the linings and drums.

- Park the vehicle, chock the wheels and release park brake lever.
- Drain air tanks completely.
- Release the park brake unit as specified depending on the vehicle model.
- Run park brake unit and refill the system with air when you will drive the vehicle again.

### Engine brake (Standard)

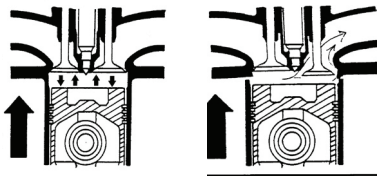
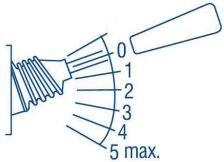
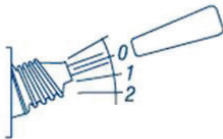

Figure-1

Figure-2

Your engine provides the engine brake feature as standard. At the end of the compression cycle (Fig. 1), before several degrees from the Top Dead Center, a special equipment in engine pistons opens the exhaust valves a little and releases the pressure grown inside the cylinder (Fig. 2). Thus, braking torque of the compression cycle is used.

### Activation of the engine brake



	Engine Brake
1. Range	Reduced Brake Power
2. Range	High Brake Power

Engine brake is activated by the lever on the right of the steering.

 warning is displayed on the indicator.

### Retarder / optional

Retarder is a special brake system for decelerating the vehicle and maintaining the speed in downhill travels, and also known in the market as "drive shaft brake" systems. Retarder provided in your vehicle has a hydrodynamic braking system also known in the market as uid type.

- Braking Moment: 3650 Nm
- Braking Power: 500 kW
- Weight: 52 kg .
- Operating principle: Hydrodynamic braking
- Fully compliant with ABS-EBS system

Retarder is activated by the 5 step lever on the right of the steering.

	Engine Brake	Retarder
Bremsomat	Reduced Brake Power	Bremsomat (0%-100%)
Bremsomat	Reduced Brake Power	25% Max. Brake Power
Retarder 2	Reduced Brake Power	50% Max. Brake Power
Retarder 3	High Brake Power	75% Max. Brake Power
Retarder 4	High Brake Power	100% Max. Brake Power

 warning is displayed on the display when the retarder is activated. Bring the retarder lever to 0 (off) position when the required speed is reached. When the retarder lever is pulled, rear brake lamps are turned on when the vehicle reaches a specified braking power. (-0.7 m/s<sup>2</sup>).

# OPERATION

## Braking

### Bremsomat:

When the retarder lever is pulled 1 step while driving downhill, retarder is activated in the required amount so that the vehicle speed hold constant.

Bremsomat feature turns off when the lever is brought to 0 or any position from 2 to 5.

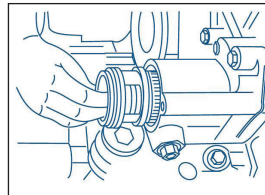
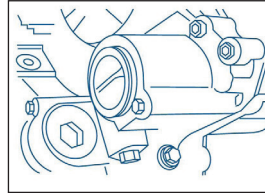

### WARNING

Retarder oil is cooled with the engine coolant. Check whether the coolant is heated excessively from the coolant temperature indicator especially when the retarder is used in long intervals.



When the coolant has reached 105 °C, retarder is deactivated automatically to prevent excessive heating of the engine.



### CAUTION

Retarder braking force has a technical limit.

In Bremsomat position, force acting downhill due to the road inclination and load status may exceed maximum braking force of the retarder. In this case, vehicle shall be accelerated.



### CAUTION

Do not use pressurized water to clean the retarder unit. Pressurized water may cause harm to the valves, sensors and breathers.



### CAUTION

Retarder requires maintenance. The oil filter should always be changed at every replacement interval of the transmission oil.



### CAUTION

Using retarder for any type of deceleration will extend service life of the brake linings.



### Automatic hybrid brake mode

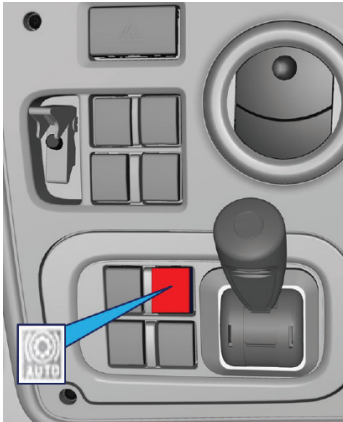

In the automatic mixed brake mode, when the brake pedal is pressed, the service brakes as well as the retarder and engine brake are activated in proportion to the amount of pedal pressed. This feature can be deactivated by pressing the "AUTO" button on the center console. When the vehicle is started, automatic combined brake mode is activated. You may disable the function by pressing the "AUTO" button. Combined

brake mode shall be activated when the ignition is turned off and on again. Retarder is not included in the standard vehicle package, it is optional. When the vehicle is started, automatic combined brake mode is activated. You may disable the function by pressing the "AUTO" button. Combined brake mode shall be activated when the ignition is turned off and on again.



### CAUTION

If the right multifunction lever is brought to any position other than (0), automatic hybrid brake mode is deactivated until the lever is brought to position (0) again.

### Air tubes

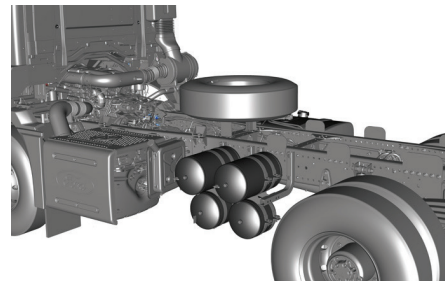

Drain the water in the tanks every day. Pull the ring attached to the cock until all air is discharged to drain the water inside the tanks.

When the air tanks are drained, low pressure warning should sound as the ignition is switched on. If the warning system is not operated due to a fault on the warning circuit, the fault on the system should be repaired immediately. Do not drive your vehicle until the normal pressure is displayed on the air pressure indicators. Air drier filter may be not operating if greasy mud deposit is seen during the air tank draining procedure. Replace the filter of the air dryer.

# OPERATION

## Braking

### Air Dryer (APU)

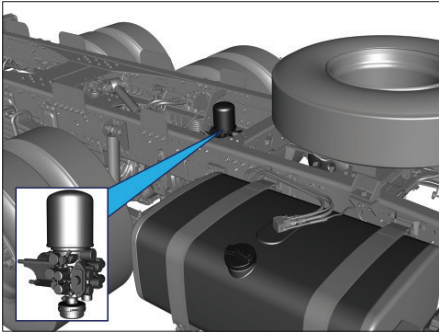

The air drier unit on your vehicle includes air heating, separating the oil in the air, air discharge and 4-way relief valve functionalities besides the air drying function. A tire inflation port is available on the air drier inside the chassis.



### CAUTION

Air drier filter shall be replaced in periodical maintenance intervals. If the drier filter does not operate properly, it may cause damage to itself and the air valves.

### Auxiliary Air Line

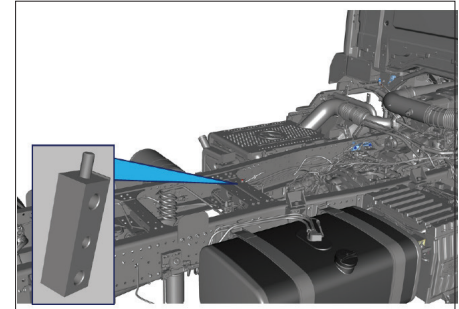

When air bleeding is required for special functions (e.g. air horn, air gun), connection shown in the figure shall be used.



### CAUTION

Do not take air directly from the tubes.

### Reverse test request



There are some kind of failures which can't be detected by EBS directly, only via monitoring of the behavior of the vehicle

and the brake system. These monitoring functions are called plausibility checks. If a plausibility failure is detected by the EBS, it can be restored according to the legal requirements only if EBS carries out system test (called reverse test) and the result of the test is positive (operation of the brake system is correct). It means when the cause of the failure is eliminated (it was just a temporary failure, or the vehicle is repaired), than a reverse test has to be carried out.

To make EBS to be able to carry out the reverse test, the driver has to activate the brake pedal once under a defined condition. When EBS requires such a pedal activation to restore the failure, it will send a request with the following failure code:

Path: 253 (Vehicle brake system) Type: 201 (Press brake pedal request) (SPN 64969)

It is highly recommended to give a clear text on the instrument cluster to the driver when this pedal activation requested and the user manual of the vehicle should describe clearly the conditions how to do it.

The pedal activation has to be carried out on the following way:

After fault detection, the ignition must be switched off and on in order to reset EBS:

- The ignition-off phase must be at least 5 sec., to allow power-down of EBS, and
- During ignition-off phase the brake pedal must be released, to avoid braking in wake-up mode without reset of EBS.
- After ignition is switched on, for at least 7 sec.:
- The vehicle must be in stillstand, and
- Brake pedal must be released.
- Supply voltage EBS sufficient for electronically controlled braking.
- Parking brake should be released in case of TCM failures.
- Warning lamp is on, system restriction is active.
- Brake pedal actuation, with the following features:
- During standstill, the driver is instructed via dashboard symbol "braking" to do a braking.
- Pedal actuation does not start before 7 sec. after ignition is switched on.
- Pedal actuation must increase to full brake position, without any condition.
- Full brake position must be hold for at least 3 sec..

- Pedal decrease until fully release, without any condition.
- Brake pedal must be fully released for at least 3 sec..
- Warning lamp is on. System restriction is not active during braking. Braking is controlled by electronic pressure control.

### Brake pedal test is successful:

- No fault is detected during the braking.
- Warning lamp is switched off, system restriction remains not active.

### Brake pedal test is not successful:

- A fault is detected during the braking, or
- Maximum braking time of 25 sec. is expired, or
- The vehicle starts moving.
- Warning lamp remains on, system restriction is activated.
- An ignition reset is needed to start brake pedal test again.

# OPERATION

## Shifting

### Manual transmission and shifting

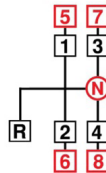
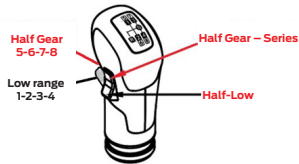

There are 16 forward and 4 reverse (in high and low ranges) gears. All gears other than the reverse gears have synchronizers. Shifting from low to high range and selection of half (boost) gears is made via the latches on the gear knob. As shown in the diagram below, the latch in the front side of the gear knob allows selection of the low range (1-2-3-4) and the high range (5-6-7-8). When the latch is down, the transmission is in the low range; and when the latch is up, the transmission is in the high range. The latch on the side of the gear knob allows selection of half (boost) gears. When the latch is down, the transmission is in boost gear; and when the latch is up, the transmission is in normal gear.

Note: To shift from low range to high range during acceleration in transmissions with 1H gear system:

1. Press the latch upwards in the 4th gear.
2. Depress the clutch pedal.
3. Select neutral.
4. Shift the lever from neutral to 1/2 range and then 1/5 gear.
5. Slowly release the clutch pedal.
6. Leave the latch in high range.

Transmissions have a shift prevention mechanism to protect the transmission against incorrect shifts when the vehicle has reached a certain speed. These mechanisms prevent shifts to 1/2 range in certain speeds for low and high ranges, and shifts from high range to low range.

Below are the cases reflecting the above mentioned circumstances and where the protection mechanisms are activated for errors likely to be experienced when driving:

- 1- Driver wants to shift from 4th to 5th, but forgets to switch the latch to high range (upwards) when the vehicle is accelerating: The gear knob cannot be moved to 1/2 position, changing to an incorrect gear is prevented by the system.
- 2- Driver wants to shift from 6th to 5th, but switches the latch to low range inadvertently when the vehicle is decelerating: As the transmission will try

to shift to 1st in this condition, the shift prevention mechanism is activated and prevents the shift operation, and moves the shift lever to the 3/4 range, and changing to an incorrect gear is prevented by the system.

- 3- Trying to shift from 8th to 5th when the vehicle is moving with a certain speed: Selector lever!

The gear knob cannot be moved to 1/2 position, changing to an incorrect gear is prevented by the system.

- 4- Trying to shift from low range to high range when the vehicle is moving with a certain speed: System denies the shift to the low range. Driver is not allowed to shift to low range.

Prevention mechanisms of the 16 S 2230 transmission specified above are intended to protect the gear and synchronizer mechanisms in the transmission, and these are not error modes.



### CAUTION

Service life of the clutch is proportional with its correct usage. Incorrect usage of the clutch reduces its service life and clutch is damaged because of overheating in a short period of time. Do not hold the vehicle on slopes with semi-applied clutch.

In order to shift into gear, fully press the clutch pedal before shifting and remove your foot when shifting occurs. Do not hold your foot on the clutch pedal on driving conditions where operation of clutch is not required. Choose a lower gear during take-off to ensure that your clutch has a longer service life. In case of any load, take off with low range 1 on hills, and high range 1 gear on straight roads.



### CAUTION

Do not take off with your vehicle when the vehicle is loaded and the transmission is in high range. Stop the vehicle completely to engage reverse. Wait for 8 to 10 seconds, and shift into reverse. Your vehicle's transmission may be damaged if you try to shift to reverse when the vehicle has not come to a complete stop.

Do not shift to neutral while driving down a slope.

Do not take off with your vehicle when the transmission is in high range

Do not use reverse gear when the transmission is in high range. Do not use your vehicle in neutral. Transmission may be damaged as the lubrication inside the transmission while the vehicle is moved in neutral for a long time will be inadequate.

### Eaton ESO14409 Manual transmission and shifting



It has 9 gears: 8 forward + 1 crawler gears.

First 4 gears are called as low range, and the remaining 4 gears are called as high range. Switching between low and high ranges is provided by the up and down movements of the latch on the gearshift lever. As shown below, the transmission will operate in the low range when the latch is pressed downwards,

and in the high range when the latch is pressed upwards.

- During the acceleration, to switch from the low range to high range:

1. Press the latch upwards in the 4th gear.

2. Depress the clutch pedal.

3. Select neutral. (Planetary gear set will be disabled then, and the transmission will shift to high range)

4. Shift the lever from neutral to 1/2 range and then 1/5 gear. Transmission will shift to 5th gear when it is in high range.

5. Slowly release the clutch pedal.

6. Leave the latch in high range.

- Transmissions have a shift prevention mechanism to protect the transmission against incorrect shifts when the vehicle has reached a certain speed. These mechanisms prevent shifts to 1/2 range in certain speeds for low and high ranges, and shifts from high range to low range.

# OPERATION

## Shifting

4

• The situations that the driver may experience with the prevention mechanisms are listed below:

1. Driver wants to shift from 4th to 5th, but forgets the switch the latch to high range (upwards) when the vehicle is accelerating: Shift lever cannot be shifted to 1/2 range and the driver is warned about this.

2. Driver wants to shift from 6th to 5th, but switches the latch to low range inadvertently when the vehicle is decelerating: As the transmission will try to shift to 1st in this condition, the shift prevention mechanism is activated and prevents the shift operation, and moves the shift lever to the 3/4 range, and driver is warned about this.

3. Trying to shift from 8th to 5th when the vehicle is moving with a certain speed: Shift lever cannot be shifted to 1/2 range and the driver is warned about this.

4. Trying to shift from low range to high range when the vehicle is moving with a certain speed: System denies the shift to the low range. Driver is not allowed to shift to low range.

• Prevention mechanisms of the transmission specified above are intended to protect the gear and synchronizer mechanisms in the transmission, and these are not error modes.

### Transmission Information on the display:

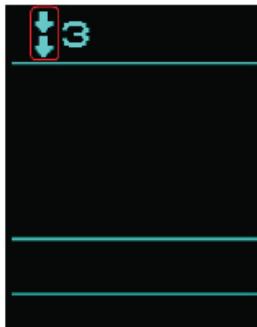

Engaged gear is displayed on the upper left corner of the trip computer.

D: forward gear

R: Reverse

Example: D4 Forward 4th gear

▽ Downshift

▽ Downshift 2 gears



"Shift up" warning: engaged gear is smaller than required by the engine speed. Shift up.



**CAUTION**

Driving in lower gears than required increases fuel consumption. As the engine speed shall be higher in smaller gears, it will tire the engine more.



Shift up when warning is displayed on the display.



**CAUTION**

On vehicles with a manual transmission, do not travel by keeping your hand on the gear lever, the pressure applied on the gear lever may slightly damage the gear internal mechanism.

### Automated transmission and shifting

It is used in transmissions with 12 forward and 2 reverse gears and with 9 forward and 1 reverse gears in Ford Trucks vehicles with automated transmission; and in transmissions with 16 forward and 4 or 2 reverse gears and with 9 forward and 1 reverse gears in Ford Trucks vehicles with automated Ecotorq transmission. No clutch pedal is available in the vehicle. Clutch release/clutch operation is performed by the mechanism controlled by the electronic control module.

### System components

#### Shift Lever:

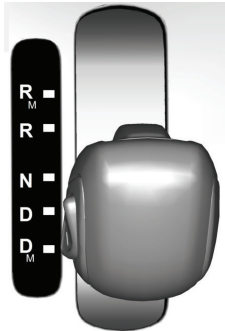

D: forward gear

N: N/A

R: Reverse Gear

DM: Forward Manoeuvre (only used while coasting)

RM: Reverse Manoeuvre (only used while coasting)

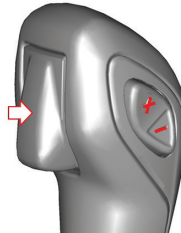

Up/Downshift will be done with +/- buttons where is on the shift knob. Drive -Manual toggling will be done whether driver pushes the minus or plus button more than 1 sec.

Locking mechanism enables to have secure shifting movement between each gates, prevent to shifting N to D or N to R mistakenly.

### Information Display:

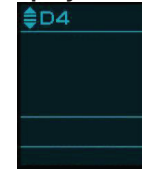

### In automatic mode

Engaged gear is displayed on the upper left corner of the trip computer.

D: forward gear

R: Reverse

Example: D4 Forward 4th gear

### In Manual mode

▽ Downshift

▽ Downshift 2 gears

### Automatic and Manual Operation:

**Automatic:** Transmission electrical control unit selects the best gear according to the engine and load status. Gear selection and shifts are performed automatically. False gear selection is not possible.

\* Transmission decides take-off gear and gearshifts.

\*: Automated transmission is not provided in standard vehicle package; it is optional.

\*\* : Transmission model code can vary according to the features such as PTO and/or retarder.

# OPERATION

## Shifting

### Automatic and Manual Operation:

Automatic: Transmission electrical control unit selects the best gear according to the engine and load status. Gear selection and shifts are performed automatically. False gear selection is not possible.

Transmission shifts to most economical mode if engine brake is not activated (low engine speed)

If the engine brake is activated, transmission shifts down to increase engine speed. Clutch movement and shifts are performed automatically. Gears may be corrected manually. False shifting is not possible.

### Initial operation (lifting the vehicle)

#### Moving the Vehicle

Make sure that the air is filled up adequately. You can tell whether the air is filled or not by the air pressure section of the instrument panel. Or you may wait until the driver's seat is completely filled with air. If the driver's seat is filled with air, this means that there is enough air for the transmission.

AL warning shall be displayed on the screen if the air in the vehicle is inadequate.



### Shift to D for moving forward



When you shift to D, the transmission shall start in automatic drive mode and shall select the starting gear itself, depending on load and inclination. D shall be displayed on the screen, indicating that the vehicle is started in automatic mode.



### WARNING

In some cases, the transmission software may not be able to calculate the starting gear (when the vehicle is started recently, when no information received or due to calculation errors). If you think that the transmission can not select the appropriate gear according to the vehicle load and the inclination of the road, you may change the take-off gear with the + and - commands on the shift knob. (Max. 6th gear may be selected for take-off) Before moving, observe that the transmission has selected the gear on the display

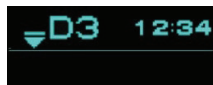

Release the park brake and press on the accelerator slowly. Transmission shall slowly release the clutch and allow the vehicle to move.



### CAUTION

If the vehicle is on a slope when you release the park brake, it may slip backwards or forwards if you do not press the accelerator. Keeping the vehicle uphill and slightly depressing the accelerator pedal shall cause the transmission to half-clutch, the clutch shall start to slip and it shall warm up.



CL shall be displayed on the screen if the clutch is overheated. If you see this warning, either press on the accelerator a little to allow the vehicle to move or press on the brake to hold the vehicle. Otherwise, clutch may burn out on early mileages.



If you see the CW warning on the screen, this means that the clutch is worn out. Vehicle shall not move in such a case. Call the authorized workshop.

### Using in Manoeuvre Mode

The automatic transmission has manoeuvring modes to move the vehicle forward and backward precisely. When in the manoeuvre mode, the transmission does not close the clutch fully or closes the clutch in a very long time than normal. This prevents the vehicle from moving forward abruptly and provides driving safety in approaching manoeuvres that require precise movement



Switch to DM to use the vehicle in forward manoeuvre mode, and to RM to use the vehicle in rearward manoeuvre mode. Manoeuvre modes are not auxiliary shift modes, they may cause damage to the clutch by overheating the clutch when the vehicle is operated under load or on a slope for a long period of time.

### Initial Movement Downhill or Uphill

- If the gear is shifted and brakes are released while the engine is operated
- If the gear is shifted to D or DM and the vehicle is downhill, transmission closes the clutch slowly and vehicle starts to move slowly.
- If the gear is shifted to R or RM and the vehicle is uphill, transmission closes the clutch slowly and vehicle starts to move backwards slowly.

### Driving

#### Automatic Driving Mode

Automatic transmission detects the road and load conditions and calculates and selects the appropriate gear according to the driver's pressing on the accelerator. When you think that the automatic transmission does not select

the appropriate gear, you may upshift or downshift by pushing / pulling the gear lever in the + / - direction.

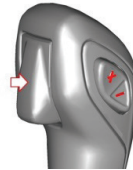

M shall be displayed on the screen temporarily if the gear is upshifted or downshifted with the gear lever. After some time, transmission shall return to automatic mode again, and D shall be displayed on the screen.

On automatic drive mode (D), the transmission adjusts the shifting speed according to the pressing level on the accelerator. Shifts gear at low speeds for economy when the accelerator is pressed lightly, and shifts gear at high speeds for performance when the accelerator is pressed strongly

When the accelerator is pressed fully, it finds another level that can be sensed with the foot, too. If you press beyond this

level, transmission downshifts for higher power and allows the engine to reach a higher speed. This feature, called as “kick-down”, helps the vehicle to accelerate while overtaking another vehicle or when power is required.



### Using in Creep Mode

Crawler mode allows the vehicle to automatically take-off slowly and move in idle without pressing the accelerator pedal.

Crawler mode may operate at each gear allowed for take-off, unless the clutch is overloaded due to the vehicle load and the inclination of the road.

You may change the gear manually before the vehicle starts to move, and thus you may set the idle movement speed as per the speed of the traffic.

When the crawler mode is set to on, it is activated after the initial take-off only.

# OPERATION

## Shifting



### CAUTION

DM and RM modes shall only be used for coasting, and only as it is required.



### CAUTION

DM and RM modes are not 'boosts.'

The duration of DM and RM modes is limited by the transmission control unit. Manoeuvre mode (DM and RM) puts a strain on the clutch lining when it is used for a long

time, then **CL** warning is displayed on the display; shift the transmission to neutral and wait for a while.

### STOP

Transmission is faulty. Stop the vehicle and contact a Ford authorized dealership.

### SERVICE

Transmission is faulty. Take the vehicle to a Ford Trucks authorized dealership in the shortest possible time.

### Manual Use:

- Take-off gear is automatically determined.
- Clutch movement and shifting operation is automatic when the gear is shifted manually with the shift lever.
- False shifting is not possible.
- Manoeuvre operation is available in automatic mode only.

If the vehicle is driven in manoeuvre mode despite the **CL** warning on the display, transmission shifts to gear automatically. In this case, vehicle may be accelerated.



### CAUTION

Do not to exceed the maximum engine speeds allowed during manual operation.

### Display warnings:

Transmission warnings are displayed as 2 digit abbreviations on trip computer.



System Check: System checks itself whenever the ignition is switched on.



Forward Manoeuvring Mode. This shall be used while coasting only.



Neutral Gear



shift to neutral.

**R2** Reverse, high range

**R1** Reverse, low range

**RM** Reverse Manoeuvring Mode. This shall be used while coasting only.

**AL** Air pressure low: If the air pressure in the transmission air line goes below 5.8 bar, AL warning shall be displayed.



### WARNING

- Attempting to shift while the air pressure is low may cause shifting of the transmission to neutral. In this case, exhaust brake shall not be active.
- When the air pressure drops, it is not possible to disengage the clutch.

**CL** Clutch is overloaded.

This is displayed when you attempt to take off the vehicle with a gear higher than required in manual mode. Select a lower gear and take off the vehicle in this condition.

**CW** Clutch lining wear  
Clutch lining wear has reached limit value. Please visit a Ford Trucks authorized dealership in the shortest possible time.

**FP** Accelerator Pedal:  
Remove your foot from the accelerator when this warning is displayed. If the warning is not removed, there is a fault in the system. Please visit a Ford Trucks authorized dealership.

**HT**  
Transmission oil temperature has reached upper limit. Stop the vehicle. Please contact a Ford Trucks authorized dealership.

# OPERATION

## Shifting

### High speed drive mode

Tractor and Road series vehicles may some times require to operate at high speeds continuously.

When high speed and power are required, you may turn on the power mode of the transmission, and allow the transmission to shift quicker at higher speeds.

To activate the power mode, press the power rocking switch on the front panel once. Press on the switch again when you want to deactivate it.

PWR flashes on the information display when the power mode is active.

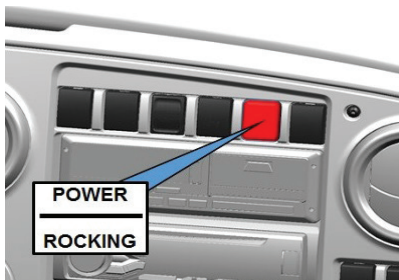

### Off-road driving mode

Construction series vehicles may require to operate at high speeds continuously on off-road conditions and to prevent unnecessary shifting.

On off-road conditions where unnecessary shifting shall be prevented, or where quick shifting or operating at high speeds are required, you may turn on the off-road mode of the transmission and ensure that transmission shifts as per the soft ground and rough terrain conditions.

To activate the power mode, press the off-road/Rocking switch on the front panel once. Press on the switch again when you want to deactivate it.

OFR flashes on the information display when the off-road mode is active

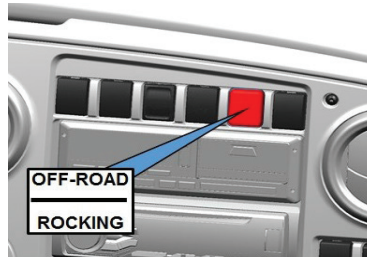

### Oscillation mode

All vehicles with automatic transmissions feature an oscillation function that oscillates the vehicle to recover it when the drive wheels are stuck on soft ground. To activate the oscillation mode, press the off- road/Rocking switch on the front panel for 3 seconds. Press on the switch again for 3 seconds when you want to deactivate it. ROC flashes on the information display when the oscillation function is active.

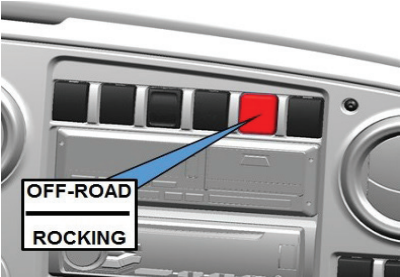

Differential locks are also activated automatically when the oscillation function is activated.

To oscillate the vehicle after activating the oscillation function, press on the accelerator and release it quickly and allow the vehicle to oscillate forwards and backwards.



# OPERATION

## Power take off

### Power Take Off

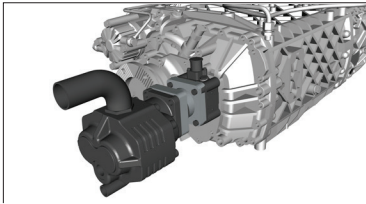

Illustration is for informational purposes only. There are no adaptors or pumps on the vehicle.

PTO is the unit connected to the transmission to operate the equipment that will be operated by taking power from the transmission (such as pumps). It transmits the power it takes from the transmission to the pump.

PTO installation is optional and can be performed on both manual and automated transmissions during production in the factory. Contact a Ford Trucks authorized dealership for the retrospective PTO installations.

Engine electronic control unit on your Ford Trucks vehicles allows that the engine is operated at a constant speed when PTO is activated. Speed parameter on the control unit may be set by the Ford Trucks authorized dealers.

### PTO on Vehicles with Manual Transmission





Operating speed can be 2 different speeds according to the half gear latch on the shift lever. Set the half gear latch up or down before activating PTO. Do not tamper with the latch while PTO is operated.

Pump shall operate with higher speed when the latch is up, and with lower speed when the latch is down.

#### Activating the PTO

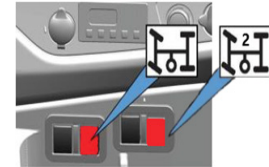
- Stop the vehicle and apply the parking brake.
- Shift to neutral, set the engine to idle. Depress the clutch pedal and hold it pressed.



- 10 seconds later, press the  switch on the center console. Yellow light on the switch shall be illuminated.
- Take your foot off the clutch pedal.

#### Deactivating the PTO

- Fully depress the clutch pedal for 10 seconds without taking your foot off (on vehicles with clutch pedal)
- Press the  switch on the center console, yellow light shall be turned off.
- Take your foot off the clutch pedal (on vehicles with clutch pedal).

#### PTO on Vehicles with Automated Transmission

- PTO can only be activated when the vehicle is stationary and rotating knob is at position "N". PTO is activated by pressing the PTO on the console.
- Shifting is not possible when PTO is activated and vehicle is moving.
- PTO cannot be activated when the vehicle is moving.

When the PTO is activated, the relevant

 symbol in the functions section will light up on the display.

In vehicles with dual output PTO, the 1st and 2nd output of the PTO can be activated separately by using the buttons shown in the image on the left and the above activation procedure.

### PTO valve switch

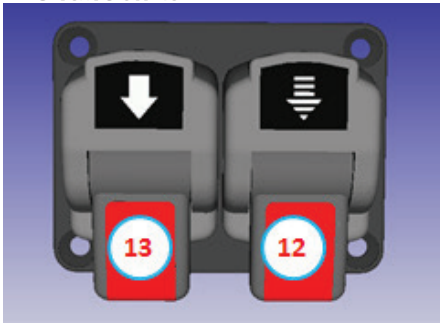

Control unit is used for lowering the bed in dump trucks. Button #12 is used for slow lowering, button #13 is used for fast lowering operation. Use the 'PTO (power take-off)' button in the panel to raise the bed.

# OPERATION

## While driving

4



### WARNING

The driving, braking and manoeuvring behaviour of the vehicle varies according to the type, weight of the load, and the location of the center of gravity.

Make sure that the vehicle is loaded in balance and avoid an unbalanced weight distribution.

Secure the load to prevent sliding when required. Otherwise, you may lose the control of the vehicle and cause an accident.



### CAUTION

Observe the allowed axle loads, wheel loads (half of the axle load) and maximum total weight of the vehicle. Otherwise, damage to the tires, chassis and axles may occur. Otherwise, damage to the tires, chassis and axles may occur. Observe the indicators on the instrument panel while driving.



### WARNING

Make sure that the driven wheels are held on the road while driving, and especially on the off-road.

Prevent the spinning of the driven wheels (Differential damages).

Activate the differential lock.



### CAUTION

Driving too much off-road may cause damage to the vehicle. The obstacles may not be noticed in time and the structure of the ground may not be assessed properly.

E.g. deep tracks formed before may damage

- Axles
- Driveshafts
- Fuel tanks
- Compressed air reservoir
- Engine
- Transmission May damage it.

Therefore, always drive slowly off-road. If you need to drive over the obstacles, the co-driver should provide directions.

Always observe the height of the vehicle from the ground. Avoid obstacles whenever possible.



### WARNING

In vehicles with engine driven power output (Engine-PTO), Trucks Concrete Mixer series in particular, the angle of the shaft mounted at this point by the superstructure manufacturer with respect to the engine shall not exceed the value of 3°. Make sure that the superstructure of your vehicle was constructed accordingly. Otherwise, it may result in vibration, balance and thus serious engine and superstructure problems.



### CAUTION

You may not observe the obstacles in time or assess the structure of the ground properly. Always drive slowly off-road to prevent damage to the vehicle. The vehicle may slip sideways or turn over. Never drive the vehicle in a direct angle to the slope, always drive in parallel to the slope. Do not manoeuvre in the opposite direction.

If your vehicle cannot take a slope, drive in the reverse gear.

You may lose the control of the vehicle when you shift to neutral or press the clutch or try to brake the vehicle with the service brake only in slopes. Do not let your vehicle move in neutral or with the clutch activated.



# OPERATION

## While driving

If you load your vehicle excessively, this would increase the risk of turning over. Do not exceed the maximum permissible axle load. Maintain the center of gravity as low as possible when you are loading your vehicle. Materials that lower that the effect of braking, such as sand or water mixed with oil, may enter the brakes if you drive your vehicle on muddy or swampy areas frequently. This may cause excessive wear and a decrease in the braking effect. A risk of not being able to use the braking effect fully in emergency conditions is present.

Test the brakes after any off-road drives. If the braking effect is lowered or that rubbing noises are present in this test, make sure that your brake system is checked by a FORD OTOSAN authorized dealership.



### WARNING

Acceleration forces act on your body from all directions due to the improper nature of the ground. There is a risk of bouncing off the seat and injuring yourself. Always fasten your safety belt in the off-road drives, too. Drive systems for off-road driving Driving systems and equipment described below

allows you to drive your vehicle safely off-road:

- Disengagement of the ASR.
- Differential locks.



### WARNING

The steering wheel may strike back and cause injuries on the thumbs of your hands when driving over obstacles or the tracks formed over the road. Hold the steering wheel tightly with your both hands.

Consider the high forces occurring for a short period of time while driving over the obstacles.

- Stop the vehicle and engage a lower gear before driving off-road.
- Always drive the vehicle with the engine running and a gear engaged while driving off-road.
- Drive slowly and with a stable speed. Drive with the crawling speed if required.
- Make sure that the wheels are always held on the road.
- Activate the differential lock.
- Drive with extra care in an unknown or a non-visible area. Get off the vehicle first, and inspect the terrain for safety reasons.
- Check the depth of the water before

driving through the water.

- Observe the obstacles like rocks, holes, trunks and trenches.
- Avoid skirts of the ground that the ground may be torn.

### Before driving off-road

- Engagement of the differential lock
- Disengagement of the anti-skid control
- Equipment specified below should be available on the vehicle:
  - Shovel
  - Climbing hawser with bolted Y anchor .

### After driving off-road



### WARNING

Faults caused by off-road driving may cause accidents or prevent some parts from operating.

Clean and check your vehicle after driving off-road. Have the fault repaired before next operation of the vehicle.

- Disengage the differential lock
- Engage the anti-skid control (ASR)
- Clean the vehicle
- Check the vehicle for any damage.

# OPERATION

## While driving

### Fuel consumption

Fuel consumption depends on the conditions below:

- Model of the vehicle
- Driving style
- Operating conditions
- Tire dimensions, tire profile, tire pressure, condition of the tires
- Upper structure, air deflector
- Drive train for the drive applications
- Auxiliary applications (A/C and heater, auxiliary power outlet, viscous fan)

Fuel consumption information may be displayed on the standard on-board computer.

### Driving style

To lower the fuel consumption:

- Avoid frequent acceleration and braking
- Drive carefully by paying attention on the road
- Drive within the economic engine speed limits

### Workstations

Fuel consumption depends on the conditions below:

- Highland conditions
- Traffic in cities and short distances
- Vehicle load
- Operation while the vehicle is parked
- Frequent starting when the engine is cold

Thus, it is not possible to provide a certain value for the fuel consumption of the vehicle.

# OPERATION

## ECAS ( Electronically Controlled Air Suspension )

### Manual Control Unit ( In Vehicles with Air Suspension )



Chassis height of the vehicles with 4 air bellows on rear axle may be adjusted by the control.

ECAS control is placed on the left of the driver's seat over the fender.



**WARNING**

Do not change the chassis height of your vehicle by the manual control unit when driving. Use the manual control unit when your vehicle is stationary and parking brake is applied.

This is important for the safety of you and your vehicle.

### Using Manual Control Unit ( Only In Vehicles with Air Suspension )

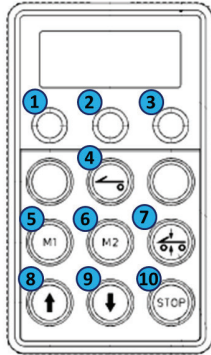

- 1- N/A
- 2- Rear axle activation light
- 3- N/A
- 4- Driven axle selection button
- 5- M1 Memory button
- 6- M2 Memory button
- 7- Normal drive height button
- 8- Lifting button
- 9- Lowering button
- 10- Stopping button

1. Ignition switch should be in position 2 to activate the air control system by the "manual control unit".
2. Functions desired can be performed after pressing the 4 driven axle selection button.
3. Press the "STOP" button if you need to stop the operation during any procedure.
4. If you want to record a certain chassis height, press the "STOP+M1 or M2" buttons for 2 seconds at the same time. This would record the height to the system. In the future, when you want to adjust the vehicle to this height, press M1 or M2 button after you press the "front selection - rear axle" button.

NOTE:  marked buttons are not active.

 Symbol is illuminated on the instrument when the vehicle is not at driving height

# OPERATION

## ECAS (Electronically Controlled Air Suspension)

### Manual Control Unit (In Vehicles with 6 x 2 Air Suspension)



Chassis height of the vehicles with 6x2 air suspension may be adjusted. ECAS control is placed on the left of the driver's seat.

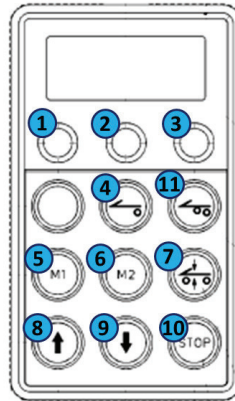

- 1- N/A- This button is not active.
- 2- Rear axle activation light
- 3- N/A- This button is not active.
- 4- Driven axle selection button
- 5- M1 Memory button
- 6- M2 Memory button
- 7- Normal drive height button
- 8- Lifting button
- 9- Lowering button
- 10- Stopping button
- 11- Lifted axle selection button

1. Ignition switch should be in position 2 to activate the air control system by the "manual control unit". work has been performed.
2. Functions desired can be performed after pressing the 4 driven axle selection button or 11 lifted axle selection button.
3. Press the "STOP" button if you need to stop the operation during any procedure.
4. If you want to record a certain chassis height, press the "STOP+M1 or M2" buttons for 2 seconds at the same time. This would record the height to the system. In the future, when you want to adjust the vehicle to this height, press M1 or M2 button after you press the "front selection - rear axle" button.

In the future, when you want to adjust the vehicle to this height, press M1 or M2 button after you press the "front selection - rear axle" button.



### WARNING

Do not tamper with the rear suspension load detection sensor connections of your vehicle and do not have ECAS values changed.

## ECAS (Electronically Controlled Air Suspension)

### Front Axle Height Adjustment Mechanism

Front axle lifting system shall be deactivated when the ignition is switched off and vehicle shall be lowered to drive level. In this case, use care for the relationship of the parts of the vehicle approaching the ground with the surroundings.

Front axle lifting system shall be deactivated when 30 km/h speed is exceeded and the vehicle shall automatically be adjusted to driving height



### Operating Instructions for Front Axle Height Adjustment Mechanism (Only for Vehicles that the height of the 5th wheel is lowered)

Ignition switch should be in position 2 to activate the air control system by the "Lifting Switch".

When the front axle lifting switch  is pressed, front suspension bellows start to raise the front chassis of the vehicle. While the system is active, on vehicles with Manual transmission: An audible warning signal with a gong sound is heard.

On vehicles with an automatic transmission:

An audible warning signal with a gong sound is heard and  symbol is displayed on the indicators.

When the rear axle lowered drive level control button  is pressed,  symbol is displayed on the indicator. This allows lowering of 5th wheel level by lowering the rear axle that is taken to drive level in ECAS manual control.

# OPERATION

## Air Suspension Mechanical Level Adjustment

### 32XX S Self Steering In Vehicles with Air Suspension

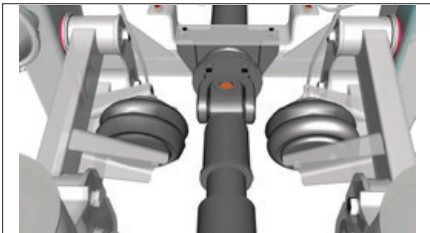

In 32XXS four axle vehicles the second axle is self-steered and has an air suspension. This axle facilitates vehicle's manoeuvring by complying with the turn of the front axle in forward and backward manoeuvres.

When the vehicle is shifted to reverse, the caster mechanism allows the axle to perform a backward manoeuvre by automatically adjusting the axle's caster angle. Additionally, the self-steered axle can be lifted by a control switch in the cab.



#### CAUTION

In reverse manoeuvres you should wait 8 to 10 seconds after the forward manoeuvre to allow the wheels turn in the opposite direction.



#### CAUTION

Do not perform a reverse manoeuvre when the gear is in neutral.

# OPERATION

## Tag Axles

### System description

Axle raising feature in 6x2, 8x2C and 8x2S Series trucks with mechanical suspension is controlled by the equipped AutoDrop (Automatic Axle Lowering) System. Axle positions are checked by the system in terms of vehicle safety and performance in case of driving conditions of your vehicle such as ignition on, park brake, vehicle speed conditions.

### Pressing the Button While Axle is Lowered

If the system allows, relevant axle is raised, icon is displayed on the Function menu of the instrument panel and the light on the button is illuminated.



If the system does not allow, relevant axle is not raised, warning message is displayed on the Information panel and the light on the button is not illuminated.

Not allowed conditions:

### Park Brake

In order to improve the performance of park brake, system lowers the tag axle if it is raised or does not allow it to be raised if it is already on the ground while the park brake is active. A warning message shall be displayed on the instrument panel in this case.



This applies to tag axle only, it does not apply to self-steered axle.

Air pressure available in the vehicle shall be over 6 Bars in order to release the park brake.



### Vehicle Speed

Axle raising functions are cancelled for safety reasons if the vehicle speed is over 30 km/h. Axle raised is lowered again for traction assist. In this case, when the button is pressed to raise the axle, the axle positions do not change and a warning message is displayed on the instrument panel.



### Axle Weights

When the vehicle is loaded over the limits allowed for axles loads, axle(s) which have been raised before are automatically lowered or if they are lowered, they are not allowed to be raised.

System calculates the weights per axles as per the information taken from the sensors connected to the vehicle. Therefore, weight limits specified for each axle are controlled.

# OPERATION

## Tag Axles

Therefore, you should avoid unstable loading of the truck in order to use the axle raising system better and to obtain a better efficiency.



### System Error

System has the feature to detect any faults that may occur in electronic components such as axle raising valves. In such a case, a warning message and the  symbol are displayed, and the axles are brought to ground position for safe driving. Take your vehicle to an authorized workshop to have the fault repaired in such a case.

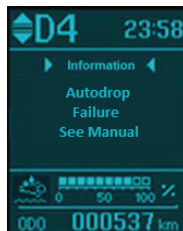

### Pressing the Button While Axle is Raised

If the system allows, relevant axle is lowered, icon disappears from the Function menu of the instrument panel and the light on the button is turned off. If the system does not allow, relevant axle is not lowered, warning message is displayed on the Information menu of the instrument panel and the light on the button is not turned off. Not allowed conditions:

### Vehicle Speed

Axle lowering functions are cancelled for safety reasons if the vehicle speed is over 30 km/h. In this case, when the button is pressed to lower/raise the axle, the axle positions do not change and a warning message is displayed on the instrument panel.

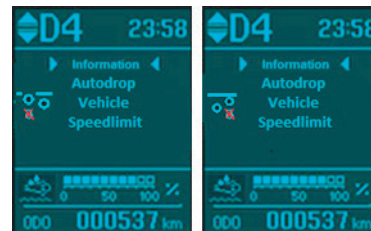

### Unloaded Vehicle Condition (For 8x2S only)

In 8x2S vehicles, is automatically raised and not allowed to be lowered again in unloaded vehicle condition - until live and tag axles have been loaded up to 12 ton approximately in total - in order to improve the handling, braking and life-cycle performance of the self-steered axle. A warning message shall be displayed on the Information Menu in this case.

### Axle Weights

When the vehicle is loaded over the limits allowed for axles' loads, axle(s) which have been raised before are automatically lowered according to the loading amount and a warning message is displayed on the Information Menu.



# OPERATION

## Tag Axles

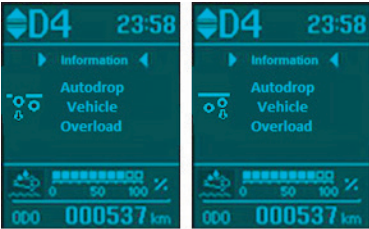

 **WARNING**

Axle load limits are increased 30% up to a speed of 30 km/h to obtain a better traction during take-off. After a speed of 30 km/h, limits return to original values, so the system may activate and lower the axles!

 **WARNING**

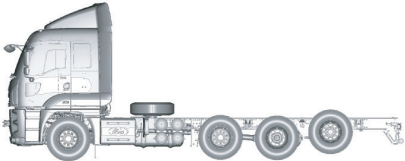

As shown in the figure, the tag axle shall not raised when the self-steered axle is on the ground, or the self-steered axle shall not lowered when the tag axle is raised.

To control these situations, system rejects the relevant requests and a warning message is displayed on the Information Menu.



### Sensor positions and maintenance

System includes displacement sensors in order to send vehicle weight information to the Electronic Brake System (EBS). Positions of the sensors used for calculating the axle weights on the vehicle are shown in the figure. There are 4 sensors in total on the vehicle, these are 1 for each of right and left chassis arm on the tag axle, 1 for live axle crossmember connection and 1 for front axle right chassis arm.

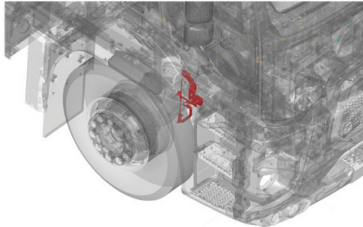
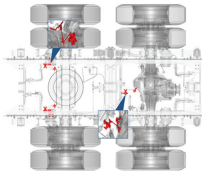

 **WARNING**

Sensors are calibrated during production, do not tamper with sensor connections to ensure safe driving. Remember that brake system shall also be affected in this case. We recommend you to visually inspect the mechanical connections of the sensors in weekly intervals.





 **WARNING**

Never raise the tag axle when the vehicle is loaded.

# OPERATION

## Tag Axles



### Steering Additional Axle Indicator Interface and Control Panel

The status of the steering axle can be monitored during the steering additional manoeuvre via the trip computer functions screen and the information menu. When it is thought that the additional axle tires may be damaged by dragging against the pavement or an obstacle during the parking manoeuvre, the “additional axle centring” (  ) button on the control panel should be pressed in order to centre the additional axle. When the “additional axle centring” button is pressed,  symbol will appear on the functions screen. After the vehicle has moved, the risk for the additional axle tires is eliminated. When the “additional axle centring” (  ) button is pressed again, the steering function will be activated and  will appear on the information screen.



### Steering Additional Axles Warnings

A warning will be given on the information display for possible malfunctions of steering axle system. When the "rotatable rear axle is overheated" warning appears, a yellow  symbol will appear. The warning will disappear when the system is expected to cool down without stopping the vehicle and making a steering action.

When the warning “Temporarily disabled” comes up, a yellow  symbol will appear. In this case, there is a possibility that the warning will disappear at the next contact engaging. If the yellow  symbol and “Temporarily disabled.” warning continues, the vehicle should be taken to the service.

When the warning “Rotatable rear axle has failed. Go to the service.” Comes up, a red  symbol will appear.

In this case, service intervention is required to rectify the fault.





### CAUTION

ESP is an auxiliary brake system. Always remember that no system can change the physical laws. Driving safety is responsibility of the driver despite all auxiliary systems.

**EBS** (Electronic Brake System)  
EBS (Electronic Brake Control) is an integrated braking system that includes sub-systems.

#### 1- Braking power control:

EBS control unit adjusts the braking power on the wheels automatically based on the information from the load sensor and the brake pedal travel applied by the driver.

#### 2- Automatic braking power distribution between axles:

EBS adjusts the braking power that will be applied to the axles based on the axle load.

#### 3- ABS:

ABS maintains steering control by preventing the locking of wheels during brakes.

#### 4- Automatic Traction Control:

Main purpose of this function is to prevent skidding of driven axle wheels.

a) Braking power control: The speeds of the wheels of the driven axle are equalized by decelerating the skidding wheel by braking.

b) engine torque is automatically limited to ensure that the vehicle moves stably.

#### 5- Inertia torque control:

Wheels may skid due to the engine inertia in slippery surfaces. Especially, when the transmission is downshifted and/or retarder is activated, wheels may have an inclination to skid. Inertia torque control system sends a signal to engine control unit and adjusts the engine torque to overcome the inertia of the engine.



### CAUTION

Retarder may cause the vehicle to skid in slippery road conditions.

#### 6- Emergency brake assist system:

System senses the braking operation and increases braking power according to the pedal travel.



### CAUTION

Emergency brake assist cannot increase the maximum capacity of braking power. Vehicle shall be braked in the limits of maximum braking power.

#### 7- Tilt prevention system:

System senses the risk of tilting automatically when the brake is applied and decreases the braking power of front wheels and increases the braking power of rear axle. Thus, vehicle is prevented from tilting.

# OPERATION

## EBS - ESP

### ASR Deactivation Mode:

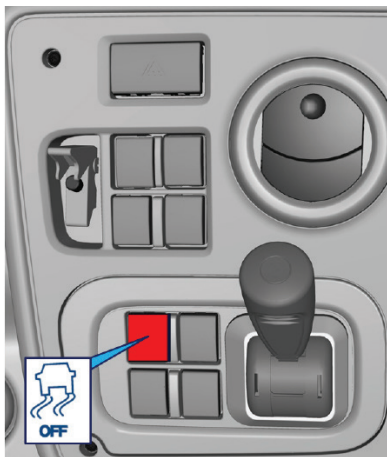

You may want to disable ESP on soft road conditions. In this case, press the ESP cancel switch located in the centre console.

 light is illuminated on the display when this mode is active.

# OPERATION

## Differential Lock

### What is differential lock?



Differential lock is a system that increases the capacity of transmission of power to the surface. Lock gear consists of the yoke that moves the gear and an air operated piston. Engine torque transmitted to the left and right sides of the vehicle and wheel speeds are equalized when the differential lock is engaged. Activate the differential lock in bad and slippery road conditions where high and stable traction power is required.



### Engagement of the differential lock

1) Activate the differential lock before running into worsening road conditions. Ensure that the road is not slippery and any wheel is not skidding or slipping. Ensure that the wheels are not on slippery surface and stop the vehicle completely. Engage the differential lock button(s) in the instrument cluster. 4x2, 6x2 and 8x2 vehicles have optional one differential lock; 6x4 and 8x4 vehicles have front differential locks (FDL), rear differential locks (RDL) and inter-axle differential locks (IADL) as standard.

On X2 vehicles,  light will be illuminated on the instrument panel when differential lock is engaged, and a warning buzzer shall sound if available.

On X4 vehicles both  FDL light and  RDL light will be illuminated when differential lock is engaged and a warning buzzer shall sound if available.



### CAUTION

If the differential lock is not used properly, there is a risk of heavy damage to the differential unit and/or a serious risk of accident. Differential faults caused by using improper use of differential lock are out of warranty cover

# OPERATION

## Differential Lock

4

### The points to be considered when the differential lock is activated:

If required, the differential lock shall be engaged prior to go through the rough surface at the required distance and its engagement and disengagement shall be monitored via the illuminated warning sign on the instrument cluster.

Vehicle may move outward of the curve in turns while the DCDL is completely activated. Do not use differential lock on paved roads, and never perform turns when the locks are engaged.

When turning, make sure the differential lock is disengaged. Otherwise the differential of your vehicle may be damaged severely and you may have to call for AAA.

The maximum speed shall be 20 km/h when differential lock is engaged.

### Deactivating the differential lock:

1. When it is safer to drive above certain speeds as soon as road conditions become normal, differential lock must be deactivated. Vehicle shall be stopped and differential lock shall be disengaged after making sure that the vehicle moved far away from the slippery surface. Ensure that the wheels are not on slippery surface first and stop the vehicle completely.
2. Deactivation of the differential lock is performed when the warning light on the instrument panel is turned off and this may take about 500 meters sometimes. Turn the differential lock switch(es) on. Drive the vehicle very slowly by applying the accelerator slowly to deactivate the differential lock.
3. The differential lock will disengage once the illuminated warning sign on the instrument cluster and the warning buzzer, if any, will stop.
4. You can continue driving observing the legal speed limits according to flow of the traffic.



### CAUTION

Vehicle should always be decelerated in sharp curves, and it is advised that the differential lock is deactivated in sharp curves. User is informed by buzzer on that differential lock is activated.



### CAUTION

Deactivate the differential lock when driving the tractor vehicles down the slopes. Trailer may be folded due to the loss of the vehicle dynamics.

### Usage of the driver controlled inter-axle differential lock (IADL):



Ford-Otosan Inter-Axle Differential Lock (IADL) is driver controlled system operated by the pressurized air; it allows that the traction torque is distributed evenly to the front and rear axles and ensures that the axles speeds are equal.

It is available on 6x4 and 8x4 models only. IADL button is on the centre instrument cluster. It is also known as "Inter-differential power distributor" or "3rd differential".



### WARNING

IADL shall be disengaged in standard road conditions i.e. when the tyres are not slipping. Activate all differential locks to evenly distribute the traction to the front and rear axles in slippery and snowy road conditions. Deactivate the IADL when the vehicle is returned to normal road conditions.

# OPERATION

## Lane Departure Warning System

### WARNING

 LDWS is only a warning system and does not interfere with dynamics of the vehicle. Always drive attentively and do not try to test the system on the road.

 LDWS will not warn if emergency lights are active

 LDWS will not warn if LDWS warning lamp is constantly on, meaning that system is not active due to driver deactivation or an error.

 In order not to get lane departure warnings for the intended lane changes, always operate turn signal to the direction of lane change.

 The system does not relieve you of your responsibility to drive with due care and attention.

 At all times driver is responsible for controlling your vehicle, supervising the system and intervening if required.

 The sensor may incorrectly track lane markings such as other structures or objects. This can result in a false or missed warning.

 In cold and severe weather conditions the system may not function. Rain, snow, spray, worn or dirty lane markings and large contrasts in lighting can all influence the sensor.

 The system may not operate in areas during roadwork construction.

 The system may not operate on roads with sharp bends or narrow lanes.

 Do not carry out windshield repairs in the immediate area surrounding the sensor.

 The system may be impaired or may not operate properly if:

- Visible lane markings are not continuous
- There is glare due to oncoming traffic, direct sunlight or reflections or from wet surfaces
- Front camera visibility is low due to insufficient road illumination or due to snow, rain, fog or heavy spray

- Lane markings are not detected due to vehicles driving in front
- The part of the windscreen where front camera is located is dirty, misted up, damaged or covered
- No lane markings or several ambiguous lane markings are present, i.e. lanes branch off, cross or merge

**Note:** The system may assist you when driving on fast main roads and freeways.

**Note:** The system may operate with a minimum of one tracked lane marking.

**Note:** The system may only operate above vehicle speeds of approximately 60km/h.

### Principle of operation

Lane Departure Warning System sensor is located behind lower part of the windscreen. It continuously monitors conditions to alert the driver of unintentional lane drifting at high speeds. Once vehicle speed is above 60kph, if there are visible lane markings on each side of the road, lane markings may appear on the LDWS page of the cluster display showing that system is active and ready to warn.



## Lane Departure Warning System

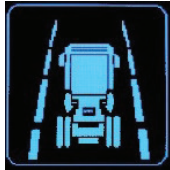

LDWS icon on cluster display

Warnings consist of audible and visual warnings with spatial indication about the direction of unintended drift of the vehicle. In order to make the warning more audible, system mutes radio and stops the blowers of air conditioning system until the end of the warning.

- If unintended lane departure is detected from left lane marking, LDWS page, shown in the figure above, will pop-up with a blinking left lane marking, a blinking LDWS warning lamp and an intermittent warning sound coming from left hand side will be activated.
- If unintended lane departure is detected from right lane marking, LDWS icon shown above will pop-up with a blinking right lane marking, a blinking LDWS warning lamp and an intermittent warning sound coming from right hand side will be activated.

Once LDWS has issued a warning, further warnings will only be issued when the

vehicle is once again fully within the lane markings.

### Switching the System On and Off

When the ignition is turned ON, LDWS will be automatically active unless there is no error.

To switch off, press the LDWS button .

Then, LDWS warning lamp  will light up constantly on the instrument cluster.

To switch the system back on, press the LDWS button once again and visually verify that LDWS warning lamp  on the instrument cluster turns off.

The system is configured to warn on unintended lane departures only. Driver's awareness of the situation is monitored via driver inputs listed below. If these driver inputs explicitly show that there is an attentive driver, lane departure warnings are suppressed.

- Rate of lane departure, i.e. how fast is the lane being departed
- Brake pedal usage
- Steering wheel turning rate, i.e. how fast the steering wheel is turned
- Direction indicator activation for the side lane being departed

Note: If the left / right turn signals are active for a minute longer, these signals will not prevent the system from giving a warning



LDWS on/off switch

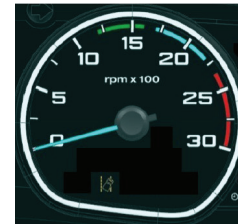

**Note:** In case camera vision is obstructed, driver may get below message on the cluster display.

Front Camera  
Low Visibility  
Clean Screen

**Note:** The message above is a clear indication that the sensor view is obstructed in a way that LDWS operation is negatively affected.

# OPERATION

## Lane Departure Warning System

**Note:** LDWS may get deactivated due to blockage, illuminating the LDWS warning lamp  constantly.

When the message above is seen on the cluster display:

- In case camera vision is obstructed due to heavy rain or snow, try to activate wipers at a correct speed or activate Auto-Wipe feature to enhance LDWS performance.
- In case windscreen is dirty, activate the washer to remove the dirt.
- In case windscreen is misted up, turn on the defrosters to remove the mist on the windscreen.

**Note:** If the information message below appears on the cluster display, this means LDWS needs to be inspected by an authorized Ford Trucks Service, and LDWS will not be available till the inspection.

**Front Camera  
Malfunction  
Service Required**

**Note:** If LDWS warning lamp  gets constantly illuminated and stays illuminated for a long time, there may be an error in the system, causing deactivation.

4

## Emergency braking system

### Advanced Emergency Braking System

#### Principle of operation

If your vehicle is rapidly approaching another stationary vehicle or a vehicle traveling in the same direction as yours, and if the Advanced Emergency Braking System (AEBS) detects that a rear end collision situation gets imminent with a motor vehicle ahead, the system is designed to provide two levels of functionality:

1. Collision warning
2. Emergency braking

**Collision Warning:** If the system determines that a collision is imminent, AEBS warning lamp flashes, an intermittent warning tone sounds, and a warning message pops-up in the information display.

In order to make the warning more audible, system mutes radio and stops the blowers of air conditioning system until the end of the warning.

If the system detects that you still do not take control of your vehicle to avoid the accident and collision is still found to be imminent, AEBS may apply partial braking along with acoustical and optical warnings to further draw your attention.

**Emergency Braking:** If the collision is still found to be imminent, the system may apply full braking to reduce the impact damage or avoid the crash completely.

**Note:** AEBS is not active if you are driving below 15kph.

**Note:** AEBS will not warn or brake if the relative speed between your vehicle and the lead vehicle is below 10kph.

**Note:** Deactivation of the ESP feature via the ESP switch will deactivate the AEBS as well.



#### WARNING

**Note:** If the AEBS warning lamp is constantly ON, this means either system is deactivated by the driver, or AEBS shut off due to an error. In this case, AEBS is OFF. The system will not warn or intervene.



#### WARNING

**⚠** If you receive an AEBS warning, which means a rear-end collision is imminent, always apply brakes yourself to avoid the accident and try to take evasive action. Failure to take care may result in the loss of control of your vehicle, serious personal injury or death.



AEBS visual warning on cluster display

**⚠** AEB System is a collision avoidance system. However, AEB System is not a substitute for safe and attentive driving. AEB system has its own limitations for certain traffic scenarios. Note that AEB system might not work in all conditions as expected. The system does not relieve you of your responsibility to drive with due care and attention. Failure to take care may result in the loss of control of your vehicle, serious personal injury or death.

**⚠** AEBS is not able to guess other drivers' intentions. Always maintain a safe distance with the vehicle in front of you. Failure to take care may result in the loss of control of your vehicle, serious personal injury or death.

# OPERATION

## Emergency braking system

4

 AEB system is designed to provide active driver assistance to avoid rear-end collisions or mitigate the effects of a possible collision in real traffic situations in certain frontal collisions only.

 AEB System may not always recognize a collision situation and/or may not be able to avoid an accident. AEBS is neither designed to recognize complex traffic situations, nor to avoid all kinds of accidents. It is your responsibility to drive carefully at all times. Always pay careful attention to the traffic situation and be ready to brake. Failure to take care may result in the loss of control of your vehicle, serious personal injury or death.

 The system does not react to cyclists, motorcyclists, pedestrians, animals or vehicles that are driving in a different direction. Failure to take care may result in the loss of control of your vehicle, serious personal injury or death.

 AEBS is not designed to avoid accidents against stationary vehicles. AEBS may only reduce the effect of a rear-end accident with stationary vehicles on certain conditions.

 The system may not operate when driving around sharp curves and wavy roads. Failure to take care may lead to a crash or personal injury. The system may or may not operate or may operate with reduced function during cold or severe weather conditions. Snow, ice, rain, spray and fog can influence the system. Keep the front camera and radar free of snow and ice. Failure to take care may result in the loss of control of your vehicle, serious personal injury or death.

 The system may not operate correctly if you replace the windshield with a non-Ford windshield. Do not carry out windshield repairs in front of the sensor. Failure to adhere to this warning may lead to an accident or injury.

 If something hits the front end of your vehicle or damage occurs, the radar sensing zone may change. This could cause missed or false vehicle detections. Contact an authorized dealer to have the radar checked for proper coverage and operation.

 The system may not detect objects with surfaces that absorb reflections. Failure to take care may result in the loss of control of your vehicle, serious personal

injury or death. System performance may reduce in situations where the camera's detection capability is limited. These situations include but are not limited to direct or low sunlight, vehicles at night without tail lights, narrow vehicles and unconventional vehicle types. Do not rely on this system to replace driver judgment and the need to maintain distance and speed.

 AEB System effectiveness depends on many factors, such as speed, driver input, incremental precipitation, lead vehicle behavior, your vehicle's state and road conditions

 AEBS may not work as expected if your vehicle is not inspected by Ford Trucks Service on regular maintenance checks.

 It is driver's responsibility to switch off the AEB system during being towed via AEBS deactivation switch. Otherwise, AEBS may warn and/or brake unexpectedly.

AEBS shall be turned off by the driver while driving off road.

## Emergency braking system

### How to maintain Advanced Emergency Braking System?

**Note:** If a message regarding a blocked radar sensor is shown in the information display, the radar signals are obstructed. The radar sensor is located behind a fascia cover integrated to the middle-bottom of the upper grille. With obstructed radar, the Advanced Emergency Braking System does not function and cannot detect a vehicle ahead.

Front Radar Sensor  
Blocked, See  
Manual.

Radar sensor blockage message

**Note:** It is driver's responsibility to keep the radar sensor behind the front grille clean. Make sure that cover of the radar sensor is free of mud, packed snow or any other foreign object.

**Note:** Do not mount any attachments in front of the radar sensor. Do not cover or paint the cover of the radar sensor. Any modification on the cover of the radar sensor could cause AEBS failure or reduced functionality.

**Note:** If something hits the front end of your vehicle or damage occurs, the radar sensing zone may change. This could cause missed or false vehicle detections. Contact an authorized dealer to have the radar checked for proper coverage and operation.

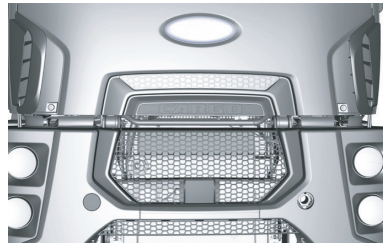

Radar location to be kept clean

**Note:** If a message regarding low camera visibility is seen in the information display, camera sensor view is obstructed. With the front camera obstructed, AEB System function may reduce or get deactivated. It is driver's responsibility to keep the windshield area clean where camera sensor is located to maintain full functionality. Make sure that there are no stickers or sun blocking films on the windshield blocking the field of view of

the camera. Have any windshield damage in the area of the camera's field of view repaired.

Front Camera Low  
Visibility Clean  
Screen

Camera sensor blockage message

### AEBS usage with trailers:

**WARNING**

**After connecting a new trailer to your vehicle, if ignition is already ON, you shall turn the ignition OFF and ON to get a fully functional AEBS.**

**⚠** AEBS will get deactivated if a trailer without ABS/EBS or with a faulty ABS/EBS is detected.

**⚠** AEBS usage is restricted to vehicle combinations with one trailer only. It is driver's responsibility to switch off the

**⚠** AEBS when more than one trailer is connected to the vehicle.

# OPERATION

## Emergency braking system

### Switching the System Off and On

**Note:** AEBS will be automatically ON everytime ignition is turned on, if there is no error detected by the system.

**Note:** To deactivate or activate the AEBS, press the AEBS switch on the dashboard shown in the figure below. When switched off, AEBS warning lamp on the instrument cluster will light up. To switch the AEBS on again, short press AEBS switch. In this case, AEBS warning lamp will turn off to show that AEBS is operational again.

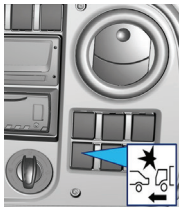

AEBS deactivation switch

### Why AEBS warning lamp may be constantly ON?

- You may have switched off the AEBS via AEBS switch.
- ESP may be switched OFF.
- If something hits the front end of your vehicle or damage occurs, the radar sensing zone may change. This could cause missed or false vehicle detections. Contact an authorized dealer to have the radar checked for proper coverage and operation. In such a case, AEBS malfunction may be displayed on the information display as shown below.
- If system emergency braking occurs two times in one ignition cycle, AEBS will get deactivated to prevent possible unnecessary interventions. In such a case, visit an authorized Ford Trucks Service to activate the system.

AEBS  
Malfunction  
Service Required

- There may be temporary or permanent errors on other components of the vehicle that cause the AEBS to be automatically deactivated. If the AEBS

warning lamp  stays illuminated constantly for a long time, visit an authorized Ford Trucks Service. This may mean that AEBS is deactivated due to an error in the system.

### How to override an AEBS intervention

 AEBS may warn and brake even if the traffic situation is not dangerous. Be prepared to suppress the AEBS.

You can suppress an AEBS warning or stop an ongoing AEBS warning, if you:

- use left/right turn signal
- depress the brake pedal
- depress the accelerator pedal
- press the AEBS deactivation switch

You can abort an AEBS triggered emergency braking intervention, if you:

- depress the accelerator pedal beyond the pressure point (kick down)
- press the AEBS deactivation switch

## Emergency braking system

If you are brought to a halt via an AEBS triggered emergency braking, AEBS will keep the brakes until you override by;

- depressing the accelerator pedal

or

- pressing the AEBS deactivation switch.



### WARNING

**Important Note:** In such a situation, take control of your vehicle and make sure that you activate the parking brake before leaving your vehicle. Take all necessary safety measures to secure yourself and your vehicle.

# USE

## Useful Information

4

### **CAUTION!**

**PLEASE HAVE IT CALIBRATED IN AN AUTHORIZED  
DEALERSHIP SPECIFIED IN THE TACHOGRAPH  
MANUAL PROVIDED**



- You have made an excellent choice by purchasing a Ford Trucks vehicle. Congratulations.
  - Please consider the following points and read this manual to obtain best performance and service life from your vehicle.
- 1. Air and oil filters**
- Replace the air filter element when air filter warning light is illuminated inside the cab. Always refer to the warranty and service manuals for the main filter element replacement intervals.
  - Use oil and air filters approved by Ford Otomotiv Sanayi only.
- 2. Adding oil**
- Do not add oil until the oil level is reduced to min.line.
  - Never add oil over the max.line.
  - Add oil to the engine when the oil level warning light is illuminated.
- 3. Engine**
- Your vehicle is equipped with a system that prevents starting of the engine while transmission is shifted to a gear.
  - Always observe starting instructions provided in the manual
- Do not increase the engine speed until oil pressure is increased after starting.
  - We advise you to operate your vehicle in the green zone tachometer to obtain best traction. (1050-1600 rpm)
  - Operate your engine at idle for 1 minutes before stopping the engine in order to allow continued lubrication of the turbocharger unit.
  - We advise you to use the vehicles with automated transmissions in automatic mode as much as possible.
- 4. Injector pump**
- Injector pump available in your vehicle is completely adjusted and sealed in factory.
  - Do not let tampering of injector pump by any other workshops other than authorized dealerships.
- 5. Wheel nuts**
- Have the wheel nuts tightened to the specified torque values after 500 km from the first loading point of your vehicle. This operation should be repeated after each nut removal. (750 +-50Nm)

# USE

## Useful Information

### 6. Wheel alignment

- Have the front alignment adjustment of your vehicle checked, and have it adjusted by service support if needed in the first 1000 to 5000 km.

### 7. Braking system

- Drain the water in the air tanks every day.

### 8. Differential lock

- Contact authorized dealership when the differential lock warning lamps is illuminated while the differential lock switch is not pressed.

The maximum speed shall be 20 km/h when differential lock is engaged.

### 9. Cab lift

- Ensure that park brake is applied, transmission is in neutral and hood is open before lifting the cab.

### 10. Upper bed

- Do not lower the upper bed while the vehicle is moving.

### 11. Refuelling

- Turn off the auxiliary cab heater before refilling fuel.

### 12. Tyre pressures

- Your vehicle is provided with low tire pressures from the factory. Adjust tire pressures according to the tire pressure values given in the manual before first loading.

## Useful Information

When your engine has been idling for a long time, smart engine off system warns you 30 seconds before turning off the engine and informs you about the fact that the engine is being turned off when a predefined time period has expired in idle with the smart engine off feature. All you need to do to prevent engine from being turned off is to press any of the clutch, brake or accelerator pedals within this period. Thus, you shall deactivate this feature until you restart the engine when you do not want your engine to be turned off.

Other conditions when this feature is automatically deactivated is as follows:

- When engine speed control applications (for example: PTO) are operated
- When the park brake is not applied
- When DPF regeneration is activated
- This feature would provide significant fuel saving and you shall enjoy the privilege of being a Ford Trucks owner.

You may increase or decrease the idling speed using speed control buttons when your vehicle is stationary. All you need to do is to bring the speed control handle to "resume" position and to activate this feature. After that, you shall simply decide at what speed the engine will run using "Set +" or "Set -" buttons.

You may also use this feature in PTO applications, too. Thus, you can set the engine speed to the optimum point in various load conditions and obtain the highest efficiency from the PTO. PTO applications are used in mixer vehicles, concrete pumps and in many other similar vehicles today. It is very easy to operate or turn off the engine or control the engine speed remotely by a remote control with a similar special applications in vehicles such as concrete pump. Thus, remote operation is possible without requiring the operator to work inside the vehicle. In emergency conditions, you may deactivate the engine speed control by using the "off" position in speed control or by pressing the clutch or brake pedal as specific to application.

**MAINTENANCE AND SERVICE**



# MAINTENANCE AND SERVICE

## Attaching and Detaching a Trailer

### 5th Wheel (Platform) - Attaching the Semi-Trailer (for 5th wheels of SAF HOLLAND brand)

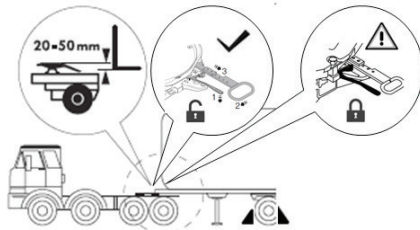

**Figure-1**

1- Block the wheels of the semi-trailer.  
2- Check that 5th wheel lock is open. The port for the semi-trailer pin should be open. (see Figure 1)

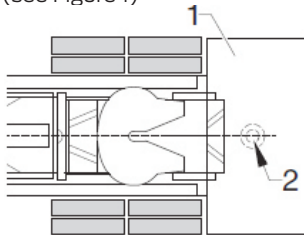

**Figure-2**

3-Position the truck in front of the semi-trailer.

(see Figure 1 and Figure 2)  
4-Position the vehicle so that there is a clearance of 20 to 50 mm between the bottom of the semi-trailer and the 5th wheel platform (see Figure 1)

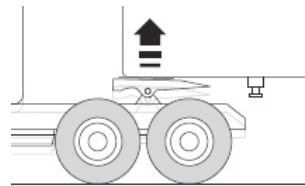

**Figure-3**

5-Lift 5th wheel with the help of the air suspension until the semi-trailer is slightly raised. (see Figure 3)

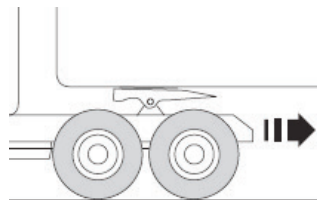

**Figure-4**

6- Reverse the vehicle slowly until 5th wheel coupling engages. (see Figure 4) The spring safety lever should return to its original position automatically. (see Figure 5)

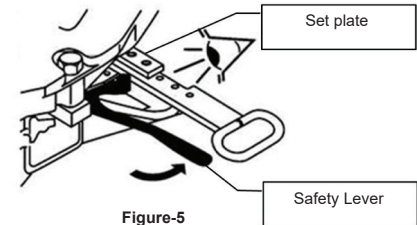

**Figure-5**

7- Get off the vehicle and visually check that 5th wheel lock has fully engaged. If the lock is fully closed, the safety lever should be in the upper position and the small adjustment plate on the lock lever should contact 5th wheel platform. (see Figure 5 and Figure 6).

As shown in Figure 6, the latch on the safety lever should be in the upper position.

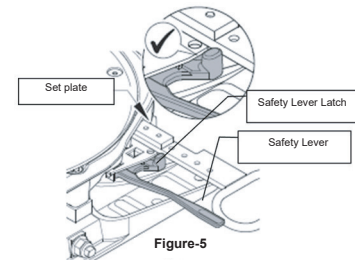

**Figure-5**

# MAINTENANCE AND SERVICE

## Attaching and Detaching a Trailer

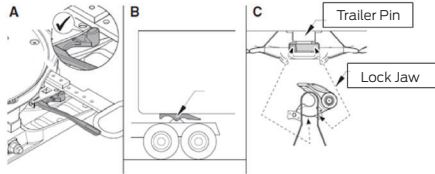

Figure-7

8- As shown in Figure 7, carry out the visual check for fully locking in order (A, B, C).

Check A: Check the safety lever, the latch on the safety lever and the adjustment plate. The safety lever and the latch on the safety lever should be in the position shown in Figure 7-A.

Check B: There should be no gap between the semi-trailer and 5th wheel.

Check C: The Locking Jaw should cover the semi-trailer pin securely.



Figure-8

9- Perform a starting test. Apply the brakes of the semi-trailer and start the truck at low gear; the semi-trailer should not be detached.

**CAUTION**

If any of the above conditions are not met, restart the entire locking procedure from the 2nd step. The starting test is not sufficient for secure locking. Visual checks should be performed. If the locking procedure is not completed successfully, a secure connection cannot be made (see Figure 9). The tag on the lock lever should be checked during visual checks.



Figure-9

10- Connect the supply lines and connection cables between the truck and the semi-trailer.

11- Complete the procedure for attaching the semi-trailer as per the instructions of the vehicle manufacturer.

**CAUTION**

Attach the cables in such a manner that the pressure air and hydraulic hoses are not tense, they are not bent or rubbing and the canopy can easily follow the trailer in curves, etc. Pay attention to the voltage of the consumers on the semi-trailer before

- connecting the cable.
- 5th Wheel (Platform) - Detaching the Semi-Trailer (for 5th wheels of SAF HOLLAND brand)
- 1- Park the vehicle on flat and solid ground.
  - 2- Secure and support the semi-trailer as per the instructions of the vehicle manufacturer.
  - 3- Disconnect the supply lines and connection cables between the truck and the semi-trailer.
  - 4- Unlock the 5th wheel lock with the opening lever, (see Figure 10-11)

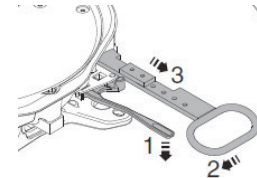

Figure-10

5- Press the safety lever down with your thumb -Arrow 1- and rotate the unlocking handle counter-clockwise - Arrow 2-. Extract the unlocking handle fully - Arrow 3- and attach the part near 5th wheel platform.

At this point, the adjustment plate should not contact 5th wheel platform, there should be a gap between them. (see Figure 10).

# MAINTENANCE AND SERVICE

## Attaching and Detaching a Trailer

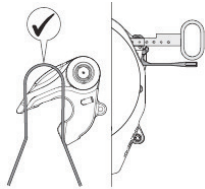

**Figure-11**

6- Make sure that the locking jaw is fully open for attaching/detaching the semi-trailer pin and the locking lever can be slid inside. (see Figure 11)

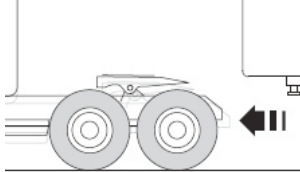

**Figure-12**

7- Drive the truck away from the semi-trailer slowly and straightly. (see Figure 12).  
8- Complete the procedure for detaching the semi-trailer as per the instructions of the vehicle manufacturer. (see Figure 13)

Note: Once the 5th wheel lock has been unlocked, the locking lever is ready to be slid inside again automatically (the unlocking lever can be slid inside), (see Figure 13)



**Figure-13**

Note: Figure 13 shows the unlock position for the locking lever. At this point, the adjustment plate is away from 5th wheel body and the safety lever is down. Figure 14 shows the closed position of the lock. At this point, the adjustment plate is contacts 5th wheel body and the safety lever is up.



**Figure-14**



### CAUTION

If there is a damage/flexion on 5th wheel locking lever and the safety lever, visit the workshop and do not attempt to attach a semi-trailer; a secure connection might not be established. Check all parts for wear/corrosion/damage.

### 5th Wheel (Platform) - Attaching the Semi-Trailer (for 5th wheels of JOST brand)

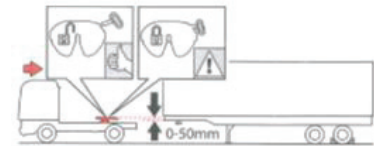

1- Block the wheels of the semi-trailer.

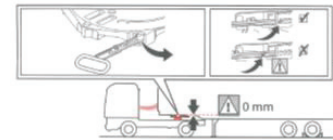

2- Pull the platform locking lever, the port for the semi-trailer pin will open.

# MAINTENANCE AND SERVICE

## Attaching and Detaching a Trailer

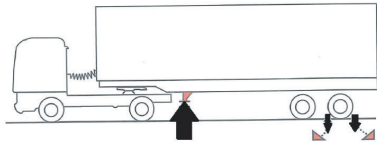

Reverse the vehicle until the trailer king pin is engaged on the seat on the 5th wheel. Spring release lever will return to its original position.



### CAUTION

Attach the cables in such a manner that the pressure air and hydraulic hoses are not tense, they are not bent or rubbing and the canopy can easily follow the trailer in curves, etc. Pay attention to the voltage of the consumers on the canopy/ the trailer before connecting the cable. Detaching the Semi-trailer

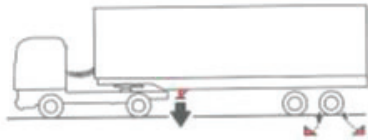

1- Block the wheels .

Lower the legs of semi-trailer so that they are on the ground. Disconnect the brake connections and wiring.

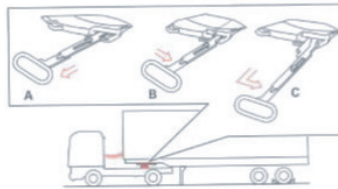

2- Pull the 5th wheel (platform) lock lever.



3- Drive the vehicle so that it will leave the trailer.



### CAUTION

If there is a damage/flexion on 5th wheel locking lever, visit the workshop and do not attempt to attach a semi-trailer; a secure connection might not be established. Check all parts for wear/corrosion/ damage.

### Trailer brake

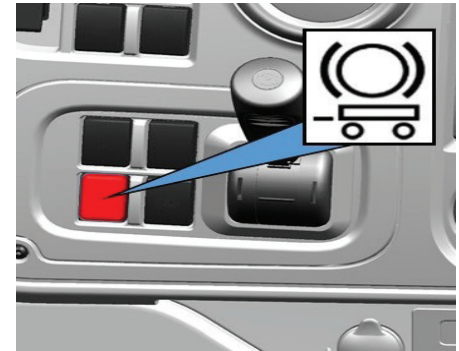

Eases the trailer connection or disconnection operation by braking the trailer while connecting the vehicle to the trailer or disconnecting it from the trailer

### Attaching the Semi-Trailer:

1- Bring the vehicle close to the trailer at a distance where you can install the air hoses and connect the air hoses of the trailer and vehicle.



# MAINTENANCE AND SERVICE

## Attaching and Detaching a Trailer

2- After performing the air connections, press the trailer brake switch on the center console of your vehicle, trailer brakes shall be active when you press the switch.

3- Then, perform the connection by aligning the 5th wheel (tray) of the vehicle to the trailer connection pin.

If the  icon on the display is illuminated, this means a fault in the system.



### CAUTION

System shall not be activated when the button is pressed below 8 km/h. A Dimmed light on the semi-trailer switch is illuminated continuously is for control purposes. A yellow light shall be illuminated when the switch is pressed.

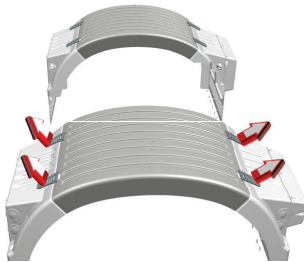

### CAUTION

Remove the rear fender upper part when you use the vehicle with a semi-trailer.

In case of adding or not subtracting functions to the trailer connectors; check that the gasket which provides leak tightness in trailer connectors is fitted correctly in place.

Ignition shall be turned off when the electrical connection of the trailer is performed.

### Greasing (for 5th wheels of SAF HOLLAND brand)

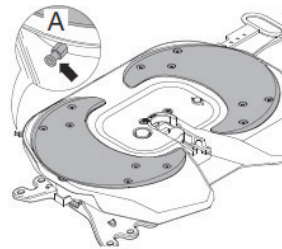

The surface of the platform should be greased with a sufficient quantity of durable, high pressure <NLGI Class 2> grease containing MoS2 or graphite additives prior to the first attachment of a trailer.

Without detaching the semi-trailer, grease through the nipple near the platform regularly at every 10.000 km.

- Clear the used grease on the surface with a scraper before each lubrication.
- However, the greasing periods should be adapted to the relevant operating conditions; shorter or longer intervals are possible.

### Greasing (for 5th wheels of JOST brand)

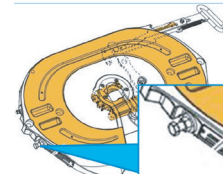

At every 10,000 km:  
Apply grease from the grease fitting on the side of the 5th wheel (platform) without detaching the trailer. Every 50,000 km for vehicles used in normal operating conditions.

# MAINTENANCE AND SERVICE

## Attaching and Detaching a Trailer

Every 25,000 km for vehicles used in heavy operating conditions Detach the semi-trailer. Remove the grease on 5th wheel (platform) and king pin. Apply grease to the areas shown with yellow color on the illustration.

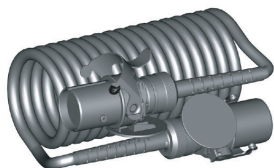

### WARNING

Attach the cables in such a manner that the pressure air and hydraulic hoses are not tense, they are not bent or rubbing and the canopy can easily follow the trailer in curves, etc.

Pay attention to the voltage of the consumers on the canopy/trailer before connecting the cable.

**A 15 – 15 pin connector shall be used in vehicles with ADR.**

Contact Authorized Workshop when you want to install Trailer Axle Lifting function on the vehicle.



### WARNING

Upper part of the live axle fender with 3 parts is advised for operation without trailer.

The upper part shall be removed when the vehicle is operated with trailer and during the removal/installation manoeuvres of the trailer to the vehicle.

FORD OTOSAN will not be responsible for any damages to occur in the upper part during use with a trailer.



### WARNING

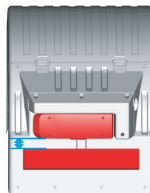

In tractor vehicles, the distance between lower side of the stop lamp on the rear left fender and upper side of the license plate's sheet plate should be 40 mm.

## Connection of a Trailer



### CAUTION

Always have the brake compatibility test performed at an Authorized brake test center that is capable of taking compatibility graphics.



### CAUTION

If you shall connect a Trailer to your vehicle for the first time, have a brake compatibility test performed to prevent a brake force difference due to the difference of the systems. Otherwise, braking system of the Tractor or trailer may overheat and as a result, the life cycle of the system components may be reduced.

# MAINTENANCE AND SERVICE

## Attaching and Detaching a Trailer

### Trailer Tractor Vehicles - Coupling

Coupling (Rear Drawbar Coupling) is placed on the chassis rear cross and it shall be used together with the trailer tractor with rotating table (Fig.1) Ford trailer tractors use different types of couplings.

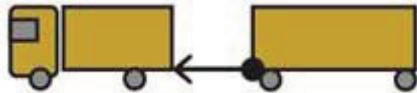

Figure-1



### CAUTION

The engine of your vehicle is designed to operate with EURO DIESEL complying with EN590 standards. Thus, usage of cheap diesel fuel causes a high risk for the function of the engine and its components. Use of bad fuel known as cheap fuel oil

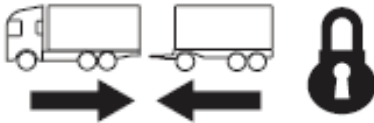

Figure-2

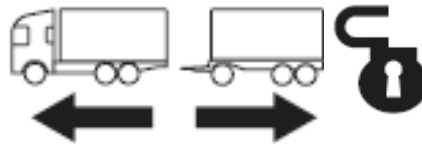

Figure-3

### VBG 8500 Brand Coupling, Rubber Brace and Rubber Brace Description Label

Coupling opening lever and the plastic cover to the right of the coupling is shown in Fig.4. Rubber brace and rubber brace description label on the front face of the coupling is shown in Fig.5 and Fig.6.

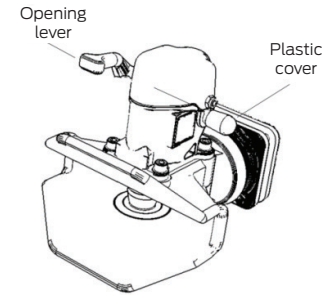

Figure-4

VBG 8500 brand couplings, shall be used with the rubber brace couplings delivered as installed on the component. Rubber brace has a hole on one end and the other end offers a handle and a slot. (See Figure -5)

# MAINTENANCE AND SERVICE

## Attaching and Detaching a Trailer



Figure-5

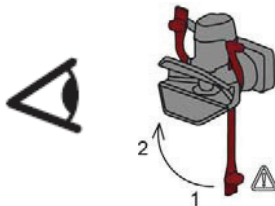

Figure-6

### Connecting the coupling - For Coupling with VBG 8500 Brand

1. Rubber brace of the coupling is delivered as installed under a plastic cover on the right-hand side of the coupling ex factory as shown in Fig.7.
2. There is a rubber brace description label affixed on the front face of the coupling (See Fig.6). Position No.; 1 and 2 can be seen on the label. Position No.1 indicates the position of the rubber brace when the coupling is open and Position No.2 indicates the position of the rubber brace when the coupling is closed.
3. If the brace is not installed under the plastic cover on the right hand side of the coupling, it shall be installed again. Remove the plastic cover on the right hand side of the coupling for this purpose (See Fig.6 and Fig.7)
4. Engage the holed area of the rubber brace to the pin under the cover and push the rubber brace down to the end of the pin (See Fig.7).
5. Install the plastic cover back (See Fig.7, Position No.1)
6. Perform the automatic locking of the trailer drawing eye and the coupling while the rubber brace is installed under the plastic plug. Small pin on the side of the locked coupling enters its seat after locking. A visual inspection shall be performed. Additionally, the larger pin that enter the drawing eye of the coupling shall be visually inspected, too (See Fig.7)

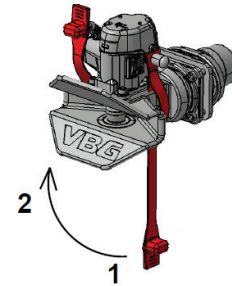

Figure-7

# MAINTENANCE AND SERVICE

## Attaching and Detaching a Trailer

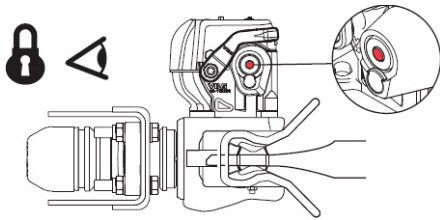

Figure-8

7. After locking the coupling with the drawing eye, put the rubber brace released on the right hand side of the coupling under the coupling carefully (See Fig.6, Position No.2)

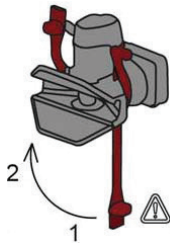

Figure-6

8. Hold the rubber brace from its handle and place the slot on the brace to the end of the opening lever of the coupling and push it to the end (See Fig.6, Position No.2).

### 9. Opening the coupling - For Couplings with VBG 8500 Bran

10. After stopping the vehicle and cancelling the trailer air/power connections, remove the coupling from the opening lever first by pulling it out from rubber brace slot handle installed on the coupling. After removing the rubber brace from the opening lever, open the coupling by rotating the coupling opening lever (See Fig.9). When the coupling is opened, the small pin on the left hand side of the coupling moves out of its slot automatically as shown in Fig.9. A visual inspection shall be performed. Then, check if the coupling lock pin is opened or not, too. Thus, the coupling shall be completely open. Leave the rubber brace at Position No.1 on Fig.6.

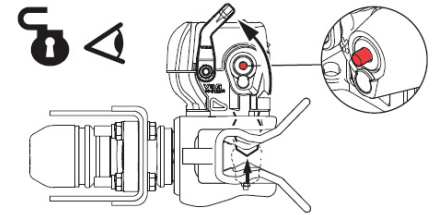

Figure-9



### CAUTION

Refer to the parts manual for lubrication and wear details of all coupling types. Refer to the parts manuals to connect and open the couplings of all models in addition to the information given here.

# MAINTENANCE AND SERVICE

## Attaching and Detaching a Trailer

### Connecting the coupling - For Couplings with Ringfeder Brand (4040 and 5050)

A drawing eye installed to the coupling with an open lock pin in order to lock the Ringfeder coupling. Coupling closes automatically. Locking is inspected visually, check if the lock pin of the coupling is inside the drawing eye. Small pins on the coupling shall enter inside after the locking of the coupling. A visual inspection shall be performed.

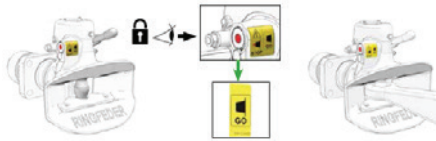

Figure-10

### Opening the coupling - For Couplings with Ringfeder Brand (4040 and 5050)

Open the opening lever of the coupling and see if the small pin on the coupling comes out automatically to open Ringfeder couplings. A visual inspection shall be performed. Also visually inspect if the coupling lock pin is completely opened or not, too. Remove the drawing eye (See Fig.10).

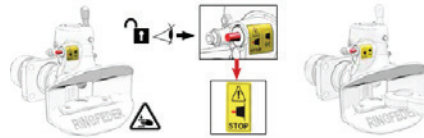

Figure-11

5

# MAINTENANCE AND SERVICE

## Fuel Quality and Refueling

### Fuel Tank

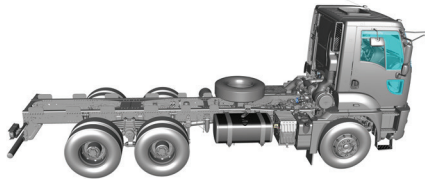

Original steel and aluminium fuel tanks approved by Ford Otosan should be used in Ford Trucks vehicles.

Using third party fuel tanks other than the tanks designed and test by Ford Otosan may render the warranty void for any fault on the fuel injection system and the vehicle.



### CAUTION

The engine of your vehicle is designed to operate with EURO DIESEL complying with EN590 standards. Thus, usage of cheap diesel fuel causes a high risk for the function of the engine and its components. Usage of bad quality fuel, also known as cheap diesel fuel, reduces the power of our engines and shortens their service life.

We advise using Euro Diesel (complying with EN 590 standards) to prevent any problem on the fuel system.



### CAUTION

Do not mix petrol in the fuel tank.

### Fuel Tank Flap (lockable)



Ford Fuel tank flap opens counter clockwise in a single action in single-stage. The flap returns to the position where you will lock it in a single action in single-stage when turned clockwise. Cleaning of the fuel tank is essential. Wipe the flap and surroundings without opening the fuel filler flap.



### CAUTION

Paraffin forms in the cold weathers in fuels without any precautions.

Paraffin not only clogs the filter elements, but also clogs the fuel pipes. It is very difficult to melt the paraffin once it is formed. Therefore, winter type diesel fuel should be used in the areas where the weather is always cold in winter.

### Tractor vehicles

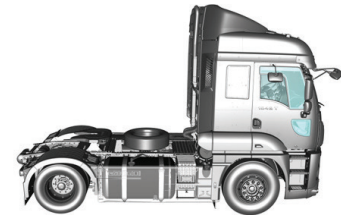

An aluminium fuel tank is available on the right of the vehicle. Vehicles with double tanks have auxiliary fuel tanks on the left.

# MAINTENANCE AND SERVICE

## Fuel Quality and Refueling

### Spark Arrester

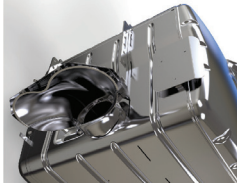

Spark arrester shall be installed at hazardous material loading, unloading locations and fuel stations during fuel filling or draining. When the vehicle is out of the station, the spark arrester shall be removed.

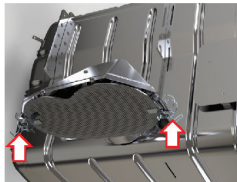

Put on a pair of gloves before installing spark arrester as the muffler is hot. Hook the spark arrester from its clips to the hangers in the muffler. Close the clips and retain the spark arrester to the exhaust.

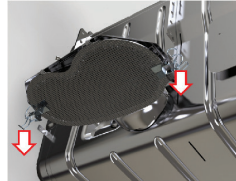

Put on a pair of gloves before removing spark arrester as the muffler and spark arrester is hot.

The spark arrester is removed from the exhaust pipe by loosening the brackets on it.



Spark arrester shall be cleaned by water jet to cleanse its pores after every 25 uses. Urea system is sensitive to dirt, dust and soil. During urea filling, ensure that dirt, dust or contaminants do not go in the urea tank.



Various sensors and urea injector shall be available on the exhaust muffler. (On Eu5 vehicles the urea injector is on the exhaust pipe) When you wash your vehicle, do not apply water jet on the urea injector on the muffler, sensors and the electric connections.

DOC, DPF and SCR catalyst are available in the exhaust muffler. These parts are ceramic-based bricks, and it is definitely not allowed to wash these parts. Do not attempt to wash inside the muffler from the muffler outlet or from the injector housing by removing the urea injector.



# MAINTENANCE AND SERVICE

## Cleaning of Exhaust Filter

### Cleaning of Exhaust Filter

The exhaust filter retains the smut coming from the exhaust gas and decreases the emission values. With the exhaust filter cleaning operation which can be performed automatically or manually, the smut retained in the filter is burned with regular intervals so that the filter is emptied before filling up and being clogged. In this operation, the exhaust gas is heated by the engine and smut is burned.

Driver is informed about the exhaust filter cleaning of the vehicle through the messages displayed on the indicator panel and explained in detail in the following sections



#### WARNING

Since the exhaust gas temperature is high during the exhaust filter cleaning; ensure that the vehicle is not in the same place with flammable (dry grass, leaves), inflammable and explosive materials or in enclosed space. Otherwise, fire risk may occur.



#### WARNING

Ensure that vehicle exhaust cleaning is not performed in locations like hazardous material loading and unloading places or fuelling stations. When necessary, activate the exhaust filter cleaning blocking using exhaust filter cleaning prevention button.



#### WARNING

During exhaust filter cleaning and right after the cleaning; a metallic smell or crackling sounds may come out of the exhaust side.

**Automatic Cleaning of Exhaust Filter**  
Exhaust filter cleaning requirement is automatically determined according to the amount of soot accumulated in the filter, the distance the vehicle has travelled, amount of fuel consumed and the engine running hours.

In this case, exhaust filter cleaning starts automatically. During the automatic filter cleaning process, the instrument panel shall display green coloured exhaust filter cleaning symbol. When this symbol is displayed, vehicle should be driven normally.



#### WARNING

When you see the Exhaust filter cleaning symbol, you should continue driving normally; there's no need to idle the vehicle and wait.



#### WARNING

Fill rate of the exhaust filter is shown in the graphic available on 'Exhaust Information' screen. By this graphic, for which an example is given below, you may monitor the soot amount in the exhaust filter. When the graphic reaches 100%, your vehicle shall start the exhaust filter cleaning operation automatically, and the soot inside the filter shall be burned.

When the fill rate of exhaust filter exceeds 100%, 9th level of the graphic shall start to flash. You may continue normal operation of your vehicle in this case. Optionally, you may perform a manual exhaust filter cleaning on your vehicle. When the last level of the graphic is filled, final 2 levels of the graphic shall start to flash. In this case, your vehicle is prevented from performing an automatic exhaust filter cleaning to protect the exhaust filter. You shall have a manual exhaust filter cleaning performed as soon as possible. If the graphic does not go below 10th level after a manual exhaust filter cleaning operation, you shall take your vehicle to the service.

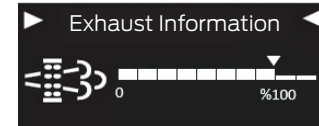

Graphic Example



#### WARNING

When the exhaust filter reaches a specific fill rate, automatic filter cleaning operation shall start and the soot inside the filter shall be burnt under high temperature. It may be difficult for exhaust gas to reach high temperatures and automatic filter cleaning may be required to be repeated in vehicles that are used with low loads, frequent start and stop operations, operated in idle for long periods and used in short distances (e.g. construction vehicles, mixer series).

# MAINTENANCE AND SERVICE

## Cleaning of Exhaust Filter

If your vehicle performs automatic exhaust filter cleaning 2 times (or more) in the same day, it is recommended to perform manual exhaust filter cleaning.

### Manual Cleaning of Exhaust Filter



The button in the middle console, shown with the red arrow above, is Manual exhaust cleaning button. You can perform manual exhaust filter cleaning of the vehicle using this button.



### WARNING

Exhaust gas temperature will be high during manual exhaust filter cleaning, so make sure that the vehicle is not in an enclosed space and the exhaust gases do not come into contact with any flammable, inflammable or explosive material.

Before starting manual exhaust cleaning, please make sure the following conditions are met.

- Vehicle speed must be "0"

- Parking brake must be applied
- Gear must be neutral
- Gas, brake and clutch pedals must not be pressed
- PTO must not be active
- Engine coolant temperature shall be above "40" or above
- There must not be any error codes that prevent exhaust filter cleaning  
After you ensure that the conditions above are met:
- Keep the manual exhaust cleaning button pressed for 3 seconds

After this operation, the vehicle check for suitable conditions for filter cleaning and start the manual filter cleaning.

When exhaust filter cleaning starts, the instrument panel shall display the exhaust filter cleaning symbol and "Exhaust filter is cleaning" warning for information. If the necessary conditions for exhaust cleaning are not met, "Conditions not suitable for exhaust filter cleaning" warning is displayed. If "conditions not suitable for exhaust filter cleaning" warning is received, the conditions above must be checked again. When the manual exhaust filter cleaning starts, the engine revolution of the vehicle will increase automatically. The operation shall continue as below:

- Heating 1 - 1200rpm 1 minute (minimum)

- Heating 2 - 1800rpm 2 minutes (minimum)
- Filter cleaning mode - 1800rpm 15 minutes (minimum) - 45 minutes (maximum)
- Cooling mode - 1200rpm 3 minutes (maximum)



### WARNING

You may monitor the time remaining to the end! of manual exhaust filter cleaning from the message on the instrument panel. As you may see on the sample message below, time remaining to the end of exhaust filter cleaning is shown in minutes.

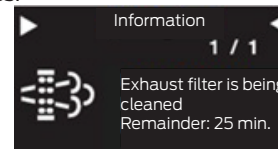

### Sample Message



### WARNING

Exhaust filter cleaning duration may change depending on the amount of smut in the filter and the heating time. Filter cleaning mode can take between 20 minutes minimum and 45 minutes maximum, depending on the amount of smut.

# MAINTENANCE AND SERVICE

## Cleaning of Exhaust Filter

When the manual exhaust filter cleaning operation is completed, the engine speed will again decrease to idle rpm. If you want to stop the cleaning operation; you can stop the operation by pressing gas, brake or clutch pedal or keeping the exhaust filter cleaning block button pressed for 3 seconds. In that case, vehicle shall decrease to normal idle rpm. Please see the details about Exhaust filter cleaning block button from the relevant chapter.



### WARNING

Since exhaust gas temperature shall be high and vehicle speed shall be "0" during manual exhaust filter cleaning, the indicator panel may display "High exhaust gas temperature, please pay attention during parking" information warning. The detailed explanation about this warning can be found in the warnings section.

### Exhaust Filter Cleaning Prevention

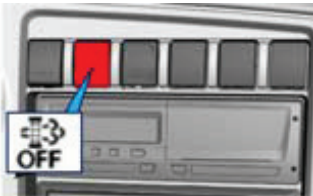

The button in the middle console, shown with the red arrow above, is Exhaust filter cleaning block button. You can prevent the exhaust filter cleaning of the vehicle using this button. When exhaust filter cleaning is prevented, the instrument panel shall display "Exhaust filter cleaning is prevented by the driver" warning. The detailed explanation about this warning can be found in the warnings section.



### WARNING

If exhaust filter cleaning is blocked by using Exhaust filter cleaning prevention button for a long time, the filter may fill with soot and clog up. When "Please remove exhaust filter cleaning prevention when possible" warning is displayed on the instrument panel, the prevention should be lifted and filter cleaning should be performed as soon as possible. Detailed information about this warning can be read in warnings section.



### WARNING

The purpose of exhaust cleaning block button is to prevent the vehicle from cleaning the exhaust whenever the vehicle is near a flammable, inflammable or explosive material.

To activate exhaust filter cleaning prevention,

- Keep the exhaust filter cleaning prevention button pressed for 3 seconds

When the blocking is activated, instrument panel displays "Exhaust filter cleaning is prevented by the driver" text.

To remove exhaust filter cleaning prevention,

- Keep the exhaust filter cleaning block button pressed for 3 seconds, or
- Keep the manual exhaust filter cleaning button pressed for 3 seconds (This will start manual exhaust filter cleaning operation) or,
- Shut off the engine of the vehicle and then restart it

You can confirm that the cleaning prevention is lifted when "Exhaust filter cleaning prevented by the driver" warning is not displayed on the instrument panel.

# MAINTENANCE AND SERVICE

## Urea System

5

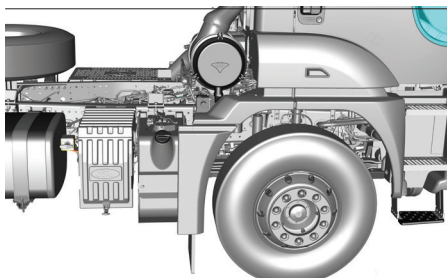

Your Ford vehicle with Euro 5 or Euro6 emission system is equipped with an Urea system.

Urea system is a selective reduction method that removes NOx gases, which are harmful to the environment and human health, from the exhaust gas.

DEF (Diesel Exhaust Fluid):

Urea system operates by spraying urea solution to the exhaust gas. Urea solution used in the urea system is defined with DIN 70070 and ISO 22241-1 standards.

Your Ford vehicle with Euro5 or Euro6 emission system is equipped with urea tanks with a capacity of 55 or 75Lt.



### WARNING

After turning off your vehicle's engine, do not turn off your vehicle's switch within 75 seconds so that the urea remaining in the Urea system can be drawn back into the urea tank. The urea remaining in the system may freeze in cold weather and damage parts of the Urea system. Cases where the switch is turned off before the specified 75sec time period are recorded in the vehicle memory with codes 99-3 and 99-4 under the ECM / ECOTORQ ENGINE modules on the driver screen MAINTENANCE tab.



### WARNING

Urea system is sensitive to contaminants.



Urea indicator

### Important Points:

#### Take extra care for cleaning.

Urea system is sensitive to dirt, dust and soil. During urea filling, ensure that dirt, dust or contaminants do not go in the urea tank.

Pay attention to prevent dirt ingress to the tank. Wipe the dirt and mud around the ap before opening the tank ap. Fill urea uid directly from its package (can). Make sure the funnel is clean if you will use a funnel. Do not use funnels contaminated with fuel.



If you prefer to filling with a funnel, keep a separate, clean funnel to fill urea available. Do not use funnels contaminated with diesel fuel to fill urea.

# MAINTENANCE AND SERVICE

## Urea System

Do not fill the urea tank with any material other than urea.

Fill the tank with adblue complying with DIN 70070 / ISO 22241-1 standard only.

- Do not fill the tank with diesel fuel.
- Do not add water to the tank to increase urea level.

### Quality of the fuel and engine oil used affects Urea system.

#### a-) Sulphur Content in the Fuel

Low quality fuel contains high sulfur ratio. Sulfur may cause blockage of catalyst, a component of the SCR system. You should use EuroDiesel only in your vehicle.

#### b-) Engine Oil

Low quality and/or wrong viscosity oil increases the oil vapour in the exhaust. This may cause blockage of the catalyst.

Catalyst is a non-serviceable component that cannot be cleaned. Exhaust box shall be replaced as a whole when it is blocked. Pay attention to the quality of the urea, fuel and engine oil used and apply all instructions about urea system with care in order to avoid damages with high costs.

If the exhaust temperature is consistently low (buses, delivery trucks), efficiency of Urea system may be reduced and ammonia may come out. Contact your workshop if you continuously smell ammonia.



User should carry out following precautions to prevent faults and damages in this system. Otherwise any faults occurring should be considered outside of the warranty cover and Ford Otosan will not take any responsibilities!



**The legal rules for the prevention of accidents are to be considered!**



### WARNING

Exhaust gas reaches very high temperatures during regeneration or while operating under high load. "HES" light shall be illuminated on the warning panel



of your vehicle in high exhaust gas temperatures.

Switching off your vehicle while this light is illuminated may cause damage to urea system components.

Average Urea Consumption			
	13L 480PS	13L 420PS	13L 420PS
Urea/Fuel Ratio Range			
Euro V	6-9%	6-9%	6-9%
Euro VI	8%	8%	7%

\* Average urea consumption values are calculated based on vehicle and dynamometer test results. These values may vary according to vehicle load conditions, environmental conditions (Ambient airtemperature and pressure, relative humidity), engine and urea quality.

# MAINTENANCE AND SERVICE

## Urea System







### WARNING

When improper urea or fuel is used or urea system is rendered inoperable because of contaminants mixed in the urea system, "MIL" lamp shall be illuminated on the instrument cluster and engine power shall be reduced by the engine control unit as the targeted emission values cannot be reached.

In order to avoid accident risk or problem, it is recommended to refill urea before the urea level falls below a specified critical level.

Engine power shall be reduced %40 by the engine control unit immediately after running out of all urea in the urea tank of your vehicle with Euro 5 emission level. High temperatures that may occur on the urea injector within this period may cause malfunction of the component.

Engine power shall be reduced %25 by the engine control unit when the urea level is reduced to a level under 3% in your vehicle with Euro 6 emission level. When the urea level is %0, vehicle speed shall be limited with 20km/h by the control unit.

Cluster Warning		Cluster Level Indicator		Inducement Level	
EURO6	EURO5	EURO5/EURO6		EURO6	EURO5
Urea level Low	Urea level Low		Fix	No inducement active	No inducement active
Urea level Low	Urea level Low		Fix	No inducement active	No inducement active
Fill up urea	Urea level Low		Blinking	No inducement active	No inducement active
Fill up urea	Fill up urea		Blinking	inducement active %75 torque reduction	No inducement active
Fill up urea	Fill up urea		Blinking	Severe inducement active Max. Vehicle speed 20 kph	inducement active %60 torque reduction

Restrains that are applied because of reduced/run out of urea as specified above shall be removed when urea is added. Urea solution complying with DIN70070/ISO22241 standards is used in your vehicle in order to reduce the exhaust emission. As this solution will be reduced in time, you shall check the urea solution level in your vehicle from the urea level indicator on the instrument panel and add urea before it is completely run off.

Usage of this solution is legally mandatory; and penalties may apply if you do not comply with this requirement.

# MAINTENANCE AND SERVICE

## Tires and Rims

### Tire profiles

A minimum profile depth is prescribed for tires by law. Observe the legislation for the relevant country.

For safety reasons, change your tires before reaching the legally advised minimum profile depth.



### WARNING

An excessively low tire profile may cause loss of handling at high speeds in case of rain or snow mud conditions. You may lose your handling and cause an accident in these conditions.

The Condition of the Tires

Check the following conditions regularly every 2 weeks and before a long haul to inspect the condition of the tires:

- External damage
- Cracks and bulges on the tires,
- Foreign material in the tire profile,
- Irregular wear of the profile



### WARNING

Do not forget that the external damages, bulges and cracks on the tires may cause blow-out of the tire. You may cause an accident in these conditions.



### CAUTION

Do not use radial and transversed tires mixed on your vehicle.

Use same type of tires on both sides of the same axle. Do not use radial tires on front axles if the rear tires are transversed. Wrong maintenance on the wheels may be extremely dangerous.

Follow the instructions below strictly:

- Do not attempt to replace the tires if you are not familiar with the required tools, and always follow the instructions.
- Deflate the tires completely before removing the valve. Thoroughly drain the fluid.
- Do not inflate the tires without a protection cage except normal pressure adjustments.
- Always check the tire pressures with the wheel is cold.

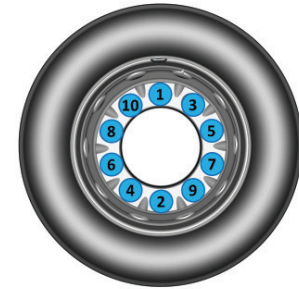

Check the wheel nut torque when you load the vehicle with full load for the first time. (750 Nm +/- 50Nm for front and rear wheels) Tighten the wheel nuts alternately.

### IMPORTANT

- 1- If the wheel nuts are removed and fitted back for any reason, the wheel nuts shall be checked 50 km after the operation. If the torque values are not suitable, the wheel nuts should be tightened to the suitable torque.
- 2- When a new or newly painted rim is used, tighten the wheel nuts after 1000 to 5000 km of driving.

# MAINTENANCE AND SERVICE

## Tires and Rims



### CAUTION

Please check the wheel nut torque when you load the vehicle fully for the first time.

Check the tire pressure periodically to prevent irregular tire wear.

Do not use radial and transversed tires mixed on your vehicle. Use same type of tires on both sides of the same axle. Do not use radial tires on front axles if the rear tires are transversed. Wrong maintenance on the wheels may be extremely dangerous.

Follow the instructions below strictly:

- Do not attempt to replace the tires if you are not familiar with the required tools, and always follow the instructions.
- Deflate the tires completely before removing the valve.
- Do not inflate the tires without a protection cage except normal pressure adjustments.
- Always check the tire pressures with the wheel is cold.

### Tire pressure

Check the pressure of all tires including the spare wheel. All tires should have the specified pressure, and tread depth of the tires should never be under the limit value (6 mm). Also check for damage on the tires. Adjust the pressure of your vehicle's tires by referring to the "Tire pressure" table.

### The Aging of the Tires

- Aging of the tires reduce the operation and traffic safety of the tires. Even unused tires are aged.
- Always replace your tires if they are aged more than 6 years.

### Tire Damages

Tire damages are usually caused by the following reasons:

- Aging of the tire
- Foreign material
- Usage conditions of the vehicle
- Weather conditions
- Oil, fuel, grease etc. - Contact with materials
- Dragging on the sidewalks

### Tyre/wheel replacement

Your wheel is specially designed to maximize the appearance performance. Ensure that equipment used for tire replacement do not damage the wheel surface. If it is required to replace the valve during the replacement operation, ensure that alloy wheel valve is issued in Ford Workshops is used.

### Wheel maintenance

Clean your wheel frequently. Thus, you may take maximum advantage of appearance performance. Never use brushes, sanders or acidic fluids that may cause scratches on the wheel during cleaning. A damp soft cloth and cleaning agents commonly used for vehicle cleaning is adequate as a special transparent paint is used on the wheel surface.



# MAINTENANCE AND SERVICE

## Tires and Rims



### WARNING

Your wheel is specially polished and covered with a transparent protection layer to protect its brightness. Never re-polish. This polishing operation would damage the protective layer on the surface. On vehicles with aluminium alloy wheels, wheel nut caps shall be removed with the wheel nut cap pliers delivered with the tools before removing the wheel nuts.



### WARNING

Please, observe the prescribed tire pressure for your vehicle. Very low tire pressure may cause blow-out of the tire at high speeds and loads. You can cause an accident and thus injuries to others due to this.



### CAUTION

Use snow chains only on the outer tyres of your vehicle.

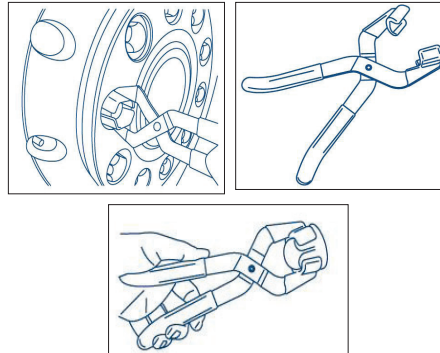

Remove the wheel nut caps with the special pliers provided in the toolbox of the vehicle for aluminium alloyed wheels.

Do not attempt to remove with sharp objects such as screwdrivers etc.

Check the tire pressure periodically to prevent irregular tire wear.

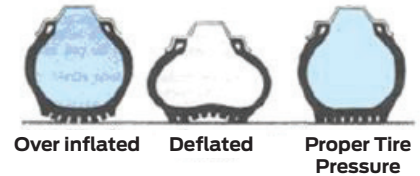

Low pressure cause wear on the shoulder areas of the tire. High pressure cause wear on the back areas of the tire.

# MAINTENANCE AND SERVICE

## Tires and Rims

### Wheel position replacement

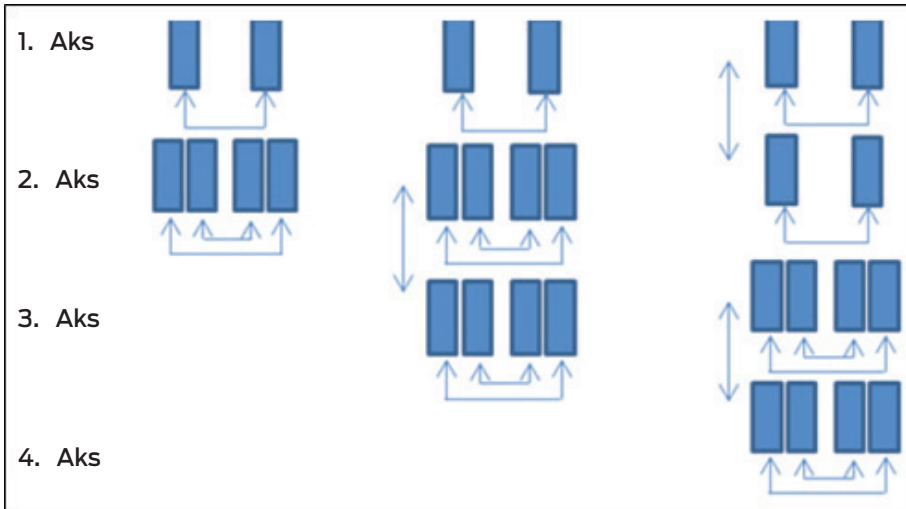

Wheel surfaces of your vehicle are polished specially and coated with protective transparent paint. Use your wheels in their original positions only. Or observe the following replacement chart.

A wheel replacement other than the application specified below shall cause appearance problems.



### CAUTION

As seen in the table, relocating your tyres at every 40,000 km will enhance the product life of your tyres.

# MAINTENANCE AND SERVICE

## Tires and Rims

TIRE PRESSURE [Bar]																	
Tire Size	Rim	Load Index	Tire	6,0	6,25	6,5	6,75	7,0	7,25	7,5	7,75	8,0	8,25	8,5	8,6	8,75	9,00
295/60 R22,5	9.00X22,5	150/147	Single	-	-	-	-	-	-	-	-	-	-	-	-	-	-
			Double	-	-	9000	-	10000	-	10500	-	11000	-	11600	-	12000	12300
295/80 R22,5	9.00X22,5	154/148	Single	-	-	-	-	6000	6200	6400	-	6700	6900	7100	-	-	-
			Double	-	-	10000	-	10700	11000	11400	11700	12000	12300	12600	-	-	-
315/60 R22,5	9.00X22,5	154/148	Single	5420	5600	5780	5955	6130	6305	6480	6650	6825	6990	7160	-	7330	7500
			Double	-	-	-	10000	10300	10600	10800	-	-	11600	12000	-	12300	12600
315/70R22,5	9,00x22,5	156/150	Single	5780	5975	6165	6355	6540	6725	6910	7095	7280	7460	7640	-	7820	8000
			Double	9685	10005	10325	10640	10955	11270	11580	11890	12195	12450	12800	-	13100	13400
315/80 R22,5	9.00X22,5	156/150	Single	5780	5975	6165	6355	6540	6725	6910	7095	7280	7460	7640	-	7820	8000
			Double	9685	10005	10325	10640	10955	11270	11580	11890	12195	12450	12800	-	13100	13400
13 R22,5	9.00X22,5	156/150	Single	5780	5975	6165	6355	6540	6725	6910	7095	7280	7460	7640	-	7820	8000
			Double	9685	10005	10325	10640	10955	11270	11580	11890	12195	12450	12800	-	13100	13400
12 R24	8x24	160/156	Single	6750	6970	7190	7410	7630	7850	8070	8280	8490	8710	8920	9000	-	-
			Double	12000	12390	12790	13180	13500	13960	14340	14720	15100	15480	15850	16000	-	-
325/95 R24	8x24	162/160	Single	7185	-	7665	-	8130	-	8590	-	9050	-	9500	-	-	-
			Double	13620	-	14520	-	15410	-	16280	-	17145	-	18000	-	-	-
385/65 R22,5	11.75X22,5	160	Single	6505	-	6935	-	7360	-	7775	-	8190	-	8595	-	-	9000
			Double	-	-	-	-	-	-	-	-	-	-	-	-	-	-

- Contact your dealership to select the correct size when you replace the tire.
- Always check the tire pressures with the wheel is cold.

# MAINTENANCE AND SERVICE

## Tires and Rims

5

DIAGNOSTIC CHART	
FAULT	POSSIBLE CAUSE OF THE FAULT
If the vehicle skids to the side when brakes are applied	• Brake adjustment is faulty
	• Tires have different pressure values.
If the vehicle drags to left or right when the steering is released	• Incorrect tie-rod adjustment (toe angles)
	• Irregular wear on the tires
	• Tires have different pressure values
If it is difficult to steer the vehicle	• Tire is underinflated.
	• Vehicle is excessively loaded.
	• Steering system shall be checked.
If the steering excessive play or looseness	• Wheel bearings are loose
	• Ball joints are loose
	• Bushings are worn
	• Track rod is loose/worn
• Steering gears or bearings are worn	
If the outer side of the tire is worn	• Excessive toe-out is applied
If the inner side of the tire is worn	• Excessive toe-in is applied
If the tire is worn on the shoulder areas	• Tire pressures are low.
If the tire is worn on the back areas	• Tire pressures are high.

DIAGNOSTIC CHART	
FAULT	POSSIBLE CAUSE OF THE FAULT
If the tires are worn on both sides	Vehicle is used with excessive load.
	Curves are taken with high speed.
	Vehicle is used with high speed.
	Wheel rotation is not applied.
If a tire is worn more than the other	• Pressure value of the worn tire is faulty.
	• Brake adjustment is faulty
	• Toe angles are faulty
	• Shock absorbers are faulty
• Wheel rotation is not applied.	
If the front wheels have excessive vibration	• Tire pressure is high.
	• Tires are flattened.
	• Balancing is faulty
	• Ball joints are worn
If the vehicle is shuddering	• Tire pressures are high.
	• Tires are flattened.
	• Balancing is faulty.

# MAINTENANCE AND SERVICE

## Tires and Rims

### Spare Wheel and Tire Replacement

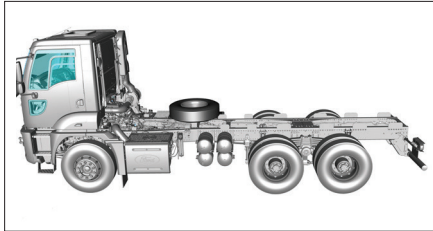

Spare wheel is on the chassis on your vehicle. Carefully lower the spare tire. Take necessary precautions to prevent the tire from falling over your foot.

It can be moved to any position on the vehicle by the vehicle owner when the upper structure will be installed.

Remove the Upper Spare Bracket before attaching a trailer to your vehicle.

### Jacking The Vehicle

Jack can be mechanically geared type or hydraulic type. Before lifting the vehicle, park the vehicle on a level ground and apply the park brake.

If the vehicle is on a slope and it is to be lifted without applying the parking brake, chock all other wheels.

The jack should be placed under the leaf spring as shown in the figure and must be placed on the ground firmly.



### CAUTION

If you need to get under a vehicle lifted by a jack, provide additional support under the frame pedestals. There may not be enough space under the front axle while replacing a flat tire. Place the jack under the leaf springs on the closest point to the axle when there is not enough space. Pay attention not to damage the steering linkages while lifting the vehicle with a jack. Use wooden blocks if required. Check for an obstacle under the vehicle when lowering the vehicle.

Do not jack the vehicle from the chassis arms.

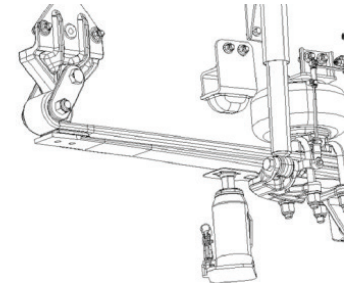

On vehicles with lowered ride height:

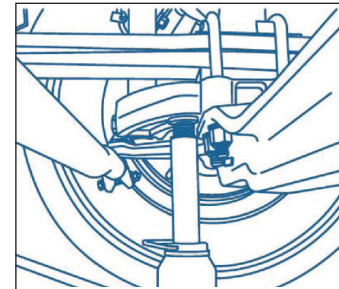

# MAINTENANCE AND SERVICE

## Tires and Rims

### Spare Wheel and Tire Replacement

5



Spare wheel is on the left side of the chassis on vehicles with single fuel tank. To remove the spare wheel from its seat, loosen four bolts connecting it to the holder with the 24 spanner on the toolbox. Spare wheel is hanged with a cable. To release the cable, install the wheel brace to the rotating arm. Turn the brace anticlockwise.

#### Installation:

Check the connection cable before installing the spare tire. Cable shall be replaced if it is damaged. Connect the end of the cable to the tire again. Lift the tire with the hexagon wrench and tighten all nuts.



#### CAUTION

Carefully lower the spare tire. Take necessary precautions to prevent the tire from falling over your foot.



Spare wheel is on the chassis on vehicles with an optional secondary fuel tank. Side skirt shall be removed to take the spare wheel out.

Remove the Upper Spare Bracket before attaching a trailer to your vehicle.

# MAINTENANCE AND SERVICE

## Tires and Rims

### Side skirt opening mechanism

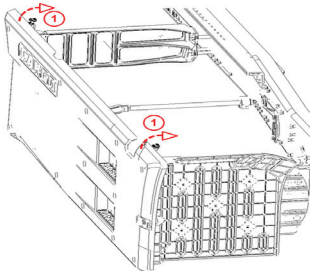

Side skirt panel is released of its locks with the movement of yellow locks on both front and rear sides to the direction of 1.

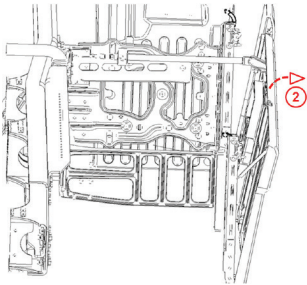

Side skirt panel is moved to the outwards of the vehicle on direction 2 after it is released of its locks.

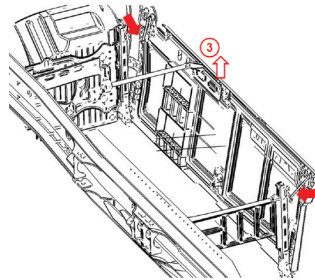

Side skirt panel is moved to the upwards on direction 3 after it is released from the rope hooks on the front and rear sides and it is released from its hinge connections.

# MAINTENANCE AND SERVICE

## Driver Cab

### Tilting The Cab:

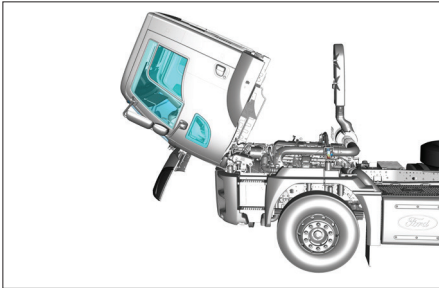

If you do not take the necessary precautions and pay necessary attention to the cab lifting procedures, this may cause fatal accidents.

### Before tilting the cab:

- Ensure that no one is standing in front of the vehicle.
- Ensure that adequate space is available in front of the vehicle.
- Ensure that no freely moving objects are available in the vehicle. Hard objects may break the windshield when they fall while the cab is being tilted.



### CAUTION

Do not work under the cab before tilting it completely. This brings a fatal accident risk.



### CAUTION

Do not tilt the cab uphill. As the gradient of the slope acts to move the cab in the closing direction, this may cause risk for the person under the cab. Always tilt the cab on a level surface. If the conditions require that the cab is tilted on a slope, place a safety element between the cab and chassis.



### WARNING

Doors are heavy components; if the doors are opened while the cab is tilted, abrupt opening of the doors may cause serious injuries. If the door should be opened, it shall be opened by supporting from the lower side and slowly. Always open the hood before tilting the cab.

### Vehicles without bed

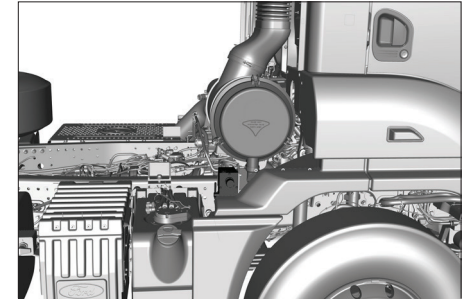

Cab tilt cylinder is located behind the fender on the right side of the vehicle.



# MAINTENANCE AND SERVICE

## Driver Cab

### Vehicles with bed

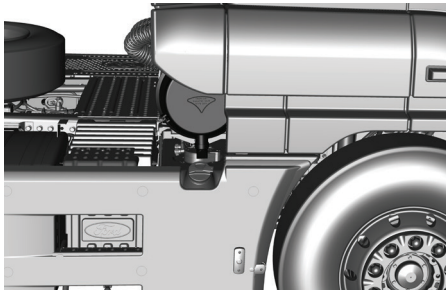

Cab tilt cylinder is located behind the fender on the right side of the vehicle.

Use the brace provided in the toolbox of your vehicle to tilt the cab and then to bring it to the driving position.

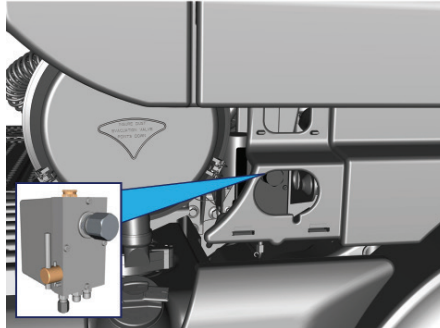

To use the jack, remove the specified cover.

### 1- On vehicles with manually controlled cab tilt cylinder:

#### Tilting the cab:

a) Open the hood of your vehicle.

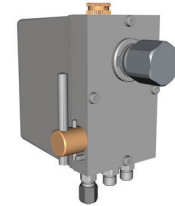

b) Lift the latch on the cab tilt cylinder down.



c) Using the wheel brace provided in the toolbox of your vehicle rotate the hexagonal head bolt on the cylinder in the direction of arrow until the cab is tilted completely.

# MAINTENANCE AND SERVICE

## Driver Cab

### Returning the cab to driving position:

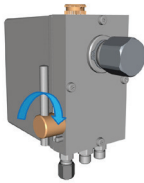

5

a) Lower the latch on the cab tilt cylinder up.

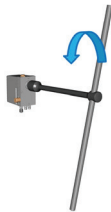

b) Using the wheel brace provided in the toolbox of your vehicle rotate the hexagonal head bolt on the cylinder.

c) If the  warning is illuminated on the display when you get in the vehicle, this means that cab is not locked correctly. Check it.

### CAUTION

Fully open and close the latch on the cab tilt cylinder while you are tilting and bringing the cab back to driving position, respectively. Do not tilt the cab or bring it back to driving position while the latch is in half-open or half-closed position. Otherwise, you may cause faults in the cab tilt cylinder.

# MAINTENANCE AND SERVICE

## Driver Cab

**On vehicles with power cab tilt cylinder (optional)**  
**Tilting the cab:**

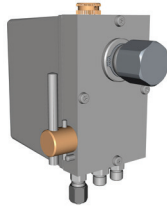

1) Lift the latch on the cab tilt cylinder down.

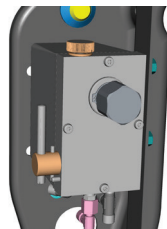

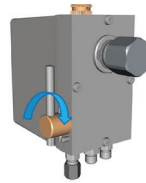

2) Hold the yellow button pressed To operate the power cab lifting system, ignition switch shall be at position 2, park brake shall be applied and gear shall be shifted to neutral.

**Returning the cab to driving position:**

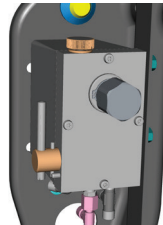

1) Lower the latch on the cab tilt cylinder up.



2) Hold the yellow button pressed if the  warning is illuminated on the display when you get in the vehicle, this means that cab is not locked correctly. Check it.

**DIAGNOSTICS:**

**On manually controlled tilt cylinders:**

**Cab cannot be tilted**

Check the position of latch on the tilt cylinder.

It shall be on the tilt direction.

- Tilt cylinder is also serves as the hydraulic oil tank. Open the cover after cleaning the surroundings of the upper cover. Check with your finger, your finger shall touch the oil.
- Check for oil leaks through the tilt cylinder, hoses, lift hydraulic line.
- Please visit a Ford Trucks authorized dealership if the fault persists.

**On power cab tilt cylinders:**

**Cab cannot be tilted**

- Check the position of latch on the tilt cylinder. It shall be on the tilt direction.
- Press the yellow button on the tilt cylinder.
- Check the fuse of the tilt cylinder.
- Check for oil leaks through the tilt cylinder, hoses, lift hydraulic line.
- Please visit a Ford Trucks authorized dealership if the fault persists.

# MAINTENANCE AND SERVICE

## Engine

5

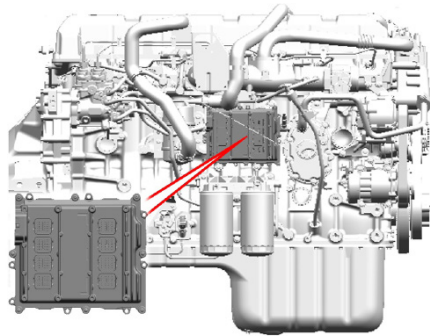

Engine management is provided by the state-of-the-art electronic control unit.



### CAUTION

Remove the plugs of electronic control unit before welding on the vehicle. Otherwise, there is a risk of permanent damage to the electronic control unit. Welding operations shall be performed while the main switch is off.

### Running-in

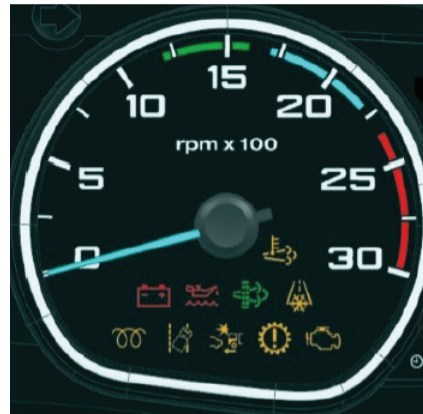

There is no need to perform a special application in the running-in period of the engine. Drive the vehicle with the proper gear so that tachometer remains in the green zone as always.

### Daily Inspections

- Check the coolant level. If the level is at minimum or less, add 50% distilled water and 50% antifreeze (WSS M97B44 D) mixture.
- Check the brake hydraulic fluid level, add brake hydraulic fluid if the level is at minimum or less.
- Check windshield washer liquid level, add clean water if the level is dropped.
- Check for any oil or liquid leaks in general.
- Check the operation of the service and park brakes.
- Drain the water and oil collected in the air tanks completely by pulling the drain ring.

# MAINTENANCE AND SERVICE

## Engine

### Weekly Inspections:

- Check the engine oil level.
- Check the tire pressures (while the wheel is cold), tread depth and damage condition on the tires.
- Check the clutch hydraulic fluid level, add hydraulic fluid if the level is dropped.
- Check the wear on the brake lining wear by looking through the lining inspection hole.
- Lubricate the semi-trailer connection platform.

### Monthly Inspections

- Check the power steering fluid level.

### Engine Oil Level Inspection

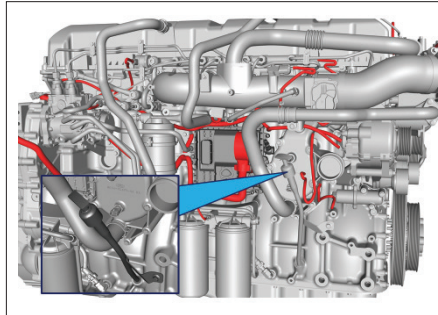

Engine oil level shall be inspected weekly. Engine oil dipstick is placed on the right side of the vehicle.

- Park the vehicle on a level ground. Switch off the ignition, apply the parking brake, and take the necessary precautions.
- Wait for 10 minutes to allow flowing of the oil to the oil pan.
- Tilt the cab.
- Take the dipstick out.
- Wipe with a lint-free clean cloth, install the dipstick again and secure it.

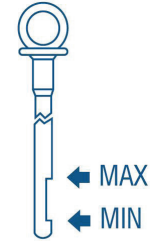

- The oil level must be between the MIN and MAX lines. The difference between "MIN" and "MAX" on the dipstick is 15 liters.



### CAUTION

Use oil with the specifications approved by Ford Otosan only for your engine. Using improper oil for your engine may cause serious and costly faults.

# MAINTENANCE AND SERVICE

## Engine

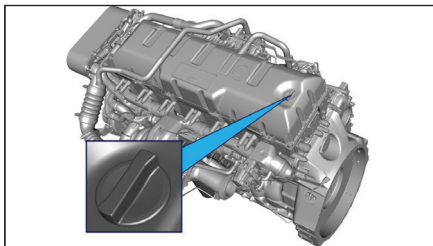

5

Add oil if the level is less than MIN, engine oil filler cap is on the cylinder head cover. Wipe the surroundings of the cap before opening it. Pay attention to cleanliness if you would use equipment such as measuring container, funnel etc.

### Fuel consumption value:

Oil consumption amount of the engine between 2 maintenances depends directly on the operating conditions of the vehicle (loaded-unloaded, short-long haul, fuel quality, engine oil quality). Under normal operating conditions, engine oil consumption up to 0.8 lt / 1,000 km between 2 maintenance operations is acceptable. These consumption values may vary under heavy operating conditions.

### Adding Fluid

When the engine oil level is reduced to critical level, red “Engine oil low”



warning shall be displayed on the instrument. In this case, engine oil shall be brought to required level by adding engine oil within 500 km maximum. We advise you to have the engine oil adding operations performed in Ford Otosan authorized dealerships.



### CAUTION

Do not replace engine filters and tamper with its connections when the ignition switch is at position 2.

Important Points:

1. When the warning light illuminates, lacking amount of oil in the engine is about 15 liters. Oil shall be add until the level observed on the dipstick reaches a level between MIN and MAX marks. Add oil gradually and in a controlled manner. Run the engine for a few minutes after each oil adding operation. Stop the engine, wait for 10 minutes, and check the engine oil level with oil dipstick.
2. Do not add oil more than required. Excessive engine oil may cause faults such as deterioration of seals, excessive heating, blocking of catalyst, oil leaks from various points on the engine.

3. Engine oils may lose their specifications if engine oils with different specifications and different brands are mixed. In order to prevent costly damages to your engine out of warranty cover, we recommend you to top up the oil in your engine with oils with the same brands and specifications when adding oil is required between 2 maintenance operations.



### CAUTION

When the engine oil level is reduced to the minimum level, “engine oil level warning light” is illuminated on the display 

In this case:

1. It is possible to drive up to the first rest stop. Road assistance is not required.
2. Vehicle shall be parked on a level ground on the rest stop area, park brake shall be applied and required safety precautions shall be taken.
3. When the vehicle has rested for 75 minutes with ignition off, oil shall completely flown to the oil pan.
4. Without turning the ignition / engine on, cab shall be tilted and oil level shall be measured with the engine oil dipstick.

# MAINTENANCE AND SERVICE

## Engine

### After the measurement:

- a. If the engine oil level is not under MIN level and oil level warning light is turned off after 75 minutes, it would be adequate to drive the vehicle to the authorized workshop as soon as possible. Road assistance is not required.
- b. If engine oil level is under MIN level, you shall add engine oil with the specifications given with the required amount. Oil level warning light shall be turned off after waiting for 75 minutes with the ignition off. Road assistance is not required for this application, too



### CAUTION

Excessive oil is harmful for your engine. This may cause overheating of the engine, damage to the seals and oil leaks from several points of the engine.

It may also cause blockage of the exhaust catalyst pores.

We advise you to have the maintenance of your vehicle by specialists in Ford Otosan authorized dealerships.

Engine oil pressure and oil level is checked by the sensors, and the driver is informed with a warning light in case of an abnormal condition.



### Low Engine Oil Pressure

Turn the engine OFF. Contact a Ford Trucks Authorized Dealership.



### Low engine oil level

Tilt the cab, and check the engine oil level with oil dipstick.



### Oil maintenance interval reached

Take your vehicle to a Ford Trucks Authorized Dealership as soon as possible for oil maintenance.



### Engine coolant temperature warning

This informs the driver about overheating of the engine. Stop the vehicle immediately and run the engine at idle for a few minutes. Check for coolant leaks. Stop the engine if the coolant temperature does not drop. Check the water pump drive belt, fan and shroud, and the coolant level. (see Engine coolant level) Contact an authorized dealer.

# MAINTENANCE AND SERVICE

## Engine

5



### Engine and drivetrain system malfunction

This indicates a malfunction in the engine and/or drivetrain components. Vehicle may continue normal operation or engine may reduce the power based on the severity of the fault. Please visit the nearest Ford Trucks authorized dealership.



### MIL (malfunction indicator lamp)

MIL indicates a malfunction in the vehicle central information system when illuminates in the instrument panel. Engine may be power off according to the seriousness of the malfunction. It is recommended that you ask the support of a Ford Trucks authorized dealership.



### MIL (malfunction indicator lamp) (In EURO-6 vehicles)

Before starting the engine:  
Engine malfunction lamp of your vehicle will self check by illuminating for 5 seconds when the ignition switch is on (before engine start).  
This is the lamp check phase.

The lamp will be dim out for 10 seconds after that.

Then it will be illuminating again for 5 seconds. This is the preparation phase.

If all data is ready for examination the lamp will stay illuminated for 5 seconds, if not, it will blink 5 times in 5 seconds. (This does not affect the function, and is not a sign of malfunction.)

Before going to the next phase, lamp will dim out for 5 seconds. If a malfunction is detected, lamp will show one of the 4 following behaviours till the engine start:

- Lamp will light up continuously. **It is recommended to you to drive to an authorized workshop in this case.**
- Lamp will light up 3 times in 5 seconds, and dim out for 5 seconds. **It is recommended to you to drive to an authorized workshop in this case.**
- Lamp will light up 2 times in 3 seconds, and dim out for 5 seconds. **It is recommended to you to drive to an authorized workshop in this case.**
- If there is no errors, it will light up for 1 second and dim out for 5 seconds.

### After starting the engine:

If there is an error, lamp will light up in 2 ways according to the error type,

- Lamp will light up continuously. **It is recommended to you to drive to an authorized workshop in this case.**
- Lamp will light up for 15 seconds, and dim out completely. **It is recommended to you to drive to an authorized workshop in this case.**
- If there is no error, lamp will not light up.

### Cleaning the engine:

Do not apply pressurized water to the sensors and electronic control unit while you are washing the outer surface of the engine with pressurized water. Water ingress to electronic units will cause short circuits on the electrical pins, thus malfunctions on the engine.



### CAUTION

Check the engine oil level before starting on your journey. Engine oil level is not displayed while driving.



# MAINTENANCE AND SERVICE

## Engine

### On-chassis fuel filter (Fuel pre-filter)

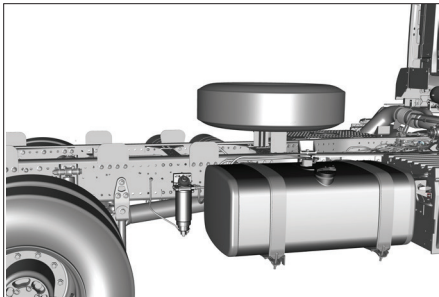

Fuel pre-filter performs the initial filtration of the fuel drawn from the fuel tank. Also, it separates the water inside the fuel and provides fuel separated from water to the engine. Filtered water is collected in the container under the filter assembly.



If the “water in fuel” warning light illuminates when the ignition is on, loosen or unclip the integrated water sensor under the filter assembly and close it when clean fuel appears. Tighten the water sensor securely when you are closing the tap. Otherwise, air may enter the engine, and this may cause fuel leak.



### WARNING

Care that is shown for the cleaning of the fuel filters will contribute the service life of main fuel filter on engine and fuel system of the engine.

Fuel does not flow to the engine and system takes air when the vehicle runs out of fuel or when the low quality fuel is frozen in the filter. Remedial operation required

### Tractor vehicles

### On-chassis fuel filter (Fuel pre-filter)

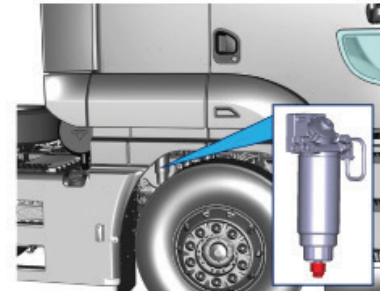

# MAINTENANCE AND SERVICE

## Engine

After performing the necessary corrective action, bleeding air from the system is performed by the hand pump on the filter head.

Press until hand pump is stiffened, and start the engine when the pump is stiffened.

### WARNING

Do not continue on starting attempts if the vehicle does not start in a few attempt. There may still be air inside the fuel line. Pump fuel with the hand pump, then restart again.

### CAUTION

Fuel that will be taken for the vehicles operating in cold climates shall be cold climate fuel resistant to waxing in cold weather. Otherwise, water inside the fuel will freeze and prevent flow of fuel to the engine; and the engine will not start.

### Engine coolant

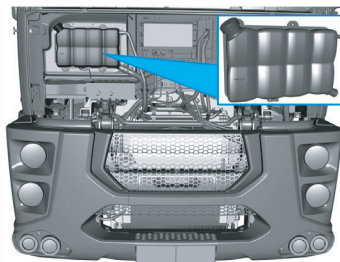

Engine coolant contains 50% antifreeze and 50% distilled water. Coolant circulates inside the engine block and cools the engine components. This fluid also cools the retarder oil in vehicles with retarder.

### CAUTION

Antifreeze does not prevent freezing of the engine in winter only. It also lubricates the water pump and extends its service life. Ensure that the antifreeze complies with the Ford specifications when you are purchasing antifreeze. Lime and other chemicals in the non-distilled water cause corrosion in the cast engine block.

### CAUTION

Freezing temperature of the 50% distilled water and 50% antifreeze mixture is  $-37^{\circ}\text{C}$ .

On colder climates, it is possible to achieve protection up to  $-50^{\circ}\text{C}$  by adjusting the mixture ratio to 40% distilled water and 60% antifreeze. Maximum antifreeze ratio is 60%, never exceed this ratio.

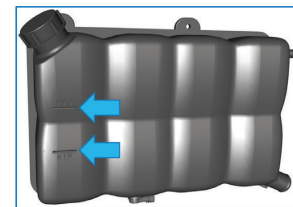

Cover of the engine coolant reservoir must always be tightly closed.

Engine coolant reservoir is under the hood. The coolant level should be between the MIN and the MAX marks when the engine is cold, and it shall be inspected daily.

If the coolant level is lower than the MIN mark, the x warning shall illuminate on the display. In this case:

# MAINTENANCE AND SERVICE

## Engine

- Stop the engine considering the road safety.
- Check the coolant level in the coolant reservoir under the hood.
- If the level is lower than the MIN mark, add 50% distilled water and 50% antifreeze until the level reaches between MIN and MAX marks. In the case of a malfunction in the low temperature circuit, a malfunction in the electrical pump or a water leak; the vehicle will start cutting down the torque. (For vehicles with 12.7 lt engine)



### CAUTION

Risk of Serious Injury:  
Coolant is pressurized and VERY HOT. Do not open the cover immediately. Wait at least half an hour and open the cover with a thick cloth or protective gloves, if available. Open the cover slowly first to discharge the pressure in the reservoir; then open the cover completely.

- Check under the vehicle for any coolant leaks.
- Tilt the cab, check the belts for any broken or excessively loosened belt.

If the fan cable breaks, fan rotates in maximum rpm; since this will worsen the fuel economy, it is advised you to go to service after the warning light goes on.



### CAUTION

Do not refill with water when the cooling system of a hot engine is empty or its coolant is missing. Add hot water if available, or wait until the engine is cooled.



### WARNING

The paper structure is distorted within one year and will not be performing the filtering function. The air filter clogged warning will be illuminated on the digital display when the air filter element is clogged.  
Contact a Ford Otosan Authorized Dealership for the replacement of the air filter elements after this warning is illuminated.

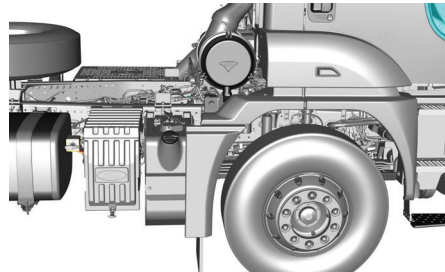

### WARNING

Always tilt the cab completely to replace air filters. Tilting the cab halfway may cause personal injuries. Ensure that the air filter cover is installed so that the dust draining hole faces downward.



### WARNING

Do not operate the vehicle with air filters removed. As the air drawn to the turbocharger and thus the engine shall not be filtered, this may cause serious and expensive malfunctions on components such as turbocharger and engine.

# MAINTENANCE AND SERVICE

## Engine

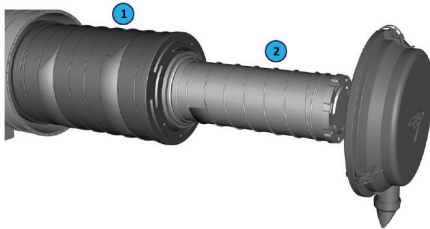

5

Air filter is composed of 2 components:  
1- outer filter  
2- inner safety element



**WARNING**

**Note:** Never expose the air filters to compressed air. Compressed air distorts the paper structure of the air filter elements and it may even tear them.

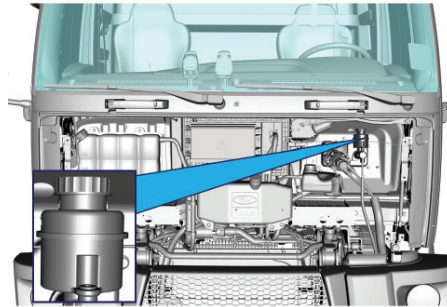

Clutch fluid reservoir is placed under the front hood. The level of fluid shall be up to the level mark on the reservoir.

Add fluid with proper specifications given if the level is low and close the cover tightly.



**WARNING**

Clutch fluid damages painted surfaces. Take necessary precautions to prevent spilling over the painted surfaces while adding fluid.

# MAINTENANCE AND SERVICE

## Engine

### Inspection and Cleaning of the Flyscreen

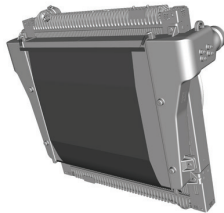

Flyscreen, placed in front of the radiator, is a component that resembles a curtain and it can be cleaned.

Its purpose is to prevent objects such as flies, dust, bugs etc. from entering directly to the radiator.

Inspect the Flyscreen as per the working conditions and clean it if it is dirty. Cleaning is performed by removing the flyscreen from the radiator and applying pressurized water or air to the flyscreen.

#### Removal of the flyscreen:

Pull the flyscreen lower bar downwards from its sides and take it out of the lower seats that connect it to the cooling module. Then, open the upper cover, remove the flyscreen upper connection springs and take it out by pulling it upwards from this area. In this way,

it would be possible to prevent the deformations on the cooling module that may be caused by the flyscreen springs.



#### CAUTION

Dirty flyscreen prevents air flow to the intercooler, thus to the radiator, and reduces the cooling capacity of the engine. Therefore, the cleaning procedure described above is important.

#### Engine Start/Stop buttons Engine

- Operation Conditions
- The ignition shall be at position '2'.
- The cab shall be overturned
- Doors must be closed
- Parking brake must be applied
- Vehicle speed must be "0".



#### WARNING

Note: In an event where one of these conditions are not met, the engine will not be engaged with Start Button.



1-Start  
2-Stop

#### You can do the following with Two Buttons:

- Engine Starting
- Engine speed increase
- Engine speed reduction
- Motor shutdown

#### The System Operation Principle is specified below:

The Function consists of 4 basic conditions;

1. When the ignition is in position 2, by pressing the Start button, the engine is engaged.
2. When the engine is engaged, the first long pressing the Start button will increase the engine torque. When the button is released, the engine torque is stabilized at the level.
3. First long press after increasing the engine speed reduces the speed, and it is kept constant at the point where the button is released.
4. Stop button is only used to halt the engine that is engaged. In any event, when Stop button is pressed the engine halts.

# MAINTENANCE AND SERVICE

## Engine

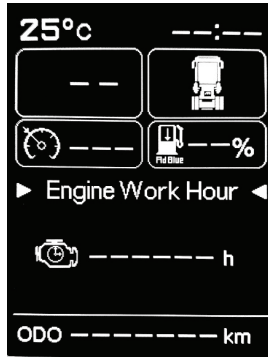

5 Engine total operating hours from the first operation of the engine

You may find more information on the maintenances and contact information for the Ford Trucks authorized dealerships in the Warranty Manual.

Distance and engine operating hours to the maintenance are displayed on the displays of your vehicle.

We advise you to have the periodical maintenance and repair operations on your vehicle performed in Ford Otosan authorized dealerships.



Your vehicle is suitable for using with a fuel with a bio-diesel ratio of 7% (B7).

# MAINTENANCE AND SERVICE

## Steering

### Steering Fluid

For vehicles with 12.7 lt engine

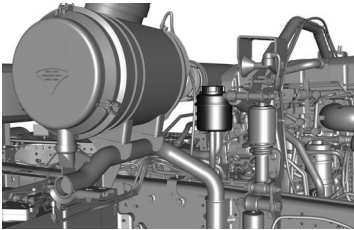

Steering fluid reservoir is located under the cab on the right side of the vehicle.

### For vehicles with 9 lt engine

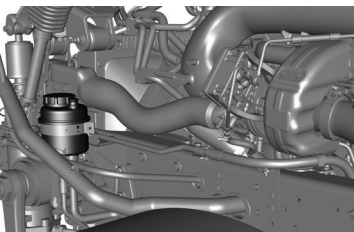

Steering fluid reservoir is located under the cab on the left side of the vehicle.

### Fluid level check:

1- Tilt the cab.



- 1- Cover
- 2- Wipe the surroundings of the with a clean cloth, open the clip



- 3- Take the dipstick out, wipe with a clean cloth, install the dipstick securely and take it out again.

4- The oil level must be between the lines shown in the figure.

Add fluid if the fluid level is low.

Steering system is very sensitive to foreign material such as dust, dirt etc. Pay maximum attention to cleanliness while checking the fluid level and/or adding fluid. Prevent dirt ingress to the system.

### Adding Fluid

- 1- Wipe the reservoir cover and surroundings with a cloth
- 2- Open the reservoir cover and add required amount of fluid.
- 3- Close the reservoir cover tightly.



### WARNING

Steering gear upper area  
Steering column joint connection area shall be cleaned with non-pressurized water or a brush. The mentioned area shall be protected if it is cleaned with pressurized water.

# MAINTENANCE AND SERVICE

## Towing the Vehicle

Towing of the vehicle requires specialist knowledge that is not explained in this manual. Make sure that the vehicle is towed by specialist staff.

5



Draw pin installation location on your vehicle is on the front grille panel.

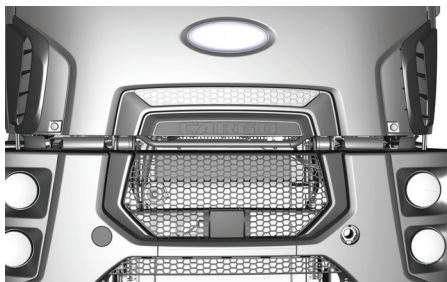

Remove the cover on the front grille panel to install draw pin.



Install draw pin by rotating it clockwise as shown in the figure.

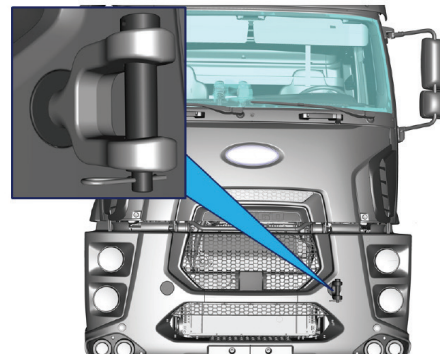

Remove the draw pin and attach the towing cable.

Make sure that the transmission is in neutral and in high range.

If the transmission cannot be shifted to neutral, you should remove the drive shafts to the axle.

If the vehicle should be transported on a trailer with a deep platform, the specified 4m height may be exceeded. Consider the maximum passing heights of the underpasses. You may cause an accident.



# MAINTENANCE AND SERVICE

## Towing the Vehicle Engine



### WARNING

Do not tow the vehicle crosswise.

### Risk of Accident

If the vehicle is towed with the engine is not running, the steering assist and air supplies will not be operating.

As this would require more steering effort, you may get out of the road or bump the towing vehicle in curves.

You may install an emergency steering pump.

If you agree on special signs with the driver of the towing vehicle before towing the vehicle, it will prevent occurring of these kind of problems.



### CAUTION

In order to tow the vehicle, the drive shaft connected to the live axle must be removed. For multi-piece drive shafts, it will only be sufficient to remove the rearmost drive shaft.

### While towing your vehicle



### CAUTION

- The drive shaft needs to be removed first before towing your vehicle.
- If the drive shaft is not removed, the movement shall be transmitted from the wheels to the transmission and operate the internal components of the transmission that is not pumping oil. In such a case, you may experience serious transmission malfunctions. This is considered out of warranty cover.



### CAUTION

Have your vehicle towed by specialists only. Improper towing may cause damage to your vehicle and you may experience serious accidents.

### Procedures to be Performed:

- If your engine is operating, have your vehicle towed as your engine is operated. If it is not possible to operate your engine, brake air pressure may be reduced after a while and this locks the emergency brakes.
- This may cause serious accidents and damages.
- To prevent this condition, discharge the emergency brakes before towing your vehicle or connect an air line to the air tubes of your vehicle if the specifications of the towing vehicle allows this.
- The drive shaft needs to be removed first before towing your vehicle.
- The key should be on the ignition switch and on position (1) as your vehicle has a steering lock.
- The vehicle should only be towed with a drawbar. Towing with soft, breakable materials cause a serious risk of accident.
- Do not exceed the speed limit specified by traffic law.

# MAINTENANCE AND SERVICE

## Electrical Systems

### Batteries

#### WARNINGS



#### **Danger of explosion**

Explosive gases form when the batteries are charged. Charge the batteries in well ventilated places only.



#### **Danger of explosion**

Avoid sparks!  
Do not work with open fires or lights near batteries. Do not smoke.



#### **Battery acid may cause burns.**

Use acid-resistant protective gloves!  
Neutralize the skin or cloth that the battery acid is spilt on with soapy water or a neutralizing material and rinse with water.



#### **Wear protective goggles.**

Electrolyte may be spilt on the eyes while mixing it with water. Wash your eyes with plenty of water and seek medical help immediately.



#### **Keep away from children**

Children cannot decide the risks involved with batteries and acid.



Observe the safety warnings, protection precautions and manners described in this manual when you are dealing with the battery.

#### DAMAGES TO THE ENVIRONMENT



Batteries contain hazardous material. Do not dispose with household waste.



Dispose the batteries without harming the environment. Return the batteries to a FORD OTOSAN authorized dealership or a collecting facility for waste batteries. Transport and store the batteries filled with electrolyte in upwards condition. Secure the batteries against turning over when you are carrying them. Battery acid may contaminate the environment by vaporizing from the air discharge holes.

# MAINTENANCE AND SERVICE

## Electrical Systems

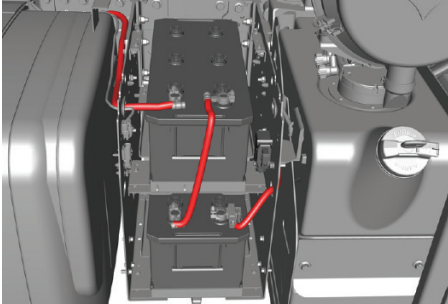

Batteries should always be charged as required in order to have a long service life. We advise you to use the circuit breaker next to the battery tray to preserve the service life of the battery when the vehicle is not going to be used for a long time. Check the battery voltage level if the vehicle is parked for a long period of time. 12.2 V voltage level measured in a battery indicates that battery charge level is too low. In this case, best method is to leave the vehicle running in the shortest possible time in order to charge the batteries.

### Disconnecting the battery terminals

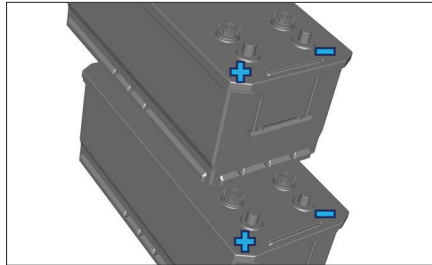

Disconnect the terminals after 5 minutes minimum when you stop the engine. This is needed to supply power to the Urea system that will operate after a while when the engine is stopped. Otherwise, your Urea system (or vehicle) may be damaged.

- Remove the key from the ignition switch.
- Turn off all consumers.
- Open the battery housing cover and remove it.
- Disconnect the negative terminals.
- Disconnect the positive terminals.



### WARNING

There is a risk of short circuit when the positive terminals of the battery contact the vehicle parts.

This may easily burn the explosive gas mixture. You and other people may get injured in an explosion.

Do not place metal parts or tools on the battery.

Disconnect the negative terminal first, and then the positive terminal while disconnecting the terminals.

Connect the positive terminal first, and the negative terminal then while connecting the terminals.

Do not loosen or disconnect the terminals when the engine is running.

**BATTERIES REQUIRE MAINTENANCE**

# MAINTENANCE AND SERVICE

## Electrical Systems

### Connecting the battery terminals



#### CAUTION

Remove the key from the ignition switch.  
Turn off all consumers.

Connect the positive terminals.

Do not confuse terminals!

- Connect the negative terminals.
- Fit the battery cover.

Perform the following when the power is disconnected (e.g. when the terminals are disconnected and connected again).

- Set the clock.

### Removing the battery cover

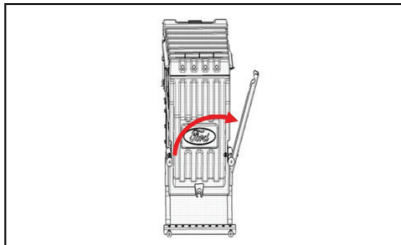

Open the upper connection profile of the step bracket under the battery cover in the direction of the arrow.

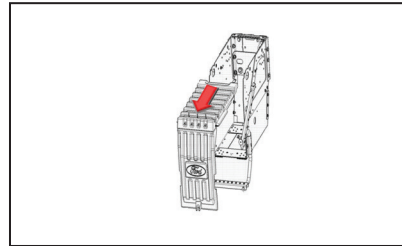

Then pull the battery cover to yourself in the arrow direction and remove easily.

After the battery replacement; if the replacement is made outside authorized service and parameter update is not performed, "replacement notification" signal is sent for 10 seconds.

In this case, the hazard lights button must be pressed 7 times within 14 seconds while the ignition is on.

### Checking the electrolyte level

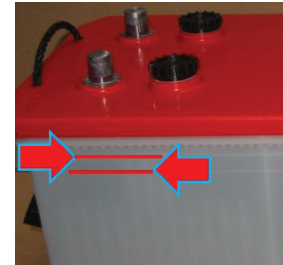

#### CAUTION

Battery box is white colored to provide the visibility of the liquid from outside. Pay attention to min./max. sign to understand whether the liquid level is adequate or not.

Check the electrolyte level every six months or 40.000 km.

Tap water decreases battery power. Only add demineralized or distilled water. Do not use a metal hone when you are filling the batteries. There is a risk of short circuit.

- Open the battery housing cover and remove it.
- Remove the plugs.
- Check the electrolyte level and correct if required.

# MAINTENANCE AND SERVICE

## Electrical Systems

- Install the plugs.
- Fit the battery cover.

### **WARNING**

Batteries are very heavy. You may drop the battery and injure yourself or others when you are removing or installing a battery. Thus, be careful when you are removing the battery and use the help of a second technician.

### **WARNING**

Make sure that the battery housing cover is closed. Ensure that the battery surface is always clean.

### **WARNING**

There is a risk of explosion because of the forming of explosive gases. Avoid sparks! Do not work with open fires or lights near batteries. Do not smoke.

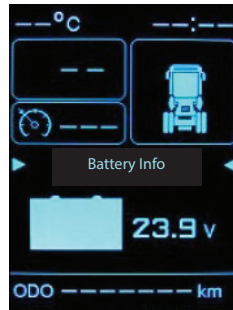

The blink of the battery status indicator shows that the battery charging level is very low.

The best method in this condition is to keep the engine on immediately for batteries to be able to charged

### **Using Jumper Cables**

If your battery is discharged and you want to start your engine with jumper cables, read the following instructions carefully to prevent damage to the charge system.

- The voltage of the spare battery (batteries) should be the same with your battery (your vehicle has a 24-V electrical system). Keep the spare batteries in a well-ventilated environment.
- Turn off all other consumers. Connect the jumper cables to the spare battery first. Connect the positive (+) terminal of the spare battery to the positive terminal

- of the vehicle battery, and negative (-) terminal of the spare battery to the negative terminal of the vehicle battery.
- Start the engine. Run the engine under 1000 rpm.
- Disconnect the negative jumper cable from the spare battery first, and then the vehicle battery. Disconnect the positive cable in the same way.
- If two vehicles are used, make sure that their bodies or frames do not contact each other.
- Do not approach the batteries with sparks or naked flames as the hydrogen will always be available.
- Connect the jumper cables as specified above to prevent sparks in the vicinity of the batteries.

Always use booster cables with insulated clamps and adequate size cable. Do not disconnect the battery from the vehicle's electrical system.

### **To start the engine:**

- a- Run the engine of the vehicle with charged battery with a high speed.
  - b- Start the engine of the vehicle with the flat battery.
  - c- Run both vehicles for a minimum of three minutes before disconnecting the
- Otherwise, you may damage electronic equipment like the engine electronic control unit or the digital instrument cluster.

# MAINTENANCE AND SERVICE

## Electrical Systems

### Fuse and Relay Table

J01	J06	R01		R03		R05		R07	R09	R12	R15
J02	J07							R08	R10	R13	R16
J03	J08	R02		R04		R06		R11		R14	R17
J04	J09									R14	R17
J05	J10	J11	J12	J13	J14	J15	J16				
F1	F10	F19	F28	F37	F46	F55	F64	R18		R19	R22
F2	F11	F20	F29	F38	F47	F56	F65			R19	R22
F3	F12	F21	F30	F39	F48	F57	F66			R19	R22
F4	F13	F22	F31	F40	F49	F58	F67	F73	F78	R20	R23
F5	F14	F23	F32	F41	F50	F59	F68	F74	F79		
F6	F15	F24	F33	F42	F51	F60	F69	F75	F80	R21	R24
F7	F16	F25	F34	F43	F52	F61	F70	F76	F81		
F8	F17	F26	F35	F44	F53	F62	F71	F77	F82	R21	R24
F9	F18	F27	F36	F45	F54	F63	F72	D01	D02		

5

# MAINTENANCE AND SERVICE

## Electrical Systems

No	Amp.	System	No	Amp.	System
F1	5	ABS/EBS	F20	7.5	SWITCH RELAY
F2	10	ELECTRONIC CONTROLLED AIR SUSPENSION/ STEERING ADDITIONAL AXLE UNIT	F21	20	A/C BLOWER
F3	3	COMFORT MODULE IGNITION	F22	7,5	ACCESSORY GEAR SELECTOR STATE
F4	7,5	CAMERA/RADAR	F23	10	HEATED SEAT / POWER MIRROR
F5	7,5	INT3	F24	20	AIR DRIER / FUEL HEATER
F6	10	AUTOMATIC TRANSMISSION IGNITION 9S ZF TRANSMISSION CONTACT	F25	20	WIPER MOTOR
F7	5	INSTRUMENT PANEL	F26	7,5	TRAILER IGNITION
F8	5	IGNITION SUPPLY OF ENGINE CONTROL MODULE	F27	15	MFS
F9	5	TACHOGRAPH	F28	30	WINDSHIELD HEATER-1
F10	3	TACHOGRAPH	F29	30	WINDSHIELD HEATER-2
F11	15	COMFORT MODULE	F30		SPARE
F12	2	TACHOGRAPH BMS CAN SUPPLY	F31	5	BCU
F13	7,5	INT3	F32	15	EBS/ABS
F14	3	CAMERA	F33	15	SUCTION LINE HEATER / ELECTRO HEATER
F15	7,5	AIR SUSPENSION	F34	20	ENGINE CONTROL MODULE
F16	10	ZF TRANSMISSION / 9S AMT TRANSMISSION	F35	7.5	WEMA
	25	ECOTORQ TRANSMISSION			
F17	5	INSTRUMENT PANEL	F36	15	NOX
F18	20	CONVERTER	F37	20	24 POWER OUTPUT
F19	5	A/C COMPONENTS	F38	7.5	INTERIOR LIGHTS

# MAINTENANCE AND SERVICE

## Electrical Systems

No	Amp.	System	No	Amp.	System
F39	3	EROGLOONASS SYSTEM	F55	5	WEBASTO TIMER
F40	10	REAR FOG LIGHT	F56	15	COMFORT MODULE
F41	10	STOPLAMPS	F57	20	WEBASTO PUMP
F42	10	PEAK SIGNAL	F58	5	BRAKE LOCK VALVE
F43	3	TRAILER AXLE LIFTING	F59	5	KNOB SHIFTER
F44	10	REVERSE GEAR	F60	15	FLASHER /HORN
F45	5	HAZARD WARNING	F61	20	A/C WET TYPE
F46	7.5	RIGHT PARKING LAMPS / DOME LAMPS	F62	20	WIPER MOTOR
F47	30	CAB LIFTING	F63	2	ALTERNATOR W SIGNAL
F48	7.5	LEFT PARKING LAMPS	F64	20	BCU1
F49	30	TRAILER 7 PIN SUPPLY	F65	20	BCU2
F50	10	TRAILER PARK	F66	20	BCU3
F51	5	HEADLIGHT ADJUSTMENT MOTOR	F67	20	BCU4
F52	5	WEBASTO TIMER MODULE PARK	F58	20	BCU5
F53	15	LIGHTER	F69	20	BCU6
F54		SPARE	F70	15	IGNITION SWITCH



# MAINTENANCE AND SERVICE

## Electrical Systems

No	Amp.	System	No	Amp.	System
F71	15	VGT/EGR	J2	40	LDWS/T ACHOGRAPH/CONVERTOR/ AUTOMATIC TRANSMISSION
F72	2	HILL HOLD MODULE	J3	40	LAMPS
F73	15	COMFORT MODULE CONVERTOR	J4	40	WEBASTO
F74	20	Radio	J5	30	AUTOMATIC TRANSMISSION
F75	5	RADIO SUPPLY AND ILLUMINATION / RAIN SENSOR	J6	40	CAB LIFTING/TRAILER
F76	10	DIAGNOSTIC	J7	60	BCU1
F77	5	BCU	J8	60	BCU2
F78	2	EROSLONASS SYSTEM IGNITION SUPPLY	J9	40	COMFORT MODULE/HORN/HAZARD/WIPERS
F79	20	AFTER SALES IGNITION SUPPLY (EXTERNAL)	J10	40	ABS/EBS/ECM
F80	15	AFTER SALES IGNITION SUPPLY (INTERNAL)	J11	40	IGNITION-1
F81	20	AFTER SALES IGNITION SUPPLY (INTERNAL)	J12	40	IGNITION-2
F82	2	HEADLAMP SWITCH	J13	20	POWER POINT (12 VOLT OUTLET)
D1	1	RETARDER	J14	40	IGNITION SWITCH / WEMA, VGT&EGR / SUCTION LINE HEATER/ELECTRO HEATER
D2	15	LEFT SIGNAL LIGHT	J15	60	HEATED WINDSCREEN
J1	40	RETARDER / COMFORT MODULE / ECAS / CLUSTER	J16	40	LIGHTER / AFTER SALES IGNITION SUPPLY

# MAINTENANCE AND SERVICE

## Electrical Systems

No	Amp.	System	No	Amp.	System
R1	40 A	IGNITION-1	R16	20 A	REVERSE GEAR
R2	40 A	VGT / EGR / WEMA / NOX	R17	20 A	PARKING LAMPS
R3	40 A	IGNITION-2	R18	40 A	BRAKING LAMPS -2
R4	40 A	WINDSHIELD HEATER 1	R19	20 A	BRAKE VALVE
R5	40 A	WINDSHIELD HEATER 2	R20	20 A	BCM TC AVAILABLE
R6	40 A	CAB TILTING	R21	20 A	CRUISE CONTROL OFF
R7	20 A	ROOF SIGNAL	R22	20 A	WIPER LOW SPEED
R8	20 A	AUX RELAY	R23	20 A	HORN
R9	20 A	TRAILER AXLE LIFTING	R24	20 A	REAR FOG LIGHT
R10	20 A	BLOWER1			
R11	40 A	IGNITION-3 (AFTER-SALE SYSTEMS)			
R12	20 A	ENGINE STOP			
R13	20 A	BLOWER2			
R14	20 A	WIPER HIGH SPEED			
R15	20 A	BRAKING LAMPS -1			

**Fuse and Relay Table (Battery)**

	No	Amp.	System	No	Amper	System
F1	F1	175	PROTECTION BETWEEN THE ENGINE HEATER AND STARTER	F1		N/A
F2	F2	150	PROTECTION BETWEEN THE ALTERNATOR AND STARTER	F2	100	STEERABLE ADDITIONAL AXLE
F3	F3	150	MEGA FUSE			

# MAINTENANCE AND SERVICE

## Changing Bulbs

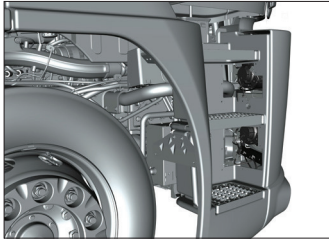

Use the covers on the door steps to replace the low and high beam headlamp bulbs.

high beam: DTRL-21W  
low beam :70W

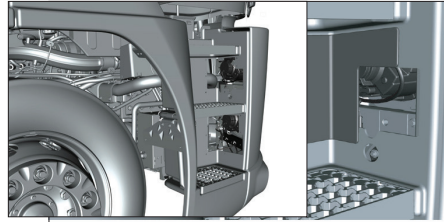

1- Pull the rubber part firmly

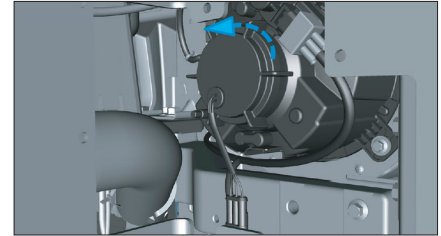

2- Open the headlamp rear cover by rotating it counter-clockwise

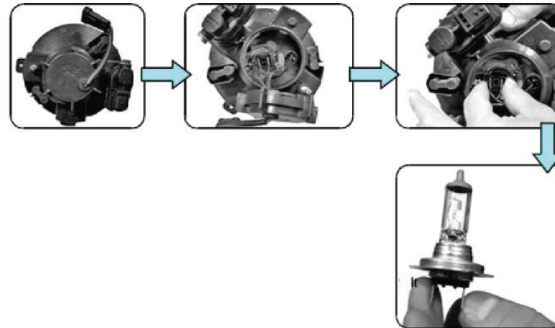

5

# MAINTENANCE AND SERVICE

## Changing Bulbs

### Brake Lamp

Turn Indicator Lamp (bayonet 21w)  
Brake Lamp (bayonet 21w)  
Fog Lamp (bayonet 21w)  
Reverse Lamp (bayonet 21w)  
Position Lamp (bayonet 5 w)  
Licence Plate Lamp (Led)  
Side Marker Lamp (Led)

5

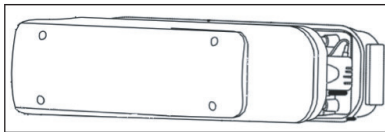
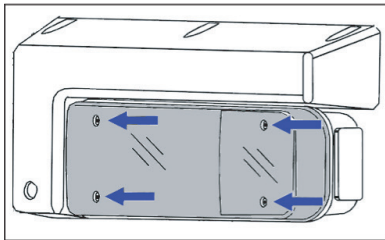

Remove the lens of the lamp by unscrewing its screws.

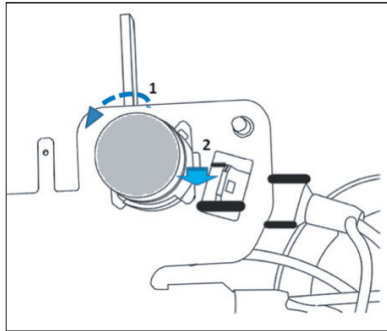

Rotate the bulb that will be replaced under slight pressure anticlockwise and remove it.

Install the new bulb by applying the same procedure backwards.

# MAINTENANCE AND SERVICE

## Changing Bulbs

### Dome Lamp

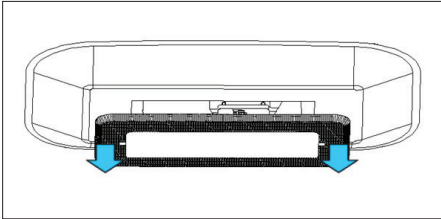

Remove the Led lamp and renew by applying the procedure backwards.



### CAUTION

Do not touch the bulbs with your hands when you are replacing the halogen bulbs, otherwise the bulbs will never work again.

### Reflector (Led)

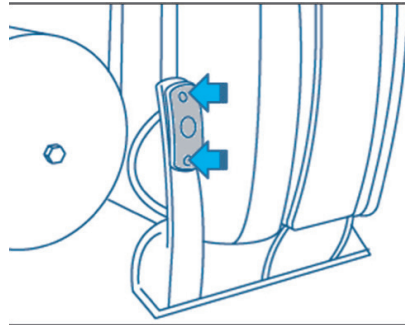

Unscrew the screws of the old reflector and renew it with new one.

# MAINTENANCE AND SERVICE

## Changing Bulbs

### Roof Lamp

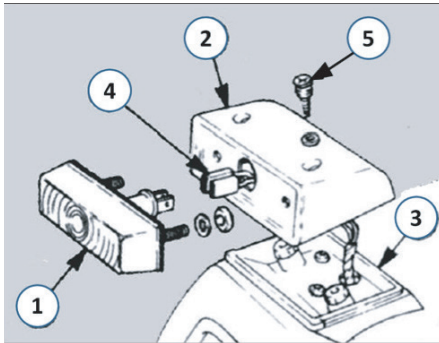

1- Lamp case 3- Bottom plate  
2- Top cover 4- Connector and harness

Take the upper cover off by removing 2 screws (5) on the lamp.

Detach the connectors (4) behind the lamp case. Take the lamp body off by removing 2 nuts.

Install new lamp case (1) by applying same procedure backwards.

### Front Fog Lamp

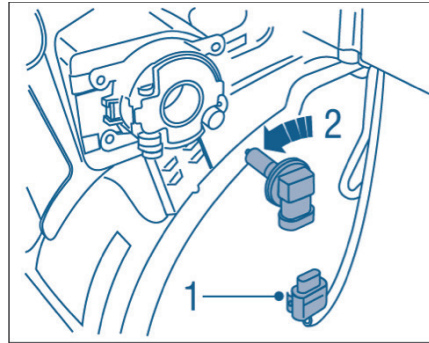

1- Detach the electrical connector from its socket.  
2- Remove the socket from fog lamp by rotating it counter-clockwise. (H1-70W)

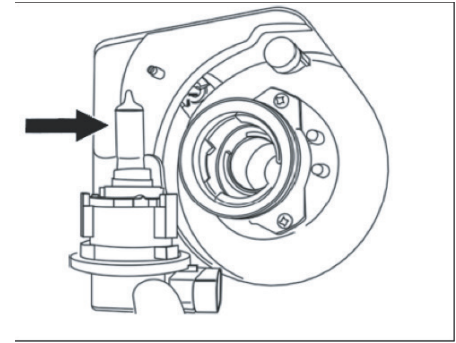

Remove the bulb and renew by applying the procedure backwards.

# MAINTENANCE AND SERVICE

## Changing Bulbs

### Turn Indicator Lamp

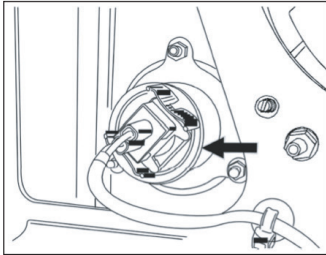

Detach the electrical connector from its socket.

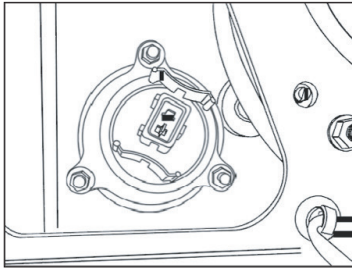

Remove the socket by rotating it counter-clockwise.

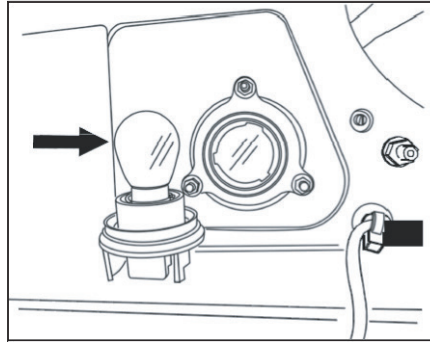

Remove the bulb and renew by applying the procedure backwards. (BAYONET-21W)

### Reading Lamp

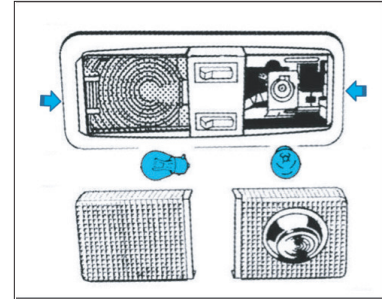

Release the lamp covers from the tabs by pressing them from the ends on the direction of the arrow to replace the reading lamp bulbs.

Remove the bulbs and renew by applying the procedure backwards.

### Reverse Buzzer

A buzzer is available on your vehicle in addition to the reverse lamp. Buzzer will sound intermittently when the vehicle is shifted to reverse.

# MAINTENANCE AND SERVICE

## Suspension Systems

5

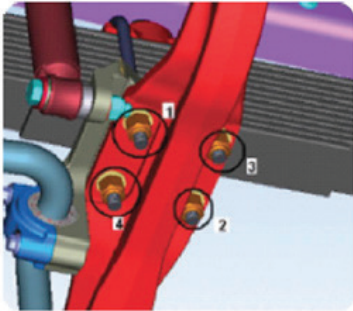

### WARNING

It is recommended, for a longer life of the springs, that you have the spring U-bolt nut torques checked between the first range of 2.000 km and 5.000 km (for once).



### CAUTION

#### Bump stop

Bump stop shall be inspected regularly. In case of wearing out a bump stop, drive to a workshop. Replace the bump stop.

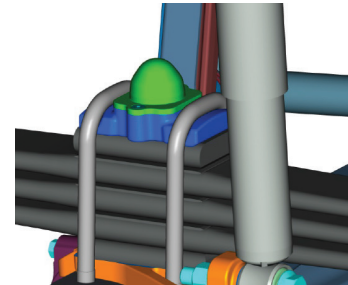
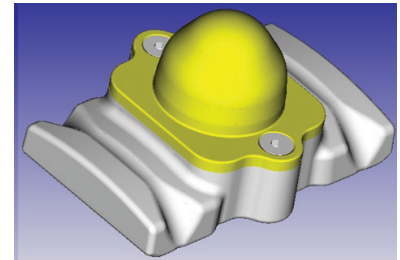



# MAINTENANCE AND SERVICE

## Suspension Systems

Type	1. Axle	2nd Axle	3rd Axle	4th Axle
35XXD			X	X
41XXD			X	X

### Wear Pad Check

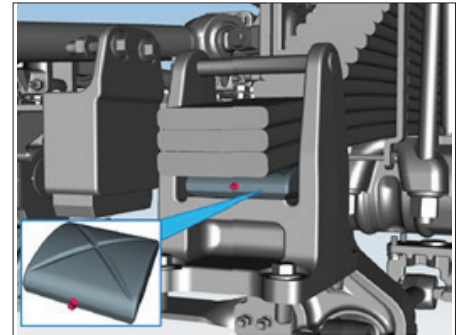







Check the grease condition of wear pads every week on X4 vehicles (except mixer vehicles), apply grease from the specified point if required.

# MAINTENANCE AND SERVICE

## Locations of the Tools in the Vehicle

5

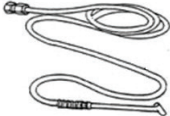
PARTS	PART NAME	LOCATION	
		W SLEEPER CAB	W/O SLEEPER CAB
	JACK	UNDER THE BED	BEHIND DRIVER'S SEAT
	TOOLBOX	UNDER THE BED	BEHIND DRIVER'S SEAT
	WHEEL NUT WRENCH	BEHIND PASSENGER SEAT	BEHIND PASSENGER SEAT
	LEVER	BEHIND PASSENGER SEAT	BEHIND PASSENGER SEAT

PARTS	PART NAME	LOCATION	
		W SLEEPER CAB	W/O SLEEPER CAB
	TRAILER CONNECTION WIRE	UNDER THE BED	BEHIND PASSENGER SEAT
	TIRE INFLATION HOSE	UNDER THE BED	BEHIND DRIVER'S SEAT
	WARNING LAMP	IN GLOVE BOX	IN GLOVE BOX

# MAINTENANCE AND SERVICE

## Questions and Remedies

FAULT	CAUSE AND REMEDY
<b>ENGINE IS STALLING</b>	Transfer pump does not intake, check the front filter. Check main fuel filter. The hole on the fuel tank cover may be clogged. Open it. There is water in the fuel. Replace if necessary. There is air in the fuel injection system. Check the fuel pipes and hoses. Freezing or air ingress in the fuel settling bottle filter or fuel intake lines; check and clean if required.
<b>ENGINE IS RUNNING ROUGHLY</b>	There may be air or clogging in the fuel pipes. Bleed air. Incorrect valve adjustment Intake manifold or air filter may be clogged. Clean or replace. There is water in the fuel. Replace if necessary. There may be clogging or damage in the exhaust pipes or the muffler. Have them inspected. Injector pump intake may be insufficient. Contact an authorized dealer.
<b>ENGINE IS DIFFICULT TO START</b>	Air cleaner is dirty. Clean or replace. Starter is faulty. Have it repaired. Battery discharged. Have it charged. Exhaust system may be clogged. Have them inspected. Pre-heater fault. Have them inspected. Fuel level low. Top up. Air in the fuel system. Bleed air.

# MAINTENANCE AND SERVICE

## Questions and Remedies

5

FAULT	CAUSE AND REMEDY
<b>ENGINE IS OVERHEATING</b>	Coolant level low. Top up. An object may be blocking the front of the radiator. Check it. Radiator cores may be dirty. Clean the radiator. Water pump belt adjustment is wrong. Have it inspected by an authorized dealership. Exhaust system may be clogged, have it inspected. Thermostat is faulty. Check it (and replace it, if necessary). Water pump is faulty. Have it inspected by an authorized dealership.
<b>LOW TRACTION</b>	Engine compression level is low. Have them inspected. Air cleaner is dirty. Clean or replace. Incorrect valve adjustment Drive to an authorized dealer.
<b>BLACKSMOKE FROM THE EXHAUST</b>	Air cleaner is dirty. Clean or replace. Intake manifold or exhaust system may be clogged. Have them inspected. Compression level is low. Cylinder head gasket leaks. Incorrect valve adjustment or valves faulty. Engine worn. Drive to an authorized dealer and have the necessary inspections performed. Turbo unit is faulty. Drive to an authorized dealer. ir leak on the Intercooler and / or hose connections. Inspect the hose and clamps. Diesel particle filter breakage (Euro-6 vehicles)

# MAINTENANCE AND SERVICE

## Questions and Remedies

FAULT	CAUSE AND REMEDY
<b>LOW OIL PRESSURE</b>	Oil pressure indicator is blocked or faulty. Have them inspected. Oil filter element is clogged. Replace. Oil strainer is blocked. Clean it. Oil pump is faulty. Check the backlash, drive shaft and operation of safety valve.
<b>POWER STEERING</b> <b>NOISE IN STEERING WHEEL</b>	Hydraulic oil level is low, top it up and bleed the system.  Drive to an authorized dealer and have the necessary inspections performed.
<b>STEERING WHEEL IS ROTATING ROUGHLY</b>	Check the tire pressure. Vehicle maybe overloaded. Check the suitability of load capacity. If load limits are not exceeded, drive to an authorized dealer.
<b>PLAY IN STEERING WHEEL</b>	Check for looseness in the steering system. Also have the adjustment inspected in an authorized dealership. Check the tire pressure and wheel alignment.
<b>ENGINE DOESN'T PRODUCE POWER</b>	Engine is faulty. Drive to an authorized dealer to resolve the fault. Exhaust or intake manifold is loose. Drive to an authorized dealer. Wrapping on turbine shaft bearings. It shall be repaired. Turbo pressure may be lower than necessary. You are recommended to contact nearest FORD OTOSAN authorized dealership.

# TECHNICAL SPECIFICATIONS

6

# TECHNICAL SPECIFICATIONS

## Labels

### Vehicle Identification Plate

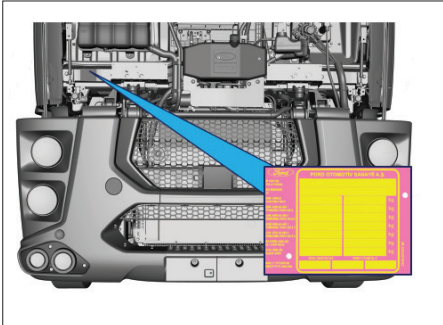

Vehicle identification plate is located under the hood in the front of the cab.

### Over the right chassis arm of the vehicle:

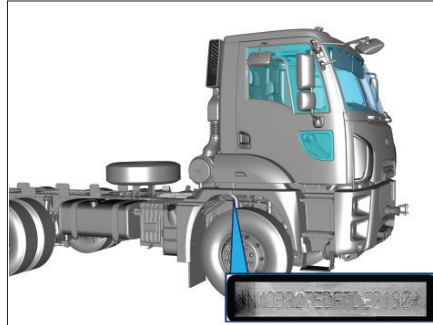

Chassis number is placed under the front hood and chassis right side arm, and it has 17 digits. Example: NM0K13TEDFBL12345

### Engine label

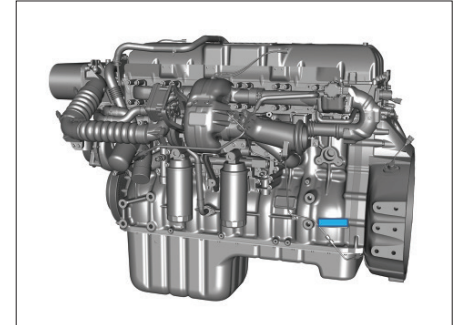

Metal label with the engine type and serial number inscribed on it is placed on the lower right side of the turbocharger intake pipe.

# TECHNICAL SPECIFICATIONS

## Fluid Filling Capacities

6

USAGE AREA	DESCRIPTON	CAPACITY		SAE NO.	FORD SPECIFICATION NO.	SPECIFICATION NO.
ENGINE OIL (INCL. OIL FILTER)	9 L EURO 6 VEHICLES (ROAD TRUCKS)	26 L		5W20	WSS-M2C219-A1	
	9 L EURO 6 VEHICLES (CONS. SERIES)	26 L				
	9 L EURO 5&3 VEHICLES (ROAD TRUCKS)	26 L		10W40 (Cold Climate: 5W30)	WSS-M2C944-A (Cold Climate: WSS-M2C212-A1)	
	9 L EURO 5&3 VEHICLES (CONS. SERIES)	26 L				
	12.7 L EURO 6 VEHICLES	46 L		5W30	WSS-M2C213-A1	
	12.7 L EURO 5&3 VEHICLES	40 L		10W40	WSS-M2C944-A (Cold Climate: WSS-M2C212-A1)	
TRANSMISSION		After an oil change	For initial fill after repair	75W80		Fully Syn. (TE-ML02E ZF)
	ECOTORQ 16S 2600	12 L	13 L			
	ZF 9S 1310 standart	7.5 L	8.9 L			
	ZF 9S 1310 with PTO	8.5 L	9.9 L			
	ZF 9S AMT 1315 standart	7.5 L	8.9 L			
	ZF 9S AMT 1315 with PTO	8.5 L	9.9 L			
	ZF 12 TX 2210 TD AMT-RETARDER	19 L	22.5 L			
	ZF 12 TX 2210 TD AMT-w/o RETARDER	11 L	12.5 L			
	ZF 12 TX 2620 TD AMT-RETARDER	19 L	23.5 L			
	ZF 12 TX 2620 TD AMT-w/o RETARDER	12 L	13.5 L			
	ZF 16S 2230 TO-with RETARDER	18.5 L	25 L			
	ZF 16S 2230 TO-w/o RETARDER	11 L	15.4 L			
	ZF 16S 2530 TO-with RETARDER	18.5 L	25 L			
	ZF 16S 2530 TO-w/o RETARDER	11 L	15.4 L			
Eaton 14409	8.5 L	8.5 L				
The reference values may change during the oil change.						
DIFFERENTIAL BOX	FORD XSS-510	18.5 L		85W140	J2360	J2360
	FORD XPT-330	23 L				
	FORD XPS-330 (32XXCD Tipper 8x2)	17 L				
	FORD XSS-330 (18XXT Çekici)	23 L				
	FORD XSS-470 (Tractor Vehicles)	12.5 L		75W85 75W90		



# TECHNICAL SPECIFICATIONS

## Fluid Filling Capacities

USAGE AREA	DESCRIPTON	CAPACITY	SAE NO.	FORD SPECIFICATION NO.	SPECIFICATION NO.
<b>REAR WHEEL HUB REDUCTION</b>	X4 AND X2 TRACTION VEHICLES (FO Axle)	3 L/hub	85W140		API GL-5
<b>WHEEL BEARING</b>	X4 VEHICLES	2 x 0.75 L	75W140	WSL-M2C192-A	API GL-5
<b>STEERING FLUID</b>	Vehicles with Single Steerable Axle Vehicles with 9l engine	3.5 L		WSS-M2C938-A	
	Vehicles with Single Steerable Axle Vehicles with 12.7l engine	4.5 L			
	Vehicles with Dual Steerable Axle Vehicles with 9l engine	9 L			
	Normal Climate Conditions	4.7 L			
<b>ENGINE COOLANT/ANTF (Pure Water + *Antifreeze)</b>	Engine Coolant (13L - with Retarder)	69 L		WSS-M97B44-D	
	Primary Cooling Cycle Total Water Amount (13L - without Retarder)	50 L			
	Primary Cooling Cycle Total Water Amount (9L)	40 L			
The reference values represent initial amount of oil. Total amount of coolant decrease in the event of an coolant change					
<b>CAB LIFTER OIL</b>		0.58 L		SLM-6C9100-A	
<b>HUB GREASE</b>	Front Disc Brake	650 g/wheel		WSS-MIC275-A	
	Front Drum Brake	650 g/wheel		WSD-MIC228-A	
	Tax Axle – (Except C6AS)	900 g/wheel		WSD-MIC228-A	
	Tax Axle – C6AS	650 g/wheel		WSS-MIC275-A	
	Drive Axle (Only 510 Type)	900 g/wheel		WSD-MIC228-A	
<b>GREASES</b>	Spare Tire Wire	(**)	Lithium-based	WSD-MIC228-A	
	Kingpin	15 g/pin	Lithium-based	WSD-MIC228-A	
	Axle Lifting Shaft	(**)	Lithium-based	WSD-MIC228-A	
	Leaf Spring Friction Pads	(**)	Lithium-based	WSD-MIC228-A	
	2nd Axle Steering Arm	(**)	Lithium-based	WSD-MIC228-A	
	Spring Friction Pads	(**)	Lithium-based	WSD-MIC228-A	
	Battery Terminal	20 g	Petroleum jelly		WSD MIC226 A
	Brake Shoe Slides	(**)	Copper Additive		
	Cab Lock Bushing	0.024 g/lock		WSD-MIC228-A	
	Door Strut	75 g/door	Poly Urea NLGI 2	WSD-MIC238-A	
	Door Locks, Latches	(**)	Lithium No. 1	SMIC-1021-A	
	-15 °C to -40 °C	(***)	Lithium-based	WSA-MIC160-D2 SS-M13P12-A	

# TECHNICAL SPECIFICATIONS

## Fluid Filling Capacities

USAGE AREA	DESCRIPTON	CAPACITY	SAE NO.	FORD SPECIFICATION NO.	SPECIFICATION NO.
CLUTCH FLUID	Clutch Fluid	0.37 L	FMVSS No.116	WSS-M6C57-A2	SUPER DOT4
A/C SYSTEM REFRIGERANT	9.0 L Engine	940 grams	J2776	WSH-M17B19-A	
	12.7 L Engine	890 grams			
A/C SYSTEM OIL	9.0 L Engine	150 -0/+20 cc		WSH-M1C231-B	
	12.7 L Engine	175 -0/+10 cc			
FUEL	Euro Diesel		TS EN590		
UREA			DIN 70070	WSS-M99C130-A	ISO 22241-1

6

(\*) Antifreeze ratio in the coolant shall be at least 30% to protect the engine cooling system against corrosion.

Engine coolant shall include at least 60% antifreeze to prevent freezing down to -52 °C.

(\*\*) This is used as required in maintenances.

(\*\*\*) Instead of lithium based chassis greases in operating conditions from -15°C to -40°C

**Refer to latest Ford Trucks Periodical Maintenance Sheet or contact a Ford authorized dealership for oil replacement intervals.**

# TECHNICAL SPECIFICATIONS

## Engine Specifications

9 LT 330 PS	
Number of cylinders	6
Displacement	9000cc
Bore	115mm
Compression ratio	17,6 ± 0,5:1
Minimum Engine Speed Without Load	600 ± 10
Maximum Engine Speed With Load:	2200 ± 20
Valve Clearance	Intake: 0.3 mm .
	Exhaust: 0,4mm
Ignition Sequence	1-5-3-6-2-4
Turbo	Euro5: Cummins HE400WG variable geometry
	Euro6: Borgwarner BV70 variable geometry
Oil Pressure	DIN 0.7-2bar
	DIN 2.1-3bar
	Max speed: 6 bar
Engine brake	27 kW/lit (2400 rpm)
Torque per unit liter	144Nm
PS per unit liter	37PS

12.7 LT 420 PS	
Number of cylinders	6
Displacement	12700 cc
Bore	130 mm
Compression ratio	17 ± 0,5:1
Minimum Engine Speed Without Load	550 ± 10
Maximum Engine Speed With Load:	1800 ± 20
Valve Clearance	Intake: 0.4 mm
	Exhaust: 2.4 mm.
Ignition Sequence	1-5-3-6-2-4
Turbo	Borgwarner BV70 variable geometry
Oil Pressure (100 °C)	600 rpm: 0.7 - 2 bar
	1100 rpm: 2.1 - 3bar
	Max speed: 6 bar
Engine brake	30 kW/lit (2400 rpm)
Torque per unit liter	169 Nm
PS per unit liter	33 PS

# TECHNICAL SPECIFICATIONS

## Engine Specifications

6

12.7 LT 480 PS	
Number of cylinders	6
Displacement	12700cc
Bore	130 mm
Compression ratio	17 ± 0,5:1
Minimum Engine Speed Without Load	550 ± 10
Maximum Engine Speed With Load:	1800 ± 20
Valve Clearance	Intake: 0.4mm
	Exhaust: 2.4mm
Ignition Sequence	1-5-3-6-2-4
Turbo	Borgwarner BV70 variable geometry
Oil Pressure (100 °C)	600 rpm: 0.7 - 2 bar
	1100 rpm: 2.1 - 3bar
	Max speed: 6 bar
Engine brake	30 kW/lt (2400 rpm)
Torque per unit liter	181 Nm
PS per unit liter	36 PS

# TECHNICAL SPECIFICATIONS

## Transmission Specifications

### Gearbox gear ratios

16 S2600 AMT OD & 16 S 2600 MT OD					
	LOW	HIGH		LOW	HIGH
1ST GEAR	14,11	11,61	5TH GEAR	3,12	2,57
2ND GEAR	9,86	8,11	6TH GEAR	2,18	1,79
3RD GEAR	6,61	5,44	7TH GEAR	1,46	1,2
4TH GEAR	4,52	3,54	8TH GEAR	1	0,82
			REVERSE GEAR 1	-12,54	-10,32
			REVERSE GEAR 2	-2,77	-2,28

ZF 12 TX 2620 AMT					
	LOW	HIGH		LOW	HIGH
1ST GEAR	16.688	12.924	5TH GEAR	2.174	1.684
2ND GEAR	9.926	7.688	6TH GEAR	1.291	1
3RD GEAR	5.895	4.565	REVERSE GEAR	15.537	12.033
4TH GEAR	3.655	2.831			

ZF 16S 2530					
	LOW	HIGH		LOW	HIGH
1ST GEAR	13.8	11.54	6TH GEAR	2.08	1.74
2ND GEAR	9.49	7.93	7TH GEAR	1.43	1.2
3RD GEAR	6.53	5.46	8TH GEAR	1	0.84
4TH GEAR	4.57	3.82	REVERSE GEAR	12.92	10.8
5TH GEAR	3.02	2.53			

16 S2600 AMT DD					
	LOW	HIGH		LOW	HIGH
1ST GEAR	17,03	14,11	5TH GEAR	3,77	3,12
2ND GEAR	11,90	9,86	6TH GEAR	2,63	2,18
3RD GEAR	7,98	6,61	7TH GEAR	1,76	1,46
4TH GEAR	5,46	4,52	8TH GEAR	1,21	1
			REVERSE GEAR 1	-15,14	-12,54
			REVERSE GEAR 2	-3,35	-2,77

ZF 12 TX 2210 TD AMT					
	LOW	HIGH		LOW	HIGH
1ST GEAR	16.688	12.924	5TH GEAR	2.174	1.684
2ND GEAR	9.926	7.688	6TH GEAR	1.291	1
3RD GEAR	5.895	4.565	REVERSE GEAR	15.537	12.033
4TH GEAR	3.655	2.831			

# TECHNICAL SPECIFICATIONS

## Transmission Specifications

### Gearbox gear ratios

#### ZF 9AS 1510 ECOTRONIC

1ST GEAR	9,48	6TH GEAR	1,89
2ND GEAR	6,58	7TH GEAR	1,35
3RD GEAR	4,68	8TH GEAR	1
4TH GEAR	3,48	9TH GEAR	0,75
5TH GEAR	2,62	REVERSE GEAR	8,97

#### Eaton ESO 14409

1ST GEAR	6.55	6TH GEAR	1.38
2ND GEAR	4.87	7TH GEAR	1
3RD GEAR	3.53	8TH GEAR	0.75
4TH GEAR	2.64	REVERSE GEAR	9.83
5TH GEAR	1.86	C GEAR	9.40

#### ZF 16S 1630

	LOW	HIGH		LOW	HIGH
1ST GEAR	16.41	13.8	6TH GEAR	2.47	2.08
2ND GEAR	11.28	9.49	7TH GEAR	1.7	1.43
3RD GEAR	7.76	6.53	8TH GEAR	1.19	1
4TH GEAR	5.43	4.57	REVERSE GEAR	15,36	12,92
5TH GEAR	3.59	3.02			

#### ZF 16S 2230

	LOW	HIGH		LOW	HIGH
1ST GEAR	13.8	11.54	6TH GEAR	2.08	1.74
2ND GEAR	9.49	7.93	7TH GEAR	1.43	1.2
3RD GEAR	6.53	5.46	8TH GEAR	1	0.84
4TH GEAR	4.57	3.82	REVERSE GEAR	12.92	10.8
5TH GEAR	3.02	2.53			

# TECHNICAL SPECIFICATIONS

## Installation of Upper structure

You can access the web portal designed to be a guide for Ford Trucks upper structure manufacturers from the following address:  
<https://www.fordtrucksbodybuilderportal.com>

Portal requires a membership and provides the following:

- Urgent info bulletins
- Superstructure forms
- Technical bulletins
- Type approvals
- 2D and 3D technical drawings and models
- Vehicle specification sheets
- Electric and air outlet diagrams
- Advisory, monitory documents

- List of superstructure builders listed as recommended firm as per the inspections of Ford Otosan.

Visit

<https://www.fordtrucksbodybuilderportal.com>  
“Ford Otosan contact information” tab to contact relevant persons for your questions.

You may send e-mails to [gvmhelp@ford.com.tr](mailto:gvmhelp@ford.com.tr) for your questions on the portal.

# AUXILIARY HEATER

## Airtronic/Airtronic M

### Special text structure, presentation and picture symbols

This manual uses special text structures and picture symbols to emphasise different contents. Please refer to the examples below for the corresponding meanings and associated actions.

### Special structure and presentations

A dot (·) indicates a list which is started by a heading. If an indented dash (–) follows a dot, this list is subordinate to the dot.

### Picture symbols



#### REGULATION!

This picture symbol with the remark "Regulation" refers to a statutory regulation. Failure to comply with this regulation results in expiry of the type permit for the heater and preclusion of any guarantee and liability claims on Eberspächer Climate Control Systems GmbH and its associated companies.



#### DANGER!

This picture symbol with the remark

"Danger!" refers to the risk of a fatal danger to life and limb. Under certain circumstances, failure to comply with these instructions can result in severe or life-threatening injuries



#### CAUTION!

This picture symbol with the remark "Caution!" refers to a dangerous situation for a person and / or the product. Failure to comply with these instructions can result in injuries to people and / or damage to machinery.



#### Please note!

These remarks contain application recommendations and useful tips for installation of the heater.

Important information before starting work

### Range of application of the heater

The air heater operating independently of an engine is intended for installation in the following vehicles, depending on its heating output:

- All types of vehicles (max. 8 seats + driver's seat) and their trailers
- Construction machinery

- Agricultural machinery
- Boats, ships and yachts (only diesel heaters)
- Camper vans



#### Please note!

- The heaters (only diesel heaters, 24 volt) can be installed in vehicles used for the transport of dangerous goods as per ADR.
- The current controller is to be replaced by a special controller when the heater is to be used to heat the freight compartment / cargo (order no. see heater price list or spare parts list).
- The „Plus“ installation kits are intended for installation in a camper van.

### Purpose of the heater

- Pre-heating, de-misting windows
- Heating and keeping the following warm:
  - Driver and working cabs, Ship's cabins
  - Freight compartments
  - Passenger and crew compartments
  - Camper vans

On account of its functional purpose, the heater is not permitted for the following applications: for the following applications:

- Long-term continuous operation, e.g. for preheating and heating of
  - Residential rooms
  - Garages



# AUXILIARY HEATER

## Airtronic/Airtronic M

- Work huts, weekend homes and hunting huts
- Houseboats, etc.
- Heating or drying:
- Living creatures (people or animals) by blowing hot air directly at the subject
- Objects
- Blowing hot air into containers





### CAUTION!

### Safety instructions for application and proper purpose

- The heater must only be used and operated for the range of application stated by the manufacturer in compliance with the "Operating instructions" included with every heater.

### Statutory regulations

The Federal Motor Transport Authority has issued an approval for a component according to ECE R122 and ECE-R10 for the heater for installation in motor vehicles, with the following official typeapproval markings noted on the heater's nameplate.

Heater type:	ECE type approval mark:
Airtronic	 122 R – 000025 10 R – 051516
Airtronic M	 122 R – 000026 10 R – 051653



### REGULATION!

### Excerpt from ECE regulation No. 122 of the European Parliament and the Council

#### General regulations

##### • Operating state display

- A clearly visible operating display in the user's field of vision must indicate when the heater is switched on and off.

##### Regulations concerning installation in the vehicle

##### • Scope

- Subject to differing stipulations in the following section, combustion heaters must be installed according to the regulations 5.3 of ECE-R122.
- It is assumed that Class O vehicles with heaters for liquid fuel conform to the regulations 5.3 of ECE-R122.

##### • Arrangement of the heater

- Parts of the structure and other components near the heater must be protected from excessive heat exposure and possible fuel or oil contamination.
- The heater must not pose a fire hazard even when it over-heats. This requirement is deemed to be fulfilled if adequate clearance is ensured for all parts during installation, sufficient ventilation is provided and fireproof materials or heat shields are used.
- The heater must not be mounted in the passenger compartment of vehicles in class M<sub>2</sub> and M<sub>3</sub>. However, a heater in a hermetically sealed enclosure which also complies with the aforementioned conditions may be used.
- The factory nameplate or duplicate must be affixed so that it can still be easily read when the heater is installed in the vehicle.
- All appropriate precautions must be taken when arranging the heater to minimise the risk of injuries to persons or damage to other property.
- Fuel supply
  - The fuel intake connection must not be located in the passenger compartment and must be sealed with a properly

# AUXILIARY HEATER

## Airtronic/Airtronic M

- closing lid to prevent any fuel leaks.
- In heaters for liquid fuel where the heater fuel is separate from the vehicle fuel, the type of fuel and intake connection must be clearly identified.
- A warning sign is to be fixed to the intake connection indicating that the heater must be switched off before refuelling.
- **Exhaust system**
  - The exhaust outlet must be arranged so as to prevent any penetration of exhaust fumes into the vehicle interior through the ventilation system, warm air intakes or open windows.
- **Combustion air intake**
  - The air for the heater's combustion chamber must not be sucked in from the vehicle's passenger compartment.
  - The air intake must be arranged or protected in such a way that it cannot be blocked by other objects.
- **Hot air intake**
  - The heater's air supply must consist of fresh air or circulated air and must be sucked in from a clean area, which cannot be contaminated by exhaust fumes from the engine, the combustion heater or any other source in the vehicle.
  - The intake pipe must be protected by a grid or other suitable means.
- **Hot air outlet**
  - The hot air pipes within the vehicle must be arranged or protected in such a way that there is no risk of injury or damage if they are touched.
  - The air outlet must be arranged or protected in such a way that it cannot be blocked by any objects.
- **Automatic control of the heating system**
  - If the engine fails, the heating system must be automatically switched off and the fuel supply stopped within 5 seconds. The heater may remain in operation if a manual device has already been activated.

### § STATUTORY REGULATIONS!

#### **Additional regulations for certain vehicles named in Directive 94/55/EC of the ADR Agreement**

##### **Scope**

This appendix applies to vehicles for which the special provisions of Directive 94/55/EC apply to combustion heaters and their installation.

##### **Definition of terms used**

The vehicle designations "EX / II", "EX / III", "AT", "FL" and "OX" according to Chapter 9.1 of the ADR Agreement Directive 94/55/EC are used for the purposes of this annex.

##### **Technical regulations**

##### **General provisions (EX / II, EX / III, AT, FL and OX vehicles)**

##### **Avoid heating and ignition**

Combustion heaters and their exhaust pipes must be designed, arranged, protected or covered so that any unacceptable risk of heating or ignition of the load is avoided. This regulation is deemed to be complied with if the fuel tank and the exhaust system of the unit conform to the regulations described in the "Fuel tank" and "Exhaust system and exhaust pipe layout" paragraphs. The complete vehicle must be checked for compliance with these regulations.

##### **Fuel tanks**

Fuel tanks for supplying the heater shall conform to the following regulations:

- In the event of any leakage, the fuel shall

# AUXILIARY HEATER

## Airtronic/Airtronic M

- drain to the ground without coming into contact with hot parts of the vehicle or the load;
- fuel tanks containing petrol shall be equipped with an effective flame trap at the filler opening or with a closure enabling the opening to be kept hermetically sealed.

### Exhaust system and exhaust pipe layout

The exhaust system as well as the exhaust pipes shall laid out or protected to avoid any danger to the load through heating or ignition. Parts of the exhaust system situated directly below the fuel tank (diesel) shall have a clearance of at least 100 mm or be protected by a thermal shield. Switching on the combustion heater The combustion heater may only be switched on manually. Automatic switching on via a programmable switch is not permitted.

### EX / II and EX / III vehicles

Combustion heaters for gaseous fuels are not permitted.

### FL vehicles

Combustion heaters must be able to be

taken out of service/disabled at least by the methods described in the following:

- a) Switching off manually in the driver's cabin
- b) Switching off the vehicle's engine; in this case the heater may be manually switched back on by the vehicle driver;
- c) Starting up of a feed pump installed in the vehicle for the dangerous goods carried. Combustion heater after-run After-running of the switched off combustion heater is permitted. In the cases named in the „FL vehicles“ paragraph under letters b) and c) the supply of combustion air must be interrupted by suitable means after a maximum after-run period of 40 seconds. Only combustion heaters whose heat exchangers are verifiably not damaged by the reduced after-run period of 40 seconds beyond their usual use period may be used.



### Please note!

- Compliance with the statutory regulations, the additional regulations and safety instructions is prerequisite for guarantee and liability claims. Failure to

comply with the statutory regulations and safety instructions and incorrect repairs even when using original spare parts make the guarantee null and void and preclude any liability for Eberspächer Climate Control Systems GmbH.

- Subsequent installation of this heater must comply with these installation instructions.
- The statutory regulations are binding and must also be observed in countries which do not have any special regulations.
- When the heater is to be installed in vehicles not subject to the German Ordinance for the Registration of Motor Vehicles (StVZO), for example ships, the specially valid regulations and installation instructions for these special applications must be observed.
- Installation of the heater in special vehicles must comply with the regulations applying to such vehicles
- Other installation requirements are contained in the corresponding sections of this manual.

# AUXILIARY HEATER

## Airtronic/Airtronic M

### Safety instructions for installation and operation



#### **DANGER!**

#### **Risk of injury, fire and poisoning!**

- The heater must only be started up when the maintenance flap is closed and the outlet hood is mounted in position.
- The maintenance flap must not be opened during operation.
- Disconnect the vehicle battery before commencing any kind of work.
- Before working on the heater, switch the heater off and let all hot parts cool down.
- The heater must not be operated in closed rooms, e.g. in the garage or in a multi-storey car park.
- Adjustable hot air outlets must always be adjusted so that they cannot blow hot air directly at living creatures (people, animals) or objects sensitive to temperature (loose and / or fastened).



#### **CAUTION!**

### Safety instructions for installation and operation!

- The year of initial commissioning must be marked on the nameplate.
- The heat exchanger of air heaters is a component subject to high thermal loads which must be replaced 10 years after initial commissioning of the heater. In addition, the installation date must be entered on the plate "original spare part" enclosed with the heat exchanger must. Then affix the plate next to the nameplate on the heater.
- The heater must only be installed by a JE partner authorised by the manufacturer according to the instructions in this manual and possibly according to special installation recommendations; the same applies to any repairs to be carried out in the case of repairs or guarantee claims.
- Only the control elements approved by Eberspächer Climate Control Systems GmbH. must be used to operate the heater. The use of other control elements can cause malfunctions.
- Repairs by unauthorised third-parties or with not original spare parts are dangerous and therefore not allowed. They result in expiry of the type permit of the heater; consequently, when installed in motor vehicles they can cause expiry of the vehicle operating licence.
- The following measures are not allowed:
  - Changes to components relevant to the heater.
  - Use of third-party components not approved by Eberspächer.
- Nonconformities in installation or operation from the statutory regulations, safety instructions or specifications relevant to safe operation as stated in the installation instructions 1 Introduction and operating instructions. This applies in particular to the electrical wiring, fuel supply, combustion air system and exhaust system.
- Only original accessories and original spare parts must be used during installation or repairs.
- When carrying out electric welding on the vehicle, the plus pole cable at the battery should be disconnected and placed at ground to protect the controller.
- Do not operate the heater anywhere where there are readily flammable materials (e.g. dry grass, leaves, paper, etc.) in the area of the exhaust system or where ignitable fumes and dust can form, e.g. near a
  - fuel depot
  - coal depot
  - wood depot
  - grain depots, etc.
- The heater must be switched off when refuelling.
- When the heater is mounted in a safety housing etc., the installation compartment of the heater is not a

# AUXILIARY HEATER

## Airtronic/Airtronic M

- stowage compartment and must be kept clear. In particular fuel canisters, oil cans, spray cans, gas cartridges, fire extinguishers, cleaning rags, items of clothing, paper etc. must not be stored or transported on or next to the heater.
- Defect fuses must only be replaced by fuses with the prescribed rating.
- If fuel leaks from the heater fuel system, arrange for the damage to be repaired immediately by a JE service partner.
- After-running of the heater must not be interrupted prematurely e.g. by pressing the battery disconnecting switch, apart from in the case of an emergency stop.



### Please note!

Following installation, attach the „Switch off heater before refuelling!“ sticker near the tank filler neck.

### Accident prevention

General accident prevention regulations and the corresponding workshop and operation safety instructions are to be observed.

# AUXILIARY HEATER

## Airtronic/Airtronic M

### Heater scope of supply, complete packages and universal installation kit

Heater	Order No
Airtronic D2, 12 V	25 2069 05 00 00
Airtronic D2, 24 V	25 2070 05 00 00
Airtronic B3 Plus, 12 V	20 1944 05 00 00
Airtronic D3, 12 V	25 2317 05 00 00
Airtronic B4, 12 V	20 1812 05 00 00
Airtronic D4, 12 V	25 2113 05 00 00
Airtronic D4, 24 V	25 2114 05 00 00
Airtronic D4 Plus, 12 V	25 2484 05 00 00
Airtronic D4 Plus, 24 V	25 2498 05 00 00

The scope of supply includes:

Figure No	Name
1	Heater
2	Metering pump

### Complete Airtronic D2 Order No. package

Order No.
12 V with EasyStart Select
25 2675 05 00 00
24 V with EasyStart Select
25 2676 05 00 00

Included in the scope of supply:

Figure No	Name
1	Heater
2	Metering pump
-	Installation kit with outlet hood Ø 60 mm
3	EasyStart Select
4	Tank connection (only in complete package Airtronic D2, 24 V)

Universal installation kit (all versions)

Included in the scope of supply:

Figure No	Name
5	Lead harness, plus / minus (included in Item 22)
6	Lead harness, operation (included in Item 22)
7	Flexible exhaust pipe, 1 m long
8	Combustion air hose, 1 m long
9	Cable tie (2x10)
	Bracket, metering pump
11	Pipe, 6 x 2, 1.5 m long
12	Pipe, 4 x 1.25, 7.5 m long
13	Hose clip (1x)
14	Air outlet 30°, Ø 75 mm / Ø 90 mm
15	Connection socket, Ø 75 mm / Ø 90 mm
16	Air outlet, upward 30°, Ø 60 mm

# AUXILIARY HEATER

## Airtronic/Airtronic M

17	Connection socket Ø 60 mm
18	Grid
19	Hood
20	Flexible pipe
21	Exhaust silencer
22	Cable harness, heater

Using the universal installation kits

Order No.

### Universal installation kit 25 2069 80 00 00

- with outlet hood Ø 60 mm, heater guide number 6, usable with:
  - Airtronic D2, 12 V 25 2069 05 00 00
  - Airtronic D2, 24 V 25 2070 05 00 00

### Universal installation kit 25 2113 80 00 00

- with outlet hood Ø 90 mm, heater guide number 10, usable with:

- Airtronic D3, 12 V 25 2317 05 00 00
- Airtronic B4, 12 V 20 1812 05 00 00
- Airtronic D4, 12 V 25 2113 05 00 00
- Airtronic D4, 24 V 25 2114 05 00 00

- with outlet hood Ø 90 mm, heater guide number 15, usable with:

- Airtronic D4 Plus, 12 V 25 2484 05 00 00
- Airtronic D4 Plus, 24 V 25 2498 05 00 00
- with outlet hood Ø 90 mm, heater guide number 30, usable with:
  - Airtronic B3 Plus, 12 V 20 1944 05 00 00

### Universal installation kit 25 2484 80 00 00

- with outlet hood Ø 75 mm, heater guide number 3, usable with:
  - Airtronic D3, 12 V 25 2317 05 00 00
  - Airtronic B4, 12 V 20 1812 05 00 00
  - Airtronic D4, 12 V 25 2113 05 00 00
  - Airtronic D4, 24 V 25 2114 05 00 00

- with outlet hood Ø 75 mm, heater guide number 8, for recirculation mode heater guide number 10, for fresh air mode usable with:
  - Airtronic B3 Plus, 12 V 20 1944 05 00 00
  - Airtronic D4 Plus, 12 V 25 2484 05 00 00
  - Airtronic D4 Plus, 24 V 25 2498 05 00 00



### Please note!

- Control elements see price list or product information.
- Parts without a figure no. are small parts and packed in a bag.
- If other parts are required for the installation, see product information.
- For notes on the unit ratings, refer to product information

# AUXILIARY HEATER

## Airtronic/Airtronic M

Scope of supply: Heater, universal installation kit and complete packages

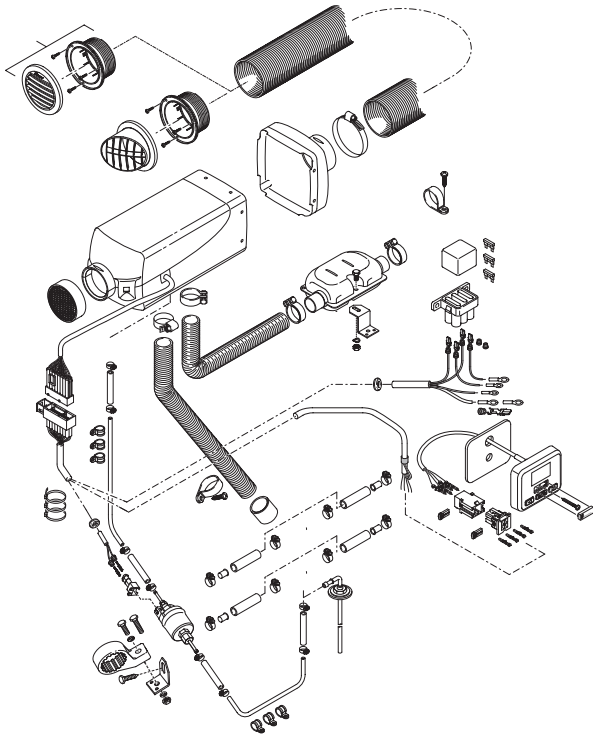

- \* Only included in the complete Airtronic D2 package.
- \*\* Only included in the complete Airtronic D2, 24 volt package.
- \*\*\* Only included in the installation kit for the Airtronic D2 and in the complete Airtronic D2 package.
- \*\*\*\* Only included in the installation kit for the Airtronic B3 Plus, D3, B4, D4, D4 Plus.



# AUXILIARY HEATER

## Airtronic/Airtronic M

### Scope of supply Heater and "Plus" installation kit

Heater	Order No
Airtronic D2, 12 V	25 2069 05 00 00
Airtronic D2, 24 V	25 2070 05 00 00

The scope of supply includes:

Figure No.	Name
1	Heater
2	Metering pump
"Plus" installation kit	25 2113 82 00 00

- with outlet hood Ø 75 mm, heater guide number 12,

The scope of supply includes:

Figure No.	Name
3	Combustion air intake silencer
4	Exhaust silencer
5	Connection socket, Ø 60 mm (3x)

6	Air outlet 0°, Ø 60 mm	20	Bracket metering pump
7	Y-pipe Ø 75/60/60 mm	21	Cable tie (2x10)
8	Tank connection kit	22	Hood Ø 75 mm
9	Temperature control sensor	23	Air outlet 30°, Ø 60 mm
10	Cable loom for temperature control sensor	24	Adapter Ø 6 / 4
11	Flexible tubing, Ø 75 mm (is not supplied)	25	Pipe 4 x 1, 6 m long, (included in Item 8)
12	Lead harness, plus / minus (included in Item 17)	26	Pipe clip, Ø 50 mm
13	Lead harness, operation (included in Item 17)	27	Flexible pipe Ø 60 mm for hot air system (is not supplied)
14	Hose clip Ø 60 mm (2x)		
15	Hose clip Ø 75 mm (2x)		
16	Pipe 4 x 1.25 , 6 m long, (included in Item 8)		
17	Cable harness, heater		
18	Flexible exhaust pipe, 1 m long		
19	Grid		



### Please note!

- Parts without a figure no. are small parts and packed in a bag.
- If other parts are required for the installation, see product information.
- For notes on the unit ratings, refer to product information.
- The "Plus" installation kits are particularly suitable for installations in camper vans and boats.

# AUXILIARY HEATER

## Airtronic/Airtronic M

Scope of supply: Heater and “Plus”  
installation kit

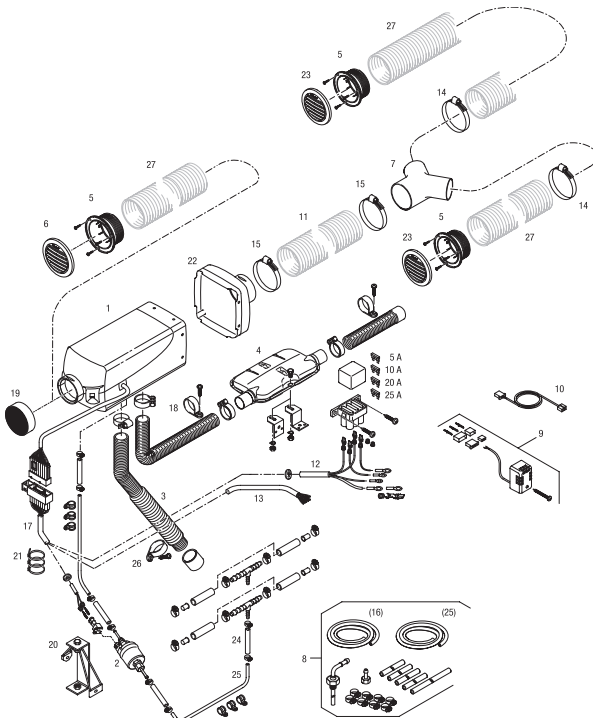

# AUXILIARY HEATER

## Airtronic/Airtronic M

### Technical data

Heater type	Airtronic					
Heater	Airtronic D2					
Version	D2					
Heating medium	Air					
Control of the heat flow	Stage					
	Power	Large	Medium	Small	Off	
Heat flow (watt)	2200	1800	1200	850	–	
Heater air flow rate without counterpressure (kg/h)	with hood Ø 60 mm	105	87	60	42	13
Fuel consumption (l/h)		0,28	0,23	0,15	0,10	–
Elektr. power consumption (watt)	in operation	34	23	12	8	4
		at start	≤100			
Rated voltage	12 or 24 volt					
Operating range • Lower voltage limit: An undervoltage protection in the controller switches off the heater when the voltage limit is reached.	approx. 10.5 volt resp. 21 volt Undervoltage protection trigger time: 20 seconds					

# AUXILIARY HEATER

## Airtronic/Airtronic M

<ul style="list-style-type: none"> <li>Upper voltage limit: An overvoltage protection in the controller switches off the heater when the voltage limit is reached.</li> </ul>	approx. 16 volt resp. 32 volt Overvoltage protection trigger time: 20 seconds	
Fuel "Fuel quality" and "Fuel at low temperatures" see page 28.	Commercially available diesel fuel (DIN EN 590)	
Tolerable ambient temperature	Operation	Not running
	Heater	- 40 °C to +70 °C
Dosing pump	- 40 °C to +50 °C	- 40 °C to +125 °C
Maximum air intake temperature	+40 °C	
Interference suppression	Interference suppression class 5 to DIN EN 55 025	
Weight	approx. 2,7 kg	
Ventilation mode	possible	



### CAUTION!

Safety instructions for technical data!  
Failure to comply with the technical data can result in malfunctions.



### Please note!

Provided no limit values are given, the technical data listed is subject to the tolerances usually applicable to heaters of  $\pm 10\%$  for nominal voltage, ambient temperature 20 °C and reference altitude Esslingen.

# AUXILIARY HEATER

## Airtronic/Airtronic M

### Technical data

Heater type		Airtronic M				
Heater		Airtronic D3 / Airtronic D4 / Airtronic D4 Plus				
Version		D3 / D4 / D4 Plus				
Heating medium		Air				
Control of the heat flow		Stage				
		Power	Large	Medium	Small	Off
Heater air flow rate without counterpressure (kg/h)	D3	3000	2200	1600	900	–
	D4	4000	3000	2000	900	–
	D4 Plus	4000	3000	2000	900	–
Heater air flow rate without counterpressure (kg/h)	D3 with hood Ø 90 mm	150	120	90	60	24
	D4 with hood Ø 90 mm	185	150	110	60	22
	D4 Plus with hood Ø 75 mm	185	140	100	55	–
Fuel consumption (l/h)	D3	0,38	0,28	0,24	0,11	–
	D4	0,51	0,38	0,25	0,11	–
	D4 Plus	0,51	0,38	0,25	0,11	–
Elektr. power consumption (watt) in operation (12 and 24 volt)	D3	24	16	10	7	5
	D4	40	24	13	7	5
	D4 Plus	55	30	16	7	5
at start (12 and 24 volt)		≤100				

# AUXILIARY HEATER

## Airtronic/Airtronic M

Rated voltage	12 or 24 volt	
Operating range · Lower voltage limit: An undervoltage protection in the controller switches off the heater when the voltage limit is reached.	approx. 10.5 volt resp. 21 volt Undervoltage protection trigger time: 20 seconds	
· Upper voltage limit: An overvoltage protection in the controller switches off the heater when the voltage limit is reached.	approx. 16 volt resp. 32 volt Overvoltage protection trigger time: 20 seconds	
Fuel "Fuel quality" and "Fuel at low temperatures" see page 28.	Commercially available diesel fuel (DIN EN 590)	
Tolerable ambient temperature	Operation	Not running
Heater	- 40 °C to +70 °C	- 40 °C to +85 °C
Dosing pump	- 40 °C to +50 °C	- 40 °C to +125 °C
Maximum air intake temperature	+40 °C	
Interference suppression	Interference suppression class 5 to DIN EN 55 025	
Weight	approx. 4,5 kg	
Ventilation mode	possible	



**Please note!**

Safety instructions for technical data see page 12.

# AUXILIARY HEATER

## Airtronic/Airtronic M

### Technical data

Heatertyp		Airtronic M				
		Airtronic B3 Plus / Airtronic B4				
Heater		Airtronic B3 Plus / Airtronic B4				
Version		B3 Plus / B4				
Heating medium		Air				
Control of the heat flow		Stage				
		Power	Large	Medium	Small	Off
Heat flow (watt)	B3 Plus	3000	2300	1700	1200	–
	B4	3800	3200	2100	1300	–
Heater air flow rate without counterpressure (kg/h)						
	B3 Plus with hood Ø 90 mm	175	143	115	85	24
	B4 with hood Ø 90 mm	185	160	120	85	24
Fuel consumption (l/h)	B3 Plus	0,43	0,33	0,24	0,16	–
	B4	0,54	0,46	0,29	0,18	–
Elektr. power consumption (watt) iin operatioint (12 and 24 volt)	B3 Plus	33	20	13	8	5
	B4	40	29	15	9	5
	at start	≤100				

# AUXILIARY HEATER

## Airtronic/Airtronic M

Rated voltage	12 volt	
Operating range · Lower voltage limit: An undervoltage protection in the controller switches off the heater when the voltage limit is reached.	approx. 10.5 volt Undervoltage protection trigger time: 20 seconds	
· Upper voltage limit: An overvoltage protection in the controller switches off the heater when the voltage limit is reached.	approx. 16 volt Undervoltage protection trigger time: 20 seconds	
Fuel "Fuel quality" and "Fuel at low temperatures" see page 28.	Commercially available petrol fuel (DIN EN 228)	
Tolerable ambient temperature	Operation	Not running
	Heater	- 40 °C to +50 °C
	Dosing pump	- 40 °C to +125 °C
Maximum air intake temperature	+40 °C	
Interference suppression	Interference suppression class 5 to DIN EN 55 025	
Weight	approx. 4,5 kg	
Ventilation mode	possible	



**CAUTION!**

### Safety instructions for technical data!

Failure to comply with the technical data can result in malfunctions.



**Please note!**

Provided no limit values are given, the technical data listed is subject to the tolerances usually applicable to heaters of  $\pm 10\%$  for nominal voltage, ambient temperature 20 °C and reference altitude Esslingen.



# AUXILIARY HEATER

## Airtronic/Airtronic M

### Main dimensions Airtronic

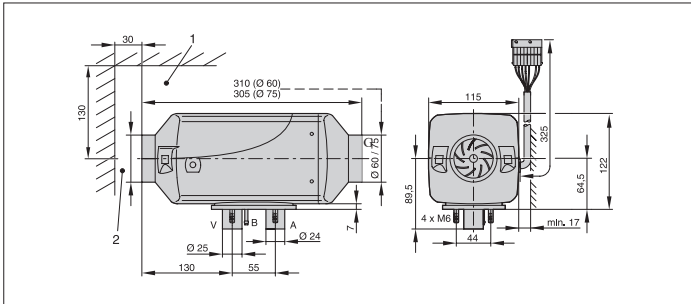

### Main dimensions Airtronic M

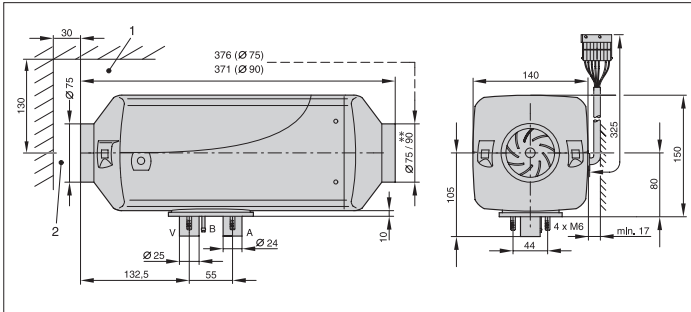

1. Minimum installation clearance (space) for opening the lid and for dismantling the glow plug and the controller.
  2. Minimum installation clearance (space) for intake of heater air.
- A = Exhaust  
B = Fuel  
V = Combustion air

\* Outlet hood for Airtronic D2:

- Ø 60 mm, included in the universal installation kit - Ø 75 mm, included in the "Plus" installation kit

\*\* Outlet hood for Airtronic B3 Plus, D3, B4, D4:

- Ø 75 mm, included in the universal installation kit
- Ø 90 mm, included in the universal installation kit or in the "Plus" installation kit

Outlet hood for Airtronic D4 Plus:

- Ø 75 mm, included in the universal installation kit or in the "Plus" installation kit
- Ø 90 mm, included in the universal installation kit or in the "Plus" installation kit



### Please note!

Installation of spherical reduction hood is not permitted in the Airtronic D4 Plus.

# AUXILIARY HEATER

## Airtronic/Airtronic M

### Nameplate

The nameplate is fastened to the front of the heater. The second nameplate (duplicate) is included in the scope of supply of the heater.

If required, the duplicate nameplate can be adhered in a clearly visible position on the heater or near to the heater.



### Please note!

The regulations and safety instructions to be observed for this chapter are stated on page 5.

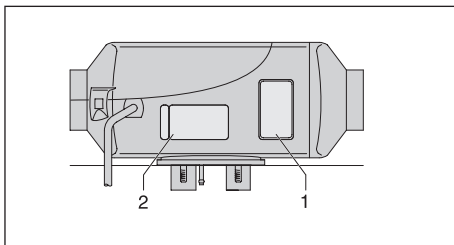

- 1 Original nameplate
- 2 2nd nameplate (duplicate)

### Installation and mounting position

The heater is suitable and approved for installation in vehicle interiors used by people.

The heater, together with its heater angle and the mounted angle seal, is fixed directly onto the floor of the vehicle or in a suitable position in the rear panel of the vehicle.



### Please note!

- If installed inside the vehicle, detachable connections of exhaust gas, combustion air and fuel lines are not allowed.
- The angle seal must be mounted on the heater, in order to seal off the openings for the exhaust gas, combustion air and fuel lines.
- Installation in the driver's cab or passenger compartment of commercial buses with more than 9 seats (8 seats + driver's seat) is not allowed.
- The ADR regulations must also be complied with for installation of the heater in vehicles used to transport dangerous goods. For information on the ADR regulations, see page 6, 31 and in the information sheet with Print No. 25 2161 95 15 80.
- When installing the heater, ensure sufficient open space is allowed for intake of the heating air and for the dismantling of glow plugs and control box (see page

15 "main dimensions").

- Observe the regulations and safety instructions for this chapter, given on pages 4 – 7.

### Installation position in a camper van

In a camper van, the heater is preferably installed in the inner compartment or luggage compartment.

If it is not possible to install the heater in the passenger compartment or boot, the heater can also be mounted, protected against splashing water, under the vehicle floor.



### Please note!

The „Plus“ installation kits are intended for installation in a camper van.

# AUXILIARY HEATER

## Airtronic/Airtronic M

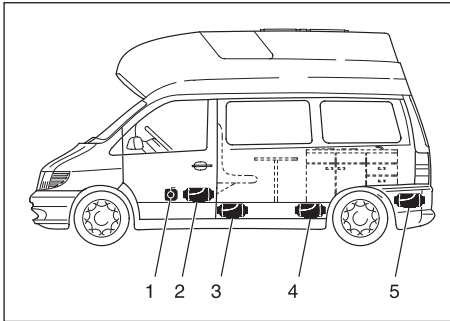

1. Heater in front of the passenger seat
2. Heater between the driver's seat and the passenger seat
3. Heater under the vehicle door
4. Heater in living space
5. Heater in the boot

### Installation

Installation in a car or people carrier  
In a car or people carrier, the heater is preferably installed in the passenger compartment or boot.

If it is not possible to install the heater in the passenger compartment or boot, the heater can also be mounted, protected against splashing water, under the vehicle door.

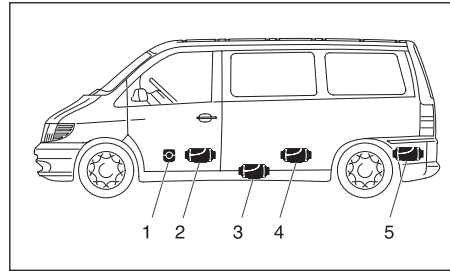

1. Heater in front of the passenger seat
2. Heater between the driver's seat and the passenger seat
3. Heater under the vehicle door
4. Heater under the back seat
5. Heater in the boot

### Installation in an excavator cab (only diesel heaters)

In an excavator, the heater is preferably installed in the cab. If it is not possible to install the heater in the cab, the heater can also be installed in a storage box outside the cab.

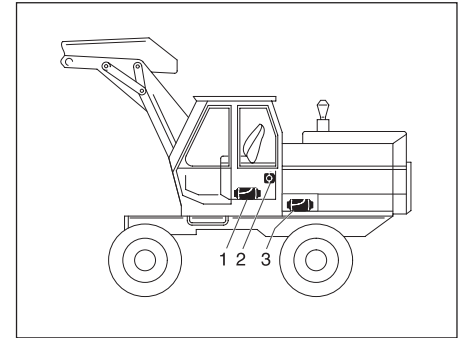

- 1 Heater in the seat box
- 2 Heater on the cab rear wall
- 3 Heater in a protective case

# AUXILIARY HEATER

## Airtronic/Airtronic M

### Installation in a truck (only diesel heaters)

In a truck, the heater is preferably installed inside the driver's cab. If it is not possible to install the heater inside the driver's cab, it can also be mounted in the tool box or in a storage box.

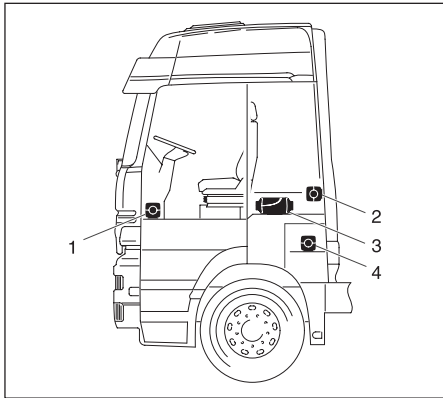

1. Heater in the passenger's foot room
2. Heater on the cab rear wall
3. Heater under the bed
4. Heater in the tool box



### Please note!

- The installation suggestions made in the installation instructions are just examples. Other installation locations are possible, as long as they correspond to the installation requirements stated in these instructions.
- Other installation information (e.g. for boats and ships) is available from the manufacturer on request.
- Observe the tolerable installation position together with the operating and storage temperatures.

### Possible installation positions

The heater is preferably installed in the normal position as shown in the drawing. Depending on the installation conditions, the heater can be tilted by max. 30° (down direction to the bottom) or turned by max. 90° around its own longitudinal axis (exhaust connection horizontal, glow plug points upwards!).



### Please note!

In the heating mode, the heater can deviate from the shown normal or maximum installation positions by up to

+15° in all directions because of a slanting position of the vehicle or boat, without any impaired functions.

# AUXILIARY HEATER

## Airtronic/Airtronic M

**Normal position horizontal (exhaust connection downwards)  
with tolerable swivel range**

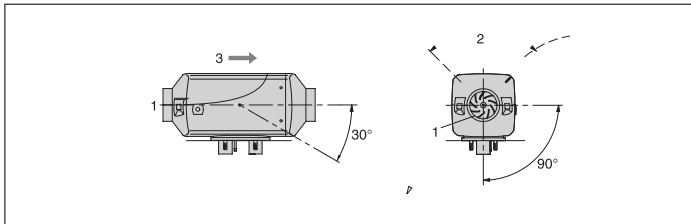

- 1 Heater air intake opening (fan wheel)
- 2 Position of the glow plug
- 3 Direction of flow

### **Cable harness connection, optionally right or left**

If necessary, the cable harness connection can be changed over to the other side of the heater. To do so, the controller has to be removed and the lower semi-circular cable harness cover unclipped.

The cable harness can then be rerouted in the controller.

Then mount the controller again, position the jacket shell and insert the cable harness bush and the bungs in the corresponding recesses in the lower jacket shell.

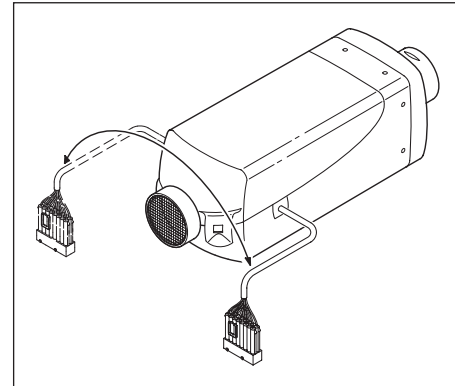

# AUXILIARY HEATER

## Airtronic/Airtronic M

### Mounting and fastening

Make the necessary breakthroughs for exhaust, combustion air and fuel as shown in the hole diagram. The support surface for the heater foot must be at. An appropriate tool can be purchased from the manufacturer for drilling the breakthroughs and also smoothing the support surface. The hole  $\varnothing 10.5$  mm for the cable harness "dosing pump" is not included in the picture drawing and must be drilled after installation.

### Picture hole

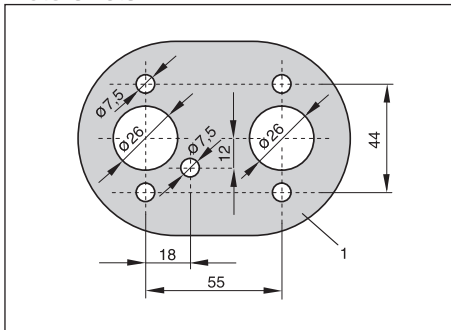

1 Contour of the bearing surface

If the sheet metal of the support surface is  $<1.5$  mm thick, an additional reinforcement must be installed.

Order no: 20 1577 89 00 03  
reinforcement plate

Order no: special tool 99 1201 46 53 29

### Special tool

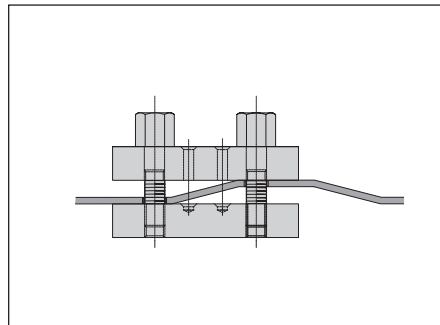

# AUXILIARY HEATER

## Airtronic/Airtronic M

### Fastening the unit on the vehicle floor

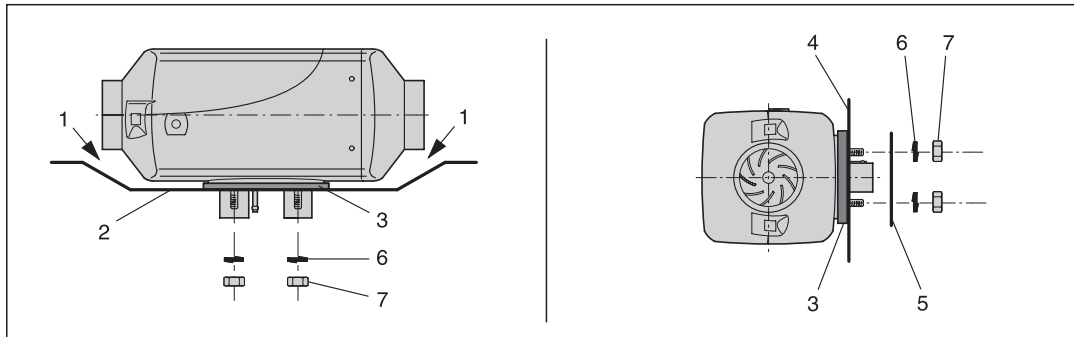

### Fastening the heater horizontally to the vehicle wall

1. There must be sufficient clearance between the heater and the vehicle floor – also check that the fan wheel runs freely.
2. The mounting surface must be flat and smooth.
3. The angle seal must be mounted.

4. The vehicle wall must be flat and smooth.
5. Reinforcement plate (if required, for Order No. see above)
6. Spring washer
7. Hexagon nut M6 (torque 5+1 Nm)

# AUXILIARY HEATER

## Airtronic/Airtronic M

### Heater air system

The parts for the hot air system are included in the scope of supply of the „Universal“ and „Plus“ installation kits. The „Plus“ installation kit does not contain any flexible pipes, these must be ordered separately. Refer to the product information for the Order No.



### **DANGER!**

### Risk of burning and injuries!

- The hoses of the heater air system and the hot air outlet are to be routed and fastened in such a way that they pose no temperature risk to people, animals or materials sensitive to temperature from radiation / contact or blowing directly. If necessary, a cover is to be fitted to the heater air system or hot air outlet.
- The outflow hood must be fitted on the hot air outflow side.
- A safety grid must be fitted to the heater air intake side and outflow side if no air hoses are mounted, to prevent any injuries from the heater air fan or burns from the heat exchanger.
- High temperatures occur in the heater air system during and after the heater has been working. This is why it is important to avoid working in the vicinity of the heater air system while the heater is working. In such cases, switch the

heater off before-hand and wait until all parts have cooled down completely. If necessary, wear safety gloves.



### **Please note!**

- Installation of spherical reduction hood is not permitted in the Airtronic D4 Plus.
- The regulations and safety instructions to be observed for this chapter are on page 4 – 7.
- If air duct parts are connected the heater code number in “Using Universal Installation Kits”, page 8 and “Using Plus Installation Kits”, page 10 must be observed.



### **CAUTION!**

- The heater air intake openings must be arranged in such a way that under normal circumstances, it is not possible for exhaust from the vehicle engine and heater to be sucked into the system, or for the heating air to be contaminated with dust, salt spray, etc.
- For circulating air, position the circulating air intake in such a way that the outflowing hot air cannot be directly sucked in again.
- In the event of possible overheating, it is possible for local hot air temperatures of up to max. 150 °C or surface temperatures of up to max. 90 °C

to occur immediately before the defect shutdown. Therefore only temperature-resistant hot air hoses approved by us must be used for the heater air system!

- When checking the functions, the mean outflow temperature measured after the heater has been running about 10 minutes at approx. 30 cm from the outlet should not exceed 110 °C (at an intake temperature of approx. 20 °C).
- If there is a risk of the driver and passengers touching the heater when the vehicle is being driven normally, a contact protection device must be fitted.



# AUXILIARY HEATER

## Airtronic/Airtronic M

### Hot air system (example)

Some of the parts for the hot air system are included in the scope of supply of the universal installation kit, see page 8.

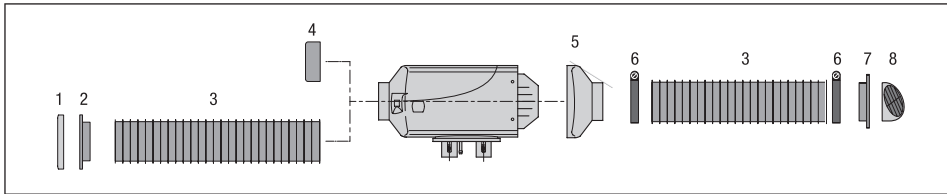

- |                                    |                    |                |                                       |
|------------------------------------|--------------------|----------------|---------------------------------------|
| 1. Safety grille                   | 3. Flexible tubing | 5. Out ow hood | 7. Connection sockets, discharge side |
| 2. Connection sockets, intake side | 4. Safety grille   | 6. Hose clip   | 8. Air outlet, rotatable              |



### Please note!

Observe the regulations and safety instructions for this chapter, given on page 4 to 7. When connecting air system parts, note the heater rating, see page 10. For important information on the air system, the heater guide numbers and the guide numbers for the air system parts, refer to the “Product information” document.

# AUXILIARY HEATER

## Airtronic/Airtronic M

### Installation of pipe connection sockets and air outlets

#### Cutting out the opening for the connection sockets

Use a keyhole saw to cut out an opening for the connection socket at the planned place of installation (vehicle door or wall).

- Pipe connection socket  $\varnothing$  60 mm – keyhole saw  $\varnothing$  68 mm
- Pipe connection socket  $\varnothing$  75 mm /  $\varnothing$  90 mm – keyhole saw  $\varnothing$  92 mm

#### Fixing the pipe connection socket

Insert the pipe connection socket in the drillhole. Mark and drill three fixing holes  $\varnothing$  2 mm.

Use 3 pan-head tapping screws (3.9 x 13) to EN ISO 7049 to fix the connection sockets. Torque max.  $1 \pm 0.5$  Nm.



#### Please note!

Use pan-head screws only to install the connection socket, do not use countersunk head screws.

### Fix air outlet onto the pipe connection socket

Clip the corresponding air outlet onto the pipe connection socket.

### Installing flexible tubing on the pipe connection socket

Turn or latch the flexible tubing onto the thread of the pipe connection socket. It is not necessary to use a hose clip to fix the tubing onto the pipe connection socket.



#### Please note!

- In case of critical installation conditions, we recommend securing the flexible tubing with an additional hose clip at the pipe connection socket.
- Plastic sheathed hot air hoses with wire inlay must be fixed onto the pipe connection socket with a hose clip.
- Tightening torque for hose clip = 3 Nm.

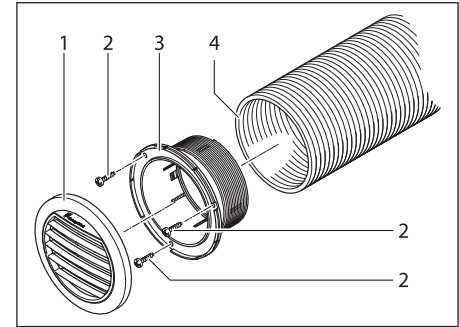

1. Air outlet
2. Self-tapping screw 3.9 x 13, EN ISO 7049
3. Pipe connection socket
4. Flexible tubing

### Installing the air blocking element



#### CAUTION!

#### Risk of overheating!

Blocking the hot air can cause overheating of the heater; the heater is switched off by the protection against overheating.

- The air blocking element may only be used in multi-duct air systems.

# AUXILIARY HEATER

## Airtronic/Airtronic M

The air blocking element is clipped into the pipe connection socket, discharge side. This reduces the cross-section of the pipe connection socket and reduces the quantity of air flow.

The air blocking element consists of two rings; the inner ring can be broken out. 1 ring = low degree of air blocking / 2 rings = high degree of air blocking

The air blocking element is available in sizes  $\varnothing 75$  mm and  $\varnothing 90$  mm (Order No. see product information).

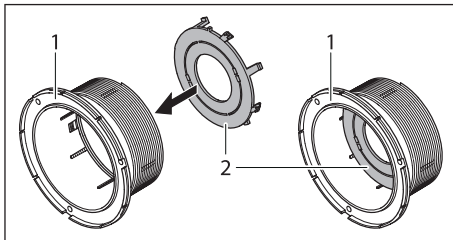

1. Connection sockets, discharge side
2. Air blocking element

### Exhaust system

#### Mounting the exhaust system

The "Universal" and "Plus" installation kits include a flexible exhaust pipe, inner  $\varnothing 24$  mm, 1000 mm long and an exhaust silencer. The flexible exhaust pipe can be shortened to 20 cm or lengthened to max. 2 m, depending on the installation conditions. Fasten the exhaust silencer to a suitable position in the vehicle. Use a pipe clip to fix a short exhaust pipe end (with end sleeve) to the exhaust silencer (Anzugsdrehmoment 7+0.5 Nm). Use a pipe clip (tightening torque 7+0.5 Nm) to fix a short exhaust end pipe (with end sleeve) to the exhaust silencer.



### CAUTION!

#### Safety instructions!

The whole exhaust system gets very hot during and immediately after the heater has been working. This is the reason why the exhaust system must be installed according to these instructions.

- The exhaust outlet must end in the open air.
- The exhaust pipe must not protrude beyond the lateral limits of the vehicle.

- Install the exhaust pipe sloping slightly downwards. If necessary, make a drain hole approx.  $\varnothing 5$  mm at the lowest point to drain off condensation.
- Important functional parts of the vehicle must not be impaired (keep sufficient clearance).
- Mount the exhaust pipe with sufficient clearance to heat-sensitive parts. Pay particular attention to fuel pipes (plastic or metal), electrical cables and brake hoses etc.!
- Exhaust pipes must be fastened safely (recommended clearance of 50 cm) to avoid damage from vibrations.
- Route the exhaust system so that the emitted fumes are not sucked in with the combustion air.
- The mouth of the exhaust pipe must not get clogged by dirt and snow.
- The mouth of the exhaust pipe must not point in the direction of travel.
- Always fasten the exhaust silencer to the vehicle.

# AUXILIARY HEATER

## Airtronic/Airtronic M



### **DANGER!**

#### **Risk of injuries and burns!**

Every type of combustion produces high temperatures and toxic exhaust fumes. This is the reason why the exhaust system must be installed according to these instructions.

- Do not perform any work on the exhaust system while the heater is working.
- Before working on the exhaust system, first switch the heater off and wait until all parts have cooled down completely, wear safety gloves if necessary.
- Do not inhale exhaust fumes.



### **Please note!**

- Comply with the regulations and safety instructions for this chapter on page 4 – 7.
- If a silencer is fitted, the exhaust end pipe must be much shorter than the flexible exhaust pipe between the heater and the exhaust silencer.
- Small arrows indicating the direction of flow have been cast into the fittings to differentiate between the combustion air and the exhaust fittings at the heater (see diagram page 23).
- To prevent contact erosion, the clips used to fix the exhaust pipe must be made of stainless steel. The order No.

for the stainless steel fixing clips is given in the product information.

#### **Combustion air system**

##### **Mounting the combustion air system**

The universal installation kit includes a flexible combustion air hose, inner Ø 25 mm, 1000 mm long.

If necessary the flexible combustion air hose can be shortened to 20 cm or lengthened to max. 2 m depending on the installation conditions.

Use a pipe clip (tightening torque 3+0.5 Nm) to fix the flexible combustion air hose to the heater and use hose clips or cable ties to fix in suitable positions.

Fit an end sleeve after completing the installation.

The „Plus“ installation kit includes a combustion air intake silencer with a flexible connection hose (inner diameter 25 mm). Use a pipe clip (tightening torque 3+0.5 Nm) to fix the flexible connection hose to the heater and use hose clips or cable ties to fix in suitable positions. Fit an end sleeve after completing the installation.



### **CAUTION!**

Safety instructions for the combustion air system!

- The combustion air opening must be free at all times.
- Position the combustion air intake to be sure that exhaust fumes cannot be sucked in with the combustion air.
- Do not arrange the combustion air intake to point against the wind blast.
- The combustion air intake must not get clogged with dirt and snow.
- Install the combustion air intake system sloping slightly downwards. If necessary, make a drain hole approx. Ø 5 mm at the lowest point to drain off condensation.



### **Please note!**

- For Airtronic and Airtronic M heaters a combustion air intake silencer can be fitted instead of the combustion air hose to reduce the noise level. Order No. see spare parts list or product information.
- Comply with the regulations and safety instructions for this chapter on page 4 – 7.

# AUXILIARY HEATER

## Airtronic/Airtronic M

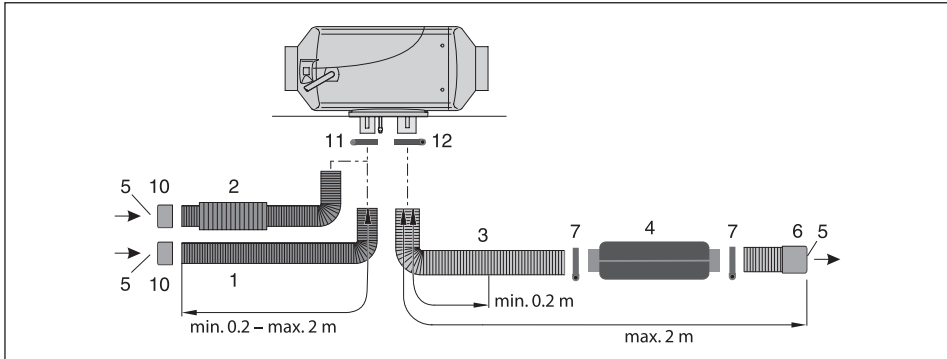

- 1 Combustion air hose, di = 25 mm
- 2 Combustion air silencer,  
– Included in the “Plus” installation kit
- 3 Exhaust pipe, di = 24 mm
- 4 Exhaust silencer
- 5 Intake / outlet opening – protect from wind, snow, dirt and water.
- 6 End sleeve, combustion air
- 7 End sleeve, exhaust
- 8 Combustion air connection
- 9 Exhaust connection
- 10 End sleeve, combustion air
- 11 Hose clip
- 12 Exhaust hose clip

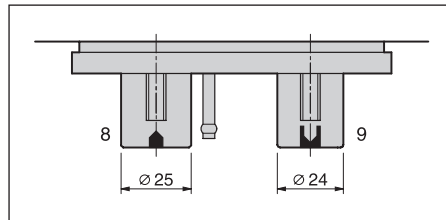

# AUXILIARY HEATER

## Airtronic/Airtronic M

### Fuel supply

#### Mounting the dosing pump, routing the fuel pipes and mounting the fuel tank

The following safety instructions must be observed when mounting the dosing pump, routing the fuel pipes and mounting the fuel tank.

Deviations from the instructions stated here are not allowed. Failure to comply can result in malfunctions.



**DANGER!**

#### Risk of fire, explosion, poisoning and injuries!

Caution when handling fuel.

- Switch off the vehicle engine and heater before refuelling and before working on the fuel supply.
- No naked lights when handling fuel.
- Do not smoke.
- Do not inhale fuel vapours.
- Avoid any contact with the skin.



**CAUTION!**

#### Safety instructions for routing the fuel pipes!

- Only use a sharp knife to cut off fuel hoses and pipes. Interfaces must not be crushed and must be free of burrs.
- The fuel pipe from the dosing pump to the heater should be routed at a continuous rise.
- Fuel pipes must be fastened safely to avoid any damage and / or noise production from vibrations (recommended clearance of approx. 50 cm).
- Fuel pipes must be protected from any mechanical damage.
- Route the fuel pipes so that any distortion of the vehicle, engine movements etc. can not have any lasting effect on the service life.
- Use hose clips to secure all hose connections in the fuel supply (tightening torque 1+0.2 Nm).
- Parts carrying fuel must be protected from interfering heat.
- Never route or fasten the fuel pipes to the heater or vehicle exhaust system. At crossings, always ensure adequate heat clearance, if necessary attach

heat deflection plates or protective hose (For Order No. of protective hose, see product information).

- Dripping or evaporating fuel must never be allowed to collect on hot parts or ignite on electric systems.
- When connecting fuel pipes with a fuel hose, always mount the fuel pipes in a butt joint to prevent any bubbles from forming.

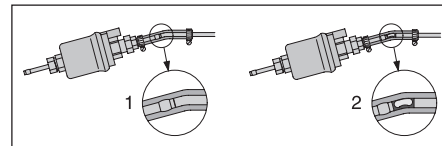

1 Correct connection

2 Incorrect connection – bubble formation

#### Safety instructions for fuel pipes and fuel tanks in buses and coaches

- In buses and coaches, fuel pipes and fuel tanks must not be routed through the passenger compartment or driver's cab.
- Fuel tanks in buses and coaches must be positioned in such a way that the exits are not in direct danger from a possible fire.

# AUXILIARY HEATER

## Airtronic/Airtronic M



### Please note!

- Comply with the regulations and safety instructions for this chapter on page 4 – 7.
- For noise reasons, do not rigidly t fuel pipes onto structural sound transferring components.  
A sponge rubber hose can be pushed over the fuel tubes for noise reduction.

# AUXILIARY HEATER

## Airtronic/Airtronic M

### Fuel supply

Fuel feed point with T-piece from the fuel return line from the tank leading to the vehicle engine

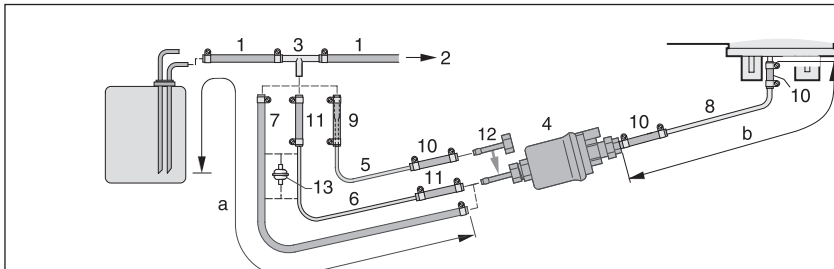

1. Fuel return line, vehicle tank
2. To the vehicle's engine, mechanical fuel or injection pump
3. T-piece, 8-6-8 or 10-6-10
4. Dosing pump
5. Fuel pipe, 4 x 1 (di = Ø 2 mm)
6. Fuel pipe, 6 x 2 (di = Ø 2 mm)
7. Fuel hose, 5 x 3 (di = Ø 5 mm)
8. Fuel pipe, 4 x 1.25 (di = Ø 1,5 mm)
9. Adapter Ø 6 / 4
10. Fuel hose, 3,5 x 3 (di = Ø 3.5 mm), approx. 50 mm long
11. Fuel hose, 5 x 3 (di = Ø 5 mm), approx. 50 mm long

12. Pipe connectors, da = Ø 4 mm
13. Fuel filter - required for contaminated fuel only.

\*If necessary, a fuel pipe 4 x 1 (di = Ø 2 mm) can be used for diesel heaters instead of the fuel pipe 4 x 1.25 (di = Ø 1,5 mm), Item (8).

The details regarding the pipe lengths remain unchanged. The fuel pipe, 4 x 1 must be order separately. Order No. see spare parts list or product information.

### Possible pipe lengths

**Intake side**  
Airtronic  
a = max.  
5 m

Airtronic M  
a = max.  
2 m

### Pressure side

Diesel heaters

- For suction pipe di = Ø 2 mm, b = max. 6 m
- For suction pipe di = Ø 5 mm, b = max. 10 m

Petrol heater

- b = max. 4 m



### Please note!

- Insert the T-piece (3) in the fuel return line upstream of the feed pump.
- Items (5), (9) and (12) are included in the „Plus“ installation kit only.
- Item (6) is included in the universal installation kit only.
- Items (7) and (13) must be ordered separately. The order no. is given in the product information.



# AUXILIARY HEATER

## Airtronic/Airtronic M

### Installation position of the T-piece

Use the installation positions shown in the diagram when inserting a T-piece.

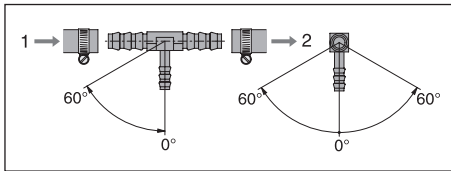

1. Direction of flow from the fuel tank
2. Direction of flow to the vehicle engine

# AUXILIARY HEATER

## Airtronic/Airtronic M

### Fuel supply

Fuel feed point with tank connection – ascending pipe, integrated in the vehicle tank or in the tank fitting

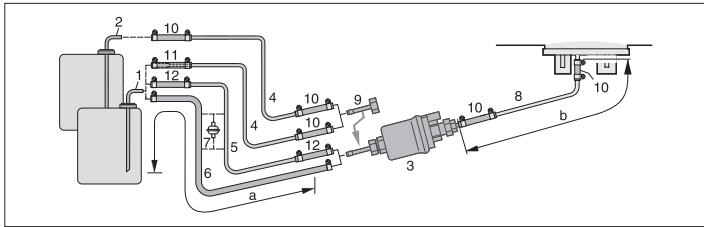

1. Tank connection for metal tank - di = Ø 2 mm, da = Ø 6 mm
2. Tank connection for tank fitting - di = Ø 2 mm, da = Ø 4 mm
3. Dosing pump
4. Fuel pipe, 4 x 1 (di = Ø 2 mm)
5. Fuel pipe, 6 x 2 (di = Ø 2 mm)
6. Fuel hose, 5 x 3 (di = Ø 5 mm)
7. Fuel filter - required for contaminated fuel only.
8. Fuel pipe, 4 x 1.25 (di = Ø 1,5 mm)
9. Pipe connectors, da = Ø 4 mm

10. Fuel hose, 3,5 x 3 (di = Ø 3.5 mm) approx. 50 mm long
11. Adapter Ø 6 / 4
12. Fuel hose, 5 x 3 (di = Ø 5 mm), approx. 50 mm long

If necessary, a fuel pipe 4 x 1 (di = Ø 2 mm) can be used for diesel heaters instead of the fuel pipe 4 x 1.25 (di = Ø 1.5 mm), Item (8).  
The details regarding the pipe lengths remain unchanged. The fuel pipe, 4 x 1 must be order separately. Order No. see spare parts list or product information.

### Possible pipe lengths

#### Intake side

Airtronic  
a = max.  
5 m

Airtronic M  
a = max.  
2 m

#### Pressure side

Diesel heaters

- For suction pipe di = Ø 2 mm, b = max. 6 m
- For suction pipe di = Ø 5 mm, b = max. 10 m

Petrol heater

- b = max. 4 m



### Please note!

- Items (2), (4), (8), (9) and the connection parts are included in the "Tank Connection" kit, Order No. 22 1000 20 13 00 (The "Tank Connection" kit is included in the „Plus" installation kit).
- Item (5) is included in the universal installation kit only.
- Item (11) is included in the "Plus" installation kit only.
- Items (6) and (7) must be ordered separately. The order no. is given in the product information.
- When installing tank connection maintain a minimum distance of 50 ± 2 mm from the end of the riser pipe and the bottom of the tank.
- Consult the vehicle manufacturer before installing the tank connection in a metal tank.

# AUXILIARY HEATER

## Airtronic/Airtronic M



### CAUTION!

#### Safety instructions for the fuel supply!

- The fuel must not be conveyed by gravity or overpressure in the fuel tank.
- Withdrawal of fuel after the vehicle's fuel pump is not allowed.
- When the pressure in the fuel pipe is more than 0.2 bar to max. 4,0 bar, use a pressure reducer (order no. 22 1000 20 08 00) or separate tank connection.
- When the pressure in the fuel pipe is more than 4,0 bar or there is a non-return valve in the return pipe (in the tank), a separate tank connection must be used.
- When using a T-piece in a plastic pipe, always use support sleeves in the plastic. Connect the T-piece and the plastic pipe with corresponding fuel hoses and secure with hose clips.

#### Installation position of the dosing pump

Always mount the dosing pump with the pressure side rising upwards. Every installation position over 15° is allowed, although an installation position between 15° and 35° is preferable.

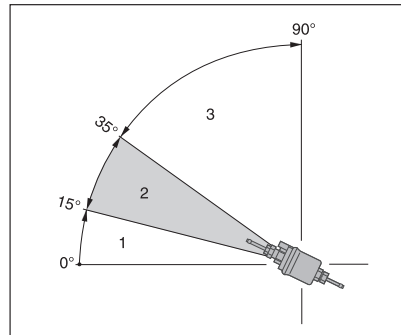

1. Installation position between 0° and 15° is not allowed.
2. Preferred installation position in range 15° to 35°.
3. Installation position in range 35° to 90° is allowed.

#### Possible suction and pressure height of the dosing pump

Pressure height from vehicle tank to dosing pump: a = max. 3000 mm  
Intake height in pressure-less vehicle tank:

- b = max. 1000 mm for diesel
- b = max. 1500 mm for petrol

Intake height in vehicle tanks with withdrawal by negative pressure (valve with 0.03 bar in tank cap):  
b = max. 400 mm

Pressure height of the dosing pump to the heater: c = max. 2000 mm

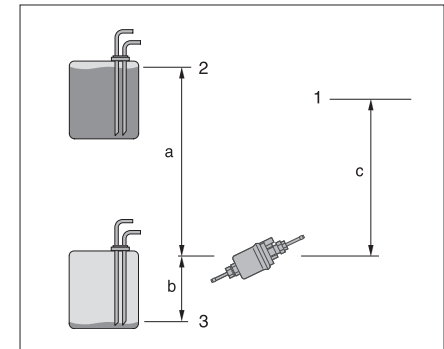

1. Connection to heater
2. Max. fuel level
3. Min. fuel level

# AUXILIARY HEATER

## Airtronic/Airtronic M



### Please note!

Check tank venting.



### CAUTION!

#### Safety instructions for installing the dosing pump

- Always mount the dosing pipe with the pressure side rising upwards – minimum incline 15°.
- Protect the dosing pump and filter from intolerable heat, do not mount near to the silencers and exhaust pipes.



### CAUTION!

#### Fuel supply safety information

It is not permitted to operate the heater with unapproved fuel / fuel mixtures or the addition of used oil.

Failure to comply with this can lead to personal injuries as well as a malfunction or damage to the heater.

Only the fuel approved by the manufacturer or by the vehicle manufacturer is to be used.

#### Fuel quality for petrol heaters

The heater runs without problems on normal commercial petrol according to DIN EN 228.

#### Fuel quality for diesel heaters

- The heater runs without problems on normal commercial diesel fuel according to DIN EN 590.
- During the winter months the diesel fuel is adapted to low temperatures from 0 °C to –20 °C. Problems can therefore only arise if outdoor temperatures are extremely low - which also applies to the vehicle's engine - please refer to the vehicle manufacturer's regulations.
- In special cases and at outdoor temperatures above 0 °C the heater can also be run on heating oil EL according to DIN 51603.
- If the heater is run from a separate tank, please comply with the following rules:
  - if outdoor temperatures over 0 °C, Use diesel fuel according to DIN EN 590.
  - if outdoor temperatures from 0 °C to 20 °C, Use winter diesel fuel according to DIN 590.
  - if outdoor temperatures –20 °C to –40 °C, Use Arctic Diesel or Polar Diesel.



### Please note!

After refuelling with winter or cold diesel, the fuel pipes and the metering pump must be filled with the new fuel by letting the heater run for 15 min!

#### Operation with biodiesel (FAME)

#### Airtronic

The heater is not approved for operation with bio diesel fuel (FAME). Up to 10 % bio diesel fuel (FAME) may be added.

#### Airtronic M

The diesel heater is approved for operation with bio diesel fuel (FAME) according to DIN EN 14 214.



### Please note!

- Bio diesel fuel (FAME) according to DIN EN 14 214
  - during the winter months is adapted to low temperatures from 0 °C to –20 °C.
  - The Flowability reduces at temperatures below 0 °C.
- When using 100 % bio diesel, the heater should be operated twice a year with diesel fuel (in the middle and at the end of a heating period) in order to burn off any possible biodiesel residues deposited.
- To do so, let the vehicle tank run almost empty and then fill with diesel fuel. While running on this tank filling, switch the heater on 2 to 3 times for 30 minutes at a time at the highest temperature setting.
- When operating with diesel / bio diesel mixtures of up to 50 % bio diesel, intermediate operation with pure diesel fuel is not necessary.

# AUXILIARY HEATER

## Airtronic/Airtronic M

### Operating instructions

The heater is operated by a control element.

Detailed operating instructions are enclosed with the control unit.

#### Please note!

The workshop / garage installing the heater will issue you with the operating instructions.

### Important instructions for operation Safety checks before the start

After a lengthy period of non-use (summer months) check that all parts fit securely (tighten screws where necessary).

Check the fuel system visually for any leaks.

### Heating at high altitudes

- up to 1500 m altitude, heating mode is possible without altitude adjustment.
- from 1500 m – 3000 m, heating mode for short stays (e.g. if crossing a pass or stopping for a break) is possible without adjusting the heater altitude.

#### Please note!

In case of a lengthy stay, e.g. winter camping, it is necessary to adjust the heater's altitude.

The heater's altitude is adjusted by installing an air pressure sensor; this is included in the altitude kit – Order No. 22 1000 33 22 00.

### Initial commissioning

The following points are to be checked by the company installing the heater during initial commissioning.

- After installation of the heater, the coolant circuit and the whole fuel supply system must be vented carefully. Comply with the instructions issued by the vehicle manufacturer.
- During the trial run of the heater, check all water and fuel connections for leaks and mounting.
- If the heater shows a fault during operation, find and eliminate the cause of the fault using a diagnosis unit.

#### Please note!

During the initial start-up of the heater, odours can be produced for a short time. This is fully normal during the first few minutes of operation and does not indicate a malfunction in the heater.

### Description of functions

#### Switching on

When the heater is switched on, the control lamp in the control element lights up.

The glow plug is switched on and the fan starts at low speed.

#### Please note!

If there is still too much residual heat in the heat exchanger from when the heater was last used, firstly only the fan starts up (cold blowing).

Once the residual heat has been cleared, the heater starts.

# AUXILIARY HEATER

## Airtronic/Airtronic M

### Starting Airtronic

After approx. 65 seconds the fuel supply starts and the fuel / air mixture in the combustion chamber ignites.

Once the combined sensor ( flame sensor) has detected the flame, the glow plug is switched off after 60 seconds. The heater is now in standard operation.

### Starting Airtronic M

After approx. 60 seconds the fuel supply starts and the fuel / air mixture in the combustion chamber ignites.

After the flame sensor has detected the flame, the glow plug is switched off after approx. 90 sec. The heater is now in standard operation.

After another 120 seconds, the heater has reached the "POWER" stage (maximum fuel quantity, maximum fan speed).

### Temperature selection with the control element

The control can be used to preselect an interior temperature. The resulting temperature can be within the range of +10 °C to +30 °C and depends on the selected heater, on the size of the space to be heated and on the prevailing outdoor temperature. The setting to be selected at

the control is an empirical value.

### Control in the heating mode

During the heating mode, the room temperature or the temperature of the sucked in heating air is constantly measured.

If the temperature is higher than the temperature selected on the control element, the heater starts to regulate its output. There are 4 control stages so that the amount of heat produced by the heater can be adjusted in line with the heating requirements. Fan speed and fuel quantity correspond to the particular control stage.

If the set temperature is still exceeded in the smallest control stage, the heater goes to the "OFF" stage with the fan running on for approx. 4 minutes to cool down. Then the fan continues at minimum speed (circulation mode) or is switched off (fresh air mode) until the heater is started again.

### Ventilating mode

In the ventilating mode, first the changeover switch "heating / venting" has to be activated and then the heater is switched on.

### Switching off

When the heater is switched off, the control lamp goes off and the fuel supply is switched off.

The fan runs on for approx. 4 minutes to cool down.

While the fan is running on, the glow plug is switched on for approx. 40 seconds to clean.

Special case:

If no fuel has been supplied or if the heater is in the "OFF" stage until it is switched off, the heater is stopped without any after running.

# AUXILIARY HEATER

## Airtronic/Airtronic M

### Control and safety devices

- If the heater does not ignite within 90 seconds after starting the fuel pump, the start is repeated. If the heater still does not ignite after another 90 seconds of pumping fuel, the heater is switched off, i.e. the fuel supply is off and the fan runs on for approx. 4 minutes.
- If the flame goes out by itself during operation, the heater is restarted. If the heater does not ignite within 90 seconds after the fuel pump has started, or ignites and goes out again within 15 minutes, the heater is switched off, i.e. the fuel supply is off and the fan runs on for approx. 4 minutes. This status can be remedied by briefly switching off and on again. Do not repeat the switching off/on routine more than twice.
- In the case of overheating, the combined sensor ( flame sensor / overheating sensor) triggers, the fuel supply is interrupted and the heater switched off. Once the cause of the overheating has been eliminated, the heater can be re-started by switching off and on again.
- If the lower or upper voltage limit is reached, the heater is switched off after 20 seconds.
- The heater does not start up when the glow plug is defect or when the electric lead to the dosing pump is interrupted.
- If the combined sensor ( flame sensor / overheating sensor) is defect or the electric lead interrupted, the heater starts up and is then switched off again

during the start phase.

- The speed of the fan motor is monitored continuously. If the fan motor does not start up or if the speed deviates by more than 10%, the heater is switched off after 30 sec.
- When the heater is switched off, the glow plug is switched on for 40 seconds (after-glowing) while the fan runs on to clean off any combustion residues.



### Please note!

Do not switch the heater off and on again more than twice.

### Forced shutdown in ADR mode (only for diesel heaters 24 volt)

In vehicles for the transport of dangerous goods (e.g. tanker trucks), the heater must be switched off before the truck drives into a danger area (refinery, fuel service station, etc.).

Failure to comply results in the heater switching off automatically when:

- The vehicle engine is switched off.
  - An additional unit is started up (e.g. auxiliary drive for unloading pump etc.).
- The fan then runs on for max. 40 seconds.

### Emergency shutdown – EMERGENCY OFF

If an emergency shutdown – EMERGENCY OFF – is necessary during operation, proceed as follows:

- Switch the heater off with the control or
- pull the fuse out or
- disconnect the heater from the battery.

# AUXILIARY HEATER

## Airtronic/Airtronic M

### Heater wiring

The electronic control box is integrated in the heater, which considerably simplifies the wiring required during installation.



### CAUTION!

### Safety instructions for wiring the heater!

The heater is to be connected up electrically according to the EMC directives.

EMC can be affected if the heater is not connected up correctly. For this reason, comply with the following instructions:

- Ensure that the insulation of electrical cables is not damaged. Avoid: chafing, kinking, jamming or exposure to heat.
- In waterproof connectors, seal any connector chambers not in use with filler plugs to ensure they are dirt-proof and water-proof.
- Electrical connections and ground connections must be free of corrosion and firmly connected.
- Lubricate connections and ground connections outside the heater interior with contact grease.



### Please note!

- Comply with the following when wiring the heater and the control element:
- With the appropriate electrical wiring, the heater fulfils the ADR regulations; please refer to the circuit diagrams at the end of this document.
- Electrical leads, switchgear and controllers must be arranged in the vehicle so that they can function perfectly under normal operating conditions (e.g. heat exposure, moisture etc.).
- The following cable cross sections are to be used between the battery and heater. This ensures that the max. tolerable voltage loss in the cables does not exceed 0.5 V for 12 V or 1 V for 24 V rated voltage.
- Cable cross sections for a cable length of (plus cable + minus cable):
  - up to 5 m = cable cross section 4 mm<sup>2</sup>
  - from 5 to 8 m = cable cross section 6 mm<sup>2</sup>
- If the plus cable is to be connected to the fuse box (e.g. terminal 30), the vehicle cable from the battery to the fuse box must be included in rating the overall cable length and possibly re-dimensioned if necessary.
- Insulate unused cable ends.



# AUXILIARY HEATER

## Airtronic/Airtronic M

### Parts list for the circuit diagrams Airtronic / Airtronic M and Airtronic / Airtronic M – ADR mode

-A1	Airtronic / Airtronic M control box
-A30	Fuse holder, 3 pin
-B1	Control sensor, internal
-B6	Flame and overheating sensor
-F1	Fuse 12 V = 20 A / 24 V = 10 A
-M4	Burner motor
-R1	Glow plug
-Y1	Fuel metering pump

#### Optional

b	Activation of vehicle blower and / or separate fresh air fan
---	--



#### Please note!

- The plus signal is only applied in „Low“ control stage (PIN 16, plus signal for relay, I<sub>max</sub> = 200 mA)

#### ADR function

Wiring for ADR mode (dangerous goods in utility or commercial vehicles, e.g. fuel tanker) - wire yourself according to vehicle circumstances

m	Battery isolating switch
n	Generator D+
o	Auxiliary drive NA+



#### Please note!

- It must be ensured that if the battery isolating switch is pressed due to EMERGENCY STOP, all the heater's electric circuits are disconnected from the battery immediately (without any consideration of the heater's status).
- If the battery isolating switch is pressed to disconnect the battery from all electric circuits, the heater must be switched off first and if applicable you must wait until the heater's after-run has finished.

a to the heater

b to the control unit

x Insulate and tie back any cable ends that are not needed.



#### Please note!

Circuit diagram for Airtronic / Airtronic M see Page 34 and 35. Circuit diagram for Airtronic / Airtronic M in ADR mode - see also Page 36.

For circuit diagrams for other control units, e.g. EasyStart T, R and R+, refer to the installation instructions of the control unit concerned.

# AUXILIARY HEATER

## Airtronic/Airtronic M

Airtronic / Airtronic M

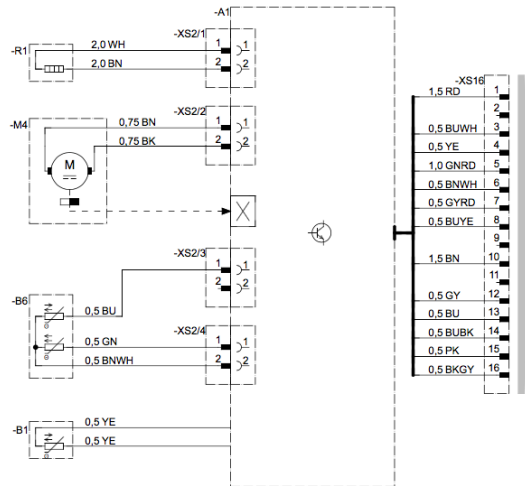
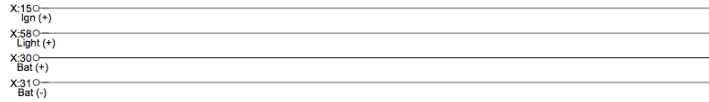

25.2069.0089.02.0A

# AUXILIARY HEATER

## Airtronic/Airtronic M

### Airtronic / Airtronic M

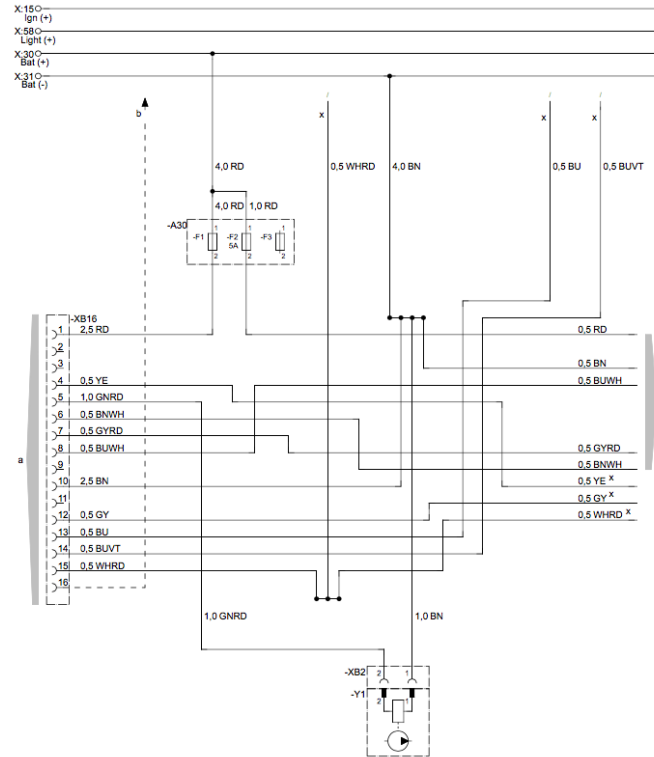

# AUXILIARY HEATER

## Airtronic/Airtronic M

### Circuit diagram Airtronic / Airtronic M – ADR mode

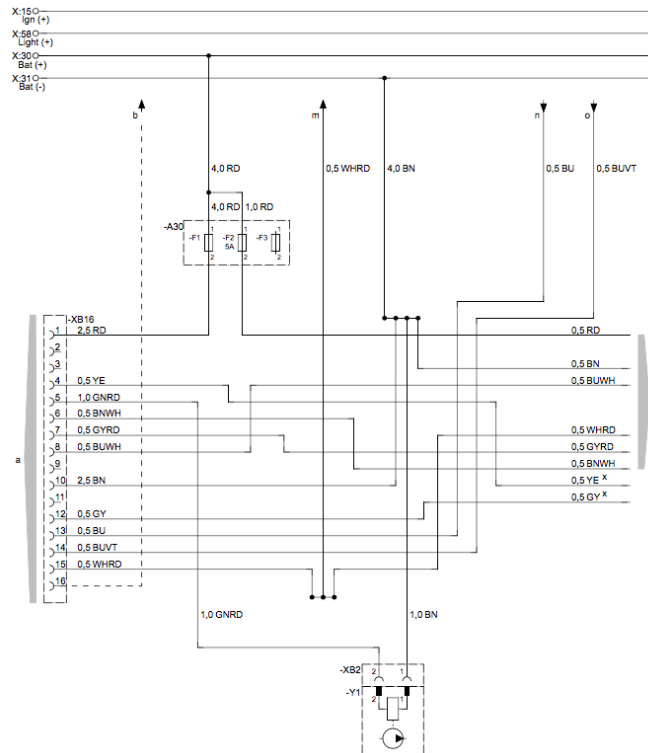

# AUXILIARY HEATER

## Airtronic/Airtronic M

### Circuit diagram EasyStart Timer

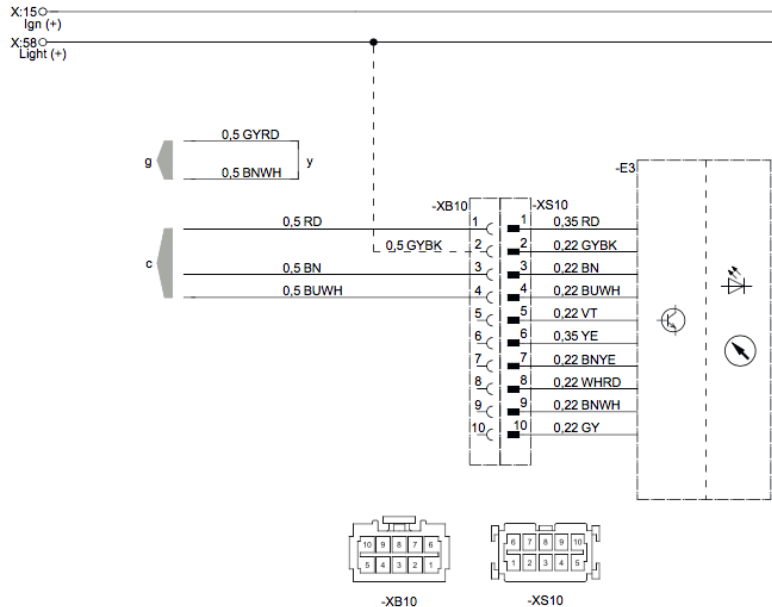

### Cable colours

RD = red  
BU = blue  
WH = white  
GY = grey  
YE = yellow

VT = violet  
BK = black  
GN = green  
BN = brown



### Please note!

- For heater circuit diagrams see page 34, 35 and 36.
- Further circuit diagrams for the EasyStart Timer are printed in the Installation Instructions Plus, these are available to view and download from the Service Portal.

E3 EasyStart Timer  
c to the heater  
g to the heater  
y Connect cables and insulate

22 1000 34 97 20

# AUXILIARY HEATER

## Airtronic/Airtronic M

### Circuit diagram EasyStart Remote+

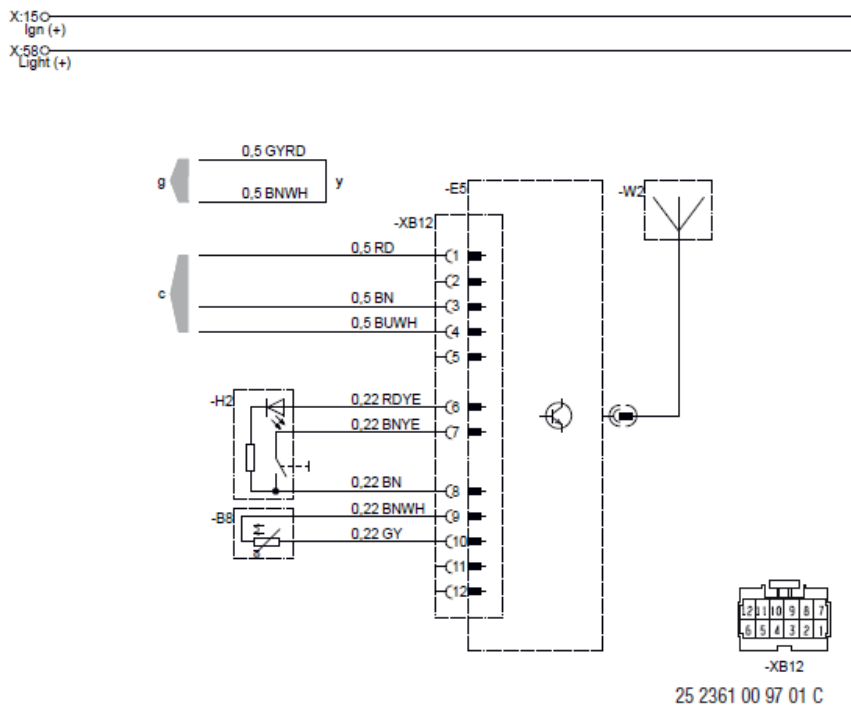

- B8 Room temperature sensor
- E5 EasyStart Remote+ radio remote control
- H2 Button
- W2 Antenna
- c to the heater
- g to the heater
- y Connect cables and insulate

### Cable colours

- |             |             |
|-------------|-------------|
| RD = red    | VT = violet |
| BU = blue   | BK = black  |
| WH = white  | GN = green  |
| GY = grey   | BN = brown  |
| YE = yellow |             |

### **Please note!**

- For heater circuit diagrams see page 34 and 35.
- Further circuit diagrams for the EasyStart Remote+ are printed in the Installation Instructions Plus, these are available to view and download from the Service Portal.

# AUXILIARY HEATER

## Airtronic/Airtronic M

### Circuit diagram EasyStart Select

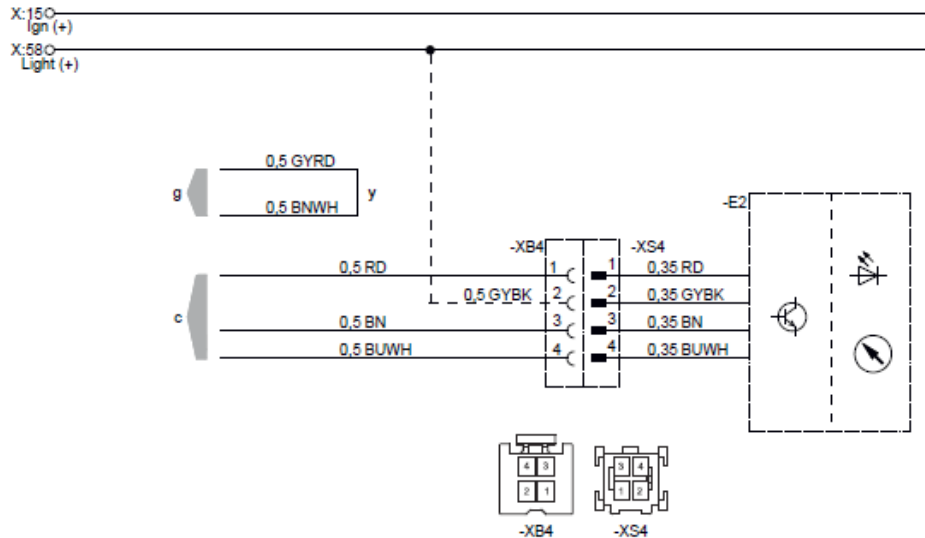

E2 EasyStart Select  
 c to the heater  
 g to the heater  
 y Connect cables and insulate

### Cable colours

RD = red                      VT = violet  
 BU = blue                    BK = black  
 WH = white                GN = green  
 GY = grey                  BN = brown  
 YE = yellow

### **!** Please note!

- For heater circuit diagrams see page 34 and 35.
- Further circuit diagrams for the EasyStart Select are printed in the Installation Instructions Plus, these are available to view and download from the Service Portal.

25 2361 00 97 05 B

# AUXILIARY HEATER

## Airtronic/Airtronic M

### Circuit diagram EasyStart Call

X:15 C —  
Ign (+)  
X:58 C —  
Light (+)

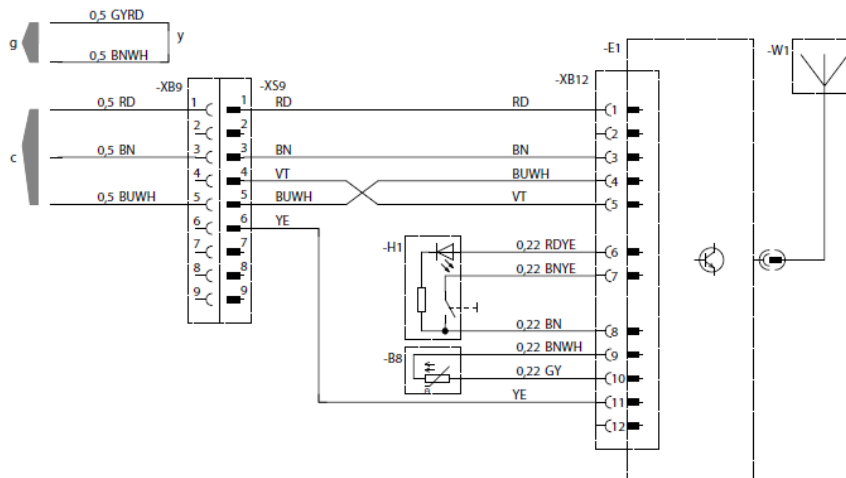

- B8 Room temperature sensor
- E1 EasyStart Call radio remote control
- H1 EasyStart Call button
- W1 EasyStart Call antenna
- c to the heater
- g to the heater
- y Connect cables and insulate

### Cable colours

- RD = red
- BU = blue
- WH = white
- GY = grey
- YE = yellow
- VT = violet
- BK = black
- GN = green
- BN = brown

### **Please note!**

- For heater circuit diagrams see page 34 and 35.
- Further circuit diagrams for the EasyStart Call are printed in the Installation Instructions Plus, these are available to view and download from the Service Portal.



# AUXILIARY HEATER

## Airtronic/Airtronic M

### In case of faults, please check the following points

- If the heater does not start after being switched on:
  - Switch the heater off and on again.
- If the heater still does not start, check whether:
  - There is fuel in the tank?
  - The fuses are OK?
  - The electrical cables, connections etc. are OK?
  - Anything is clogging the combustion air supply or exhaust system?

### Troubleshooting

If the heater remains faulty even after these points have been checked, or another malfunction occurs in your heater, please contact:

- For installation ex works, your contract workshop.
- For subsequent installation, the workshop who installed your heater.



### Please note!

Please note that warranty claims can be become void if the heater is changed by a third party or by this installation of third parts.

### Maintenance instructions

- Switch the heater on once a month for about 10 minutes, even outside the heating period.
- Before the heating period starts, the heater should undergo a trial run. If persistent extreme smoke develops, unusual burning noises or a clear fuel smell can be perceived or if electric / electronic parts heat up, the heater must be switched off and put out of service by removing the fuse. In this case, the heater should not be started up again until it has been checked by qualified staff who have been trained on Eberspächer heaters.
- Check the openings of the combustion air supply and exhaust system after longer standstill periods, clean if necessary!

### Service

### Technical Support

If you have any technical questions or problems with the heater, the control unit or the operating software, please contact the following service address:  
Please note! support-UK@eberspaecher.com

# AUXILIARY HEATER

## Airtronic/Airtronic M

### Certification

The high quality of Eberspächer's products is the key to our success.

To guarantee this quality, we have organised all work processes in the company along the lines of quality management (QM).

Even so, we still pursue a large number of activities for continuous improvement of product quality in order to keep pace with the similarly constantly growing requirements made by our customers.

All the steps necessary for quality assurance are stipulated in international standards.

This quality is to be considered in a total sense.

It affects products, procedures and customer / supplier relationships.

Officially approved public experts assess the system and the corresponding certification company awards a certificate.

Eberspächer Climate Control Systems GmbH has already qualified for the following standards:

**Quality management as per ISO TS 9001:2015 and IATF 16949:2016  
Environment management system as per ISO 14001:2015**

### Disposal

#### Disposal of materials

Old devices, defect components and packaging material can all be separated and sorted into pure-grade fractions so that all parts can be disposed of as required in an environment-friendly manner or recycled where applicable. Electric motors, controllers and sensors (e.g. temperature sensors) are deemed to be "electronic scrap".

#### Dismantling the heater

The heater is dismantled according to the repair stages in the current troubleshooting / repair instructions.

#### Packaging

The packaging of the heater can be kept in case it has to be sent back.

### EU Declaration of Conformity

We herewith declare that the version of the heater placed on the market by us conforms to the applicable provisions of the following EU Directive.

EU Directive 2014/30/EU



The full Declaration of Conformity can be viewed and downloaded from the download centre under [www.eberspaecher.com](http://www.eberspaecher.com).

### UKCA Declaration of Conformity

We herewith declare that the version of the heater placed on the market by us conforms to the applicable provisions of the following EU Directive.

Electromagnetic Compatibility, Statutory Instrument 2016, No. 1091



The full Declaration of Conformity can be viewed and downloaded from the download centre under [www.eberspaecher.com](http://www.eberspaecher.com)

# AUXILIARY HEATER

## Airtronic/Airtronic M

### List of abbreviations

#### **ADR**

European agreement about the international transport of dangerous goods on the road.

#### **ECE regulation**

Internationally agreed, uniform technical specifications for vehicles, parts and equipment of motor vehicles

#### **EMC directive**

Electromagnetic compatibility.

#### **JE partner**

Eberspächer partner.

#### **FAME**

Biodiesel according to DIN V 14 214.

#### **CE marking**

With the CE marking, the manufacturer declares in a declaration of conformity, that the version of the heater placed on the market conforms to the relevant provisions of the EU Directive.

# AUXILIARY HEATER

## Hydronic M-II

### Special text structure, presentation and picture symbols

This manual uses special text structures and picture symbols to emphasise different contents.

Please refer to the examples below for the corresponding meanings and associated actions.

Special structure and presentations

A dot (·) indicates a list which is started by a heading. If an indented dash (–) follows a dot, this list is subordinate to the dot.

### Picture symbols



**REGULATION!**

This picture symbol with the remark “Regulation” refers to a statutory regulation. Failure to comply with this regulation results in expiry of the type permit for the heater and preclusion of any guarantee and liability claims on J. Eberspächer GmbH & Co. KG.



**DANGER!**

This picture symbol with the remark “Danger!” refers to the risk of a fatal

danger to life and limb. Under certain circumstances, failure to comply with these instructions can result in severe or life-threatening injuries.



**CAUTION!**

This picture symbol with the remark “Caution!” refers to a dangerous situation for a person and/or the product. Failure to comply with these instructions can result in injuries to people and / or damage to machinery.



**Please note!**

These remarks contain application recommendations and useful tips for installation of the heater.

### Important information before starting work

#### Range of application of the heater

The water heater operating independently of an engine is intended for installation in the following vehicles, depending on its heating output:

- Vehicles of all kinds
- Construction machinery
- Agricultural machinery

- Boats, ships and yachts



**Please note!**

- Installation of the heater is permitted in vehicles used for the transport of dangerous goods as per ADR.
- The heater is not approved for installation in vehicle compartments used by persons (more than 8 passenger spaces) in Class M2 and M3 vehicles (vehicles for the transport of passengers / commercial buses).
- The heater is not approved for installation in the driver or passenger compartments of Class M1 vehicles (vehicles for the transport of passengers / cars) and Class N vehicles (vehicles for the transport of goods).

On account of its functional purpose, the heater is not permitted for the following applications:

- Long-term continuous operation, e.g. for pre-heating and heating of:
  - Residential rooms
  - Garages
  - Work huts, weekend homes and hunting huts
  - Houseboats, etc.

# AUXILIARY HEATER

## Hydronic M-II



### CAUTION!

#### Safety instructions for application and proper purpose

The heater must only be used and operated for the range of application stated by the manufacturer in compliance with the "Operating instructions" included with every heater.

#### Statutory regulations

The Federal Road Transport Directorate has issued an "EC type approval" and an "EMC type approval" for the heater for installation in motor vehicles and with the following official type approval marks, noted on the heater name plate.

Hydronic M-II                      EG-00 0215

EMV-035075



### REGULATION!

#### Directive 2001 / 56 / EU of the European Parliament and the Council

- Arrangement of the heater
- Parts of the structure and other components near the heater must be

protected from excess heat exposure and possible contamination from fuel or oil.

- The heater must not pose a fire hazard even when it overheats. This requirement is deemed to be fulfilled when adequate clearance to all parts is observed during installation, sufficient ventilation is provided and fireproof materials or heat plates are used.
- The heater may not be mounted in the passenger compartment of Class M2 and M3 vehicles. A unit may however be used in a hermetically sealed housing which also corresponds to the conditions stated above.
- The factory nameplate or duplicate must be affixed so that it can still be easily read when the heater is installed in the vehicle.
- All appropriate precautions must be taken when arranging the heater to minimise the risk of injuries to persons or damage to other property.

#### • Fuel supply

- The fuel intake connection must not be located in the passenger compartment and must be sealed with a properly closing lid to prevent any fuel leaks.
- In heaters for liquid fuel where the

heater fuel is separate from the vehicle fuel, the type of fuel and intake connection must be clearly identified.

- A warning sign is to be fixed to the intake connection indicating that the heater must be switched off before refuelling.

#### • Exhaust system

- The exhaust outlet must be arranged so as to prevent any penetration of exhaust fumes into the vehicle interior through the ventilation system, warm air intakes or open windows.

#### • Combustion air intake

- The air for the heater combustion chamber must not be sucked in from the passenger compartment of the vehicle.
- The air intake must be arranged or protected in such a way that it cannot be blocked by other objects.
- Operating status display
- A clearly visible operating display in the user's field of vision must indicate when the heater is switched on and off.

# AUXILIARY HEATER

## Hydronic M-II

§

### REGULATION!

#### Additional regulations for certain vehicles named in Directive 94 / 55 / EC (ADR Framework Directive)

##### Scope

This appendix applies to vehicles for which the special provisions of Directive 94 / 55 / EC apply to combustion heaters and their installation.

##### Definition of terms used

For the purposes of this appendix, the vehicle designations „EX / II“, „EX / III“, „AT“, „FL“ and „OX“ according to Chapter 9.1 of Annex B of Directive 94 / 55 / EC are used.

##### Technical regulations

#### General provisions (EX / II, EX / III, AT, FL and OX vehicles)

##### Avoid heating and ignition

The combustion heaters and their exhaust gas routing shall be designed, located, protected or covered so as to prevent any unacceptable risk of heating or ignition of the load. This requirement shall be

considered as fulfilled if the fuel tank and the exhaust system of the appliance conform to provisions in 3.1.1.1 and 3.1.1.2.

Compliance with these regulations shall be checked in the complete vehicle.

##### Fuel tanks

Fuel tanks for supplying the heater shall conform to the following regulations:

- In the event of any leakage, the fuel shall drain to the ground without coming into contact with hot parts of the vehicle or the load;
- fuel tanks containing petrol shall be equipped with an effective flame trap at the filler opening or with a closure enabling the opening to be kept hermetically sealed.

##### Exhaust system and exhaust pipe layout

The exhaust system as well as the exhaust pipes shall laid out or protected to avoid any danger to the load through heating or ignition. Parts of the exhaust system situated directly below the fuel tank (diesel) shall have a clearance of at least 100 mm or be protected by a thermal shield.

##### Switching on the combustion heater

The combustion heater may only be switched on manually. Automatic switching on via a programmable switch is not permitted.

##### EX / II and EX / III vehicles

Combustion heaters for gaseous fuels are not permitted.

##### FL vehicles

Combustion heaters must be able to be taken out of service/disabled at least by the methods described in the following:

- a) Switching off manually in the driver's cabin
- b) Switching off the vehicle's engine; in this case the heater may be manually switched back on by the vehicle driver;
- c) Starting up of a feed pump installed in the vehicle for the dangerous goods carried.

##### Combustion heater after-run

After-running of the switched off combustion heater is permitted. In the cases named in the „FL vehicles“ paragraph under letters b) and c) the supply of combustion air must be interrupted by suitable means after a maximum after-run period of 40 seconds.

# AUXILIARY HEATER

## Hydronic M-II

Only combustion heaters whose heat exchangers are verifiably not damaged by the reduced after-run period of 40 seconds beyond their usual use period may be used.



### Please note!

- Compliance with the statutory regulations, the additional regulations and safety instructions is prerequisite for guarantee and liability claims. Failure to comply with the statutory regulations and safety instructions and incorrect repairs even when using original spare parts make the guarantee null and void and preclude any liability for J. Eberspächer GmbH & Co. KG.
- Subsequent installation of this heater must comply with these installation instructions.
- The statutory regulations are binding and must also be observed in countries which do not have any special regulations.
- When the heater is to be installed in vehicles not subject to the German Ordinance for the Registration of Motor Vehicles (StVZO), for example ships, the specially valid regulations and installation instructions for these special applications must be observed.
- Installation of the heater in special vehicles must comply with the

- regulations applying to such vehicles.
- Other installation requirements are contained in the corresponding sections of this manual.

### Safety instructions for installation and operation



### DANGER!

#### Risk of injury, fire and poisoning

- Disconnect the vehicle battery before starting any kind of work.
- Before working on the heater, switch the heater off and let all hot components cool down.
- The heater must not be operated in enclosed rooms, e.g. in the garage or multi-storey car park.



### CAUTION!

#### Safety instructions for installation and operation

- The heater must only be installed by a JE partner authorised by the manufacturer according to the instructions in this manual and possibly according to special installation recommendations; the same applies to any repairs to be carried out in the case of repairs or guarantee claims.
- Repairs by non-authorised third-parties

or with not original spare parts are dangerous and therefore not allowed. They result in expiry of the type permit of the heater; consequently, when installed in motor vehicles they can cause expiry of the vehicle operating licence.

- The following measures are not allowed:
  - Changes to components relevant to the heater.
  - Use of third-party components not approved by J. Eberspächer GmbH & Co. KG.
  - Nonconformities in installation or operation from the statutory regulations, safety instructions or specifications relevant to safe operation as stated in the installation instructions and operating instructions. This applies in particular to the electrical wiring, fuel supply, combustion air system and exhaust system.
- Only original accessories and original spare parts may be used during installation or repairs.
- Only original accessories and spare parts may be used for installation or repairs.
- Only the controls approved by Eberspächer may be used to operate the heater. The use of other controls can result in malfunctions.
- Before the heater is installed again in another vehicle, rinse the heater parts carrying water with clear water.

# AUXILIARY HEATER

## Hydronic M-II

- When carrying out electric welding on the vehicle, the plus pole cable at the battery should be disconnected and placed at ground to protect the controller.
- The heater must not be operated where there is a risk of an accumulation of flammable vapours or dust, for example close to
  - fuel depot
  - coal depot
  - wood depot
  - grain depots etc.
- The heater must be switched off when refuelling.
- When the heater is mounted in a safety housing etc., the installation compartment of the heater is not a stowage compartment and must be kept clear. In particular fuel canisters, oil cans, spray cans, gas cartridges, fire extinguishers, cleaning rags, items of clothing, paper etc. must not be stored or transported on or next to the heater.
- Defect fuses must only be replaced by fuses with the prescribed rating.
- If fuel leaks from the heater fuel system, arrange for the damage to be repaired immediately by a JE service partner.
- When topping up the coolant, only use the coolant permitted by the vehicle manufacturer, see the vehicle operating

manual. Any blending with unpermitted coolant can cause damage to the engine and heater.

- After-running of the heater must not be interrupted prematurely e.g. by pressing the battery disconnecting switch, apart from in the case of an emergency stop.

### Accident prevention

General accident prevention regulations and the corresponding workshop and operation safety instructions are to be observed.



# AUXILIARY HEATER

## Hydronic M-II

### Scope of supply

Quantity / Designation	Order number
1 Hydronic M8 Biodiesel	
12 Volt	25 2470 05 00 00
24 Volt	25 2471 05 00 00
To be ordered separately:	
1 Universal installation kit	25 2435 80 00 00
1 Control unit*	-
1 Hydronic M10	
12 Volt	25 2434 05 00 00
24 Volt	25 2435 05 00 00
To be ordered separately:	
1 Universal installation kit	25 2435 80 00 00
1 Control unit*	-
1 Hydronic M12	
12 Volt	25 2472 05 00 00
24 Volt	25 2473 05 00 00
To be ordered separately:	
1 Universal installation kit	25 2435 80 00 00
1 Control unit*	-

\* Control units see price list / accessories catalogue..



### Please note!

- The cable harness, Order No. 25 2435 80 06 00, is also required for vehicles used for transporting dangerous goods.
- Please consult the additional parts catalogue if any other parts are required for installation.

### Parts list for the „Scope of supply“ figure on page 9

#### Hydronic M8 Biodiesel heater scope of supply

Picture-No.	Designation
1	Heater
2	Metering pump
21	Tube, Ø 6 x 1. length 6 m
22	Transition piece Ø 3.5 / 5, (2 x)
-	Hose clamp Ø 10, (4 x)

#### Hydronic M10 / M12 heater scope of supply

Picture-No.	Designation
1	Heater
2	Metering pump

# AUXILIARY HEATER

## Hydronic M-II

### Universal installation kit scope of supply

Picture-No.	Designation
3	Relay 12 V / 24 V
4	Exhaust silencer
5	Cable tree, heater
6	Bracket, heater
7	Flexible exhaust pipe
8	Cable ties (10 x)
9	Pipe, Ø 6 x 1, length 1,5 m
10	Hose, Ø 5 x 3, length 0,5 m
11	Pipe, Ø 4 x 1, length 6 m
12	Hose, Ø 3,5 x 3, length 10 cm
13	Intake silencer for combustion air
14	Water hose
15	Water hose
16	Lead harness, metering pump
17	Lead harness, blower
18	Corrugated tube, Inner Ø 10 mm, length 2 m
19	Grommet
20	Bracket
-	Small parts

### Cable harnesses

A	„Controls“ lead harness
B	„Blower control“ lead harness
C	Positivecable
D	Negativecable
E	Connection, blower relay positive supply cable at the fuse holder
F	Connection at blower relay, terminal 85 (1-pole, brown)
G	Connection at blower relay, terminal 86 (1-pole, red/yellow)
H	Metering pump connection

# AUXILIARY HEATER

## Hydronic M-II

### Scope of supply

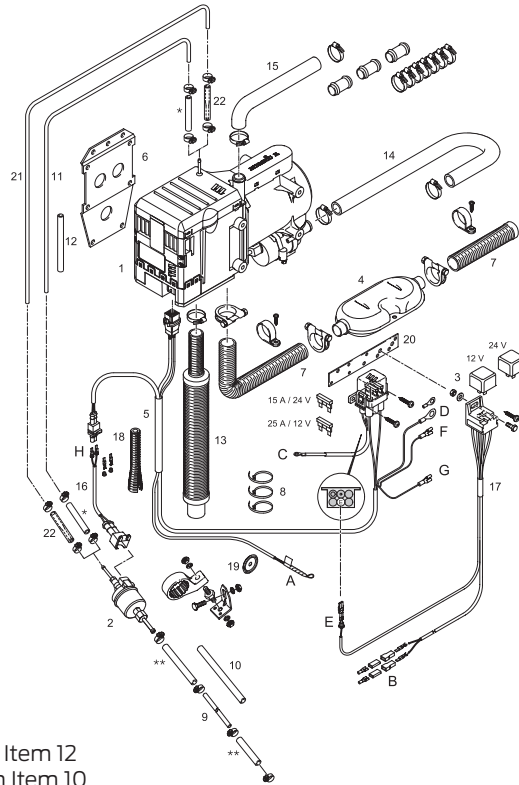

\* make from Item 12  
\*\*make from Item 10

# AUXILIARY HEATER

## Hydronic M-II

### Technical data

Heater type	<b>Hydronic M-II</b>			
Heater	Hydronic M8 Biodiesel			
Version	D 8 W			
Heating medium	Mixture of water and coolant (max. 50 % water, 50 % coolant)			
Control of the heat flow	Power	Large	Medium	Small
Heat flow (watt) Figures for operation with diesel fuel. If operated with FAME the heat flow can reduce by up to 15 %.	8000	5000	3500	1500
Fuel consumption (l/h)	0.90	0.65	0.40	0.18
Electrical power (watt)	in operation	55	46	39
	at start – after 25 Sek.	200		
	in the control phase “OFF”	32		
Rated voltage	in the control phase “OFF”		12 Volt	20 Volt
Operating range · Lower voltage limit: An undervoltage protection in the controller switches the heater off on reaching the voltage limit.  · Upper voltage limit: An overvoltage protection in the controller switches the heater off on reaching the voltage limit.			10 Volt	20 Volt
			15 Volt	30 Volt
Tolerable operating pressure	up to 2 bar overpressure			
Flow rate of the water pump at 0.14 bar	1400 l/h			

# AUXILIARY HEATER

## Hydronic M-II

· Minimum water flow rate of the heater		500 l/h	
Fuel – see also “Fuel quality diesel heaters” page 27		Commercially available diesel (DIN EN 590) FAME – for diesel engines according to DIN EN 14 214	
Tolerable ambient temperature		Operation	Not running
Heater / Control box	Diesel	–40 °C to +80 °C	–40 °C to +85 °C
	FAME	–8 °C to +80 °C	–40 °C to +85 °C
Dosing pump	Diesel	–40 °C to +50 °C	–40 °C to +85 °C
	FAME	–8 °C to +50 °C	–40 °C to +85 °C
Interference suppression class		interference suppression class 5 to DIN EN 55 025	
Weight with controller and water pump, without dosing pump		approx. 6.2 kg	



### CAUTION!

#### Safety instructions for technical data!

Failure to comply with the technical data can result in malfunctions.



### Please note!

Provided no limit values are given, the technical data listed is subject to the tolerances usually applicable to heaters of  $\pm 10\%$  for nominal voltage, ambient temperature 20 °C and reference altitude Esslingen.

# AUXILIARY HEATER

## Hydronic M-II

### Technical data

Heater type	<b>Hydronic M-II</b>				
Heater	Hydronic M10				
Version	D 10 W				
Heating medium	Mixture of water and coolant (max. 50 % water, 50 % coolant)				
Control of the heat flow	Power	Large	Medium	Small	
Heat flow (watt)	9500	8000	3500	1500	
Fuel consumption (l/h)	1.2	0.9	0.4	0.18	
Electrical power (watt)	in operation	86	60	39	
		at start – after 25 Sek.			
		in the control phase "OFF"			
Rated voltage	12 Volt		24 Volt		
Operating range	10 Volt		20 Volt		
	15 Volt		30 Volt		
Tolerable operating pressure	up to 2 bar overpressure				
Flow rate of the water pump at 0.14 bar	1400 l/h				

# AUXILIARY HEATER

## Hydronic M-II

· Minimum water flow rate of the heater	500 l/h	
Fuel – see also “Fuel quality diesel heaters” page 27	Commercially available diesel (DIN EN 590)	
Tolerable operating temperature	Operation	Not running
	Heater / Control box	–40 °C to +85 °C
	Dosing pump	–40 °C to +85 °C
Interference suppression class	interference suppression class 5 to DIN EN 55 025	
Weight with controller and water pump, without dosing pump	approx. 6.2 kg	



### CAUTION!

#### Safety instructions for technical data!

Failure to comply with the technical data can result in malfunctions.



### Please note!

Provided no limit values are given, the technical data listed is subject to the tolerances usually applicable to heaters of  $\pm 10\%$  for nominal voltage, ambient temperature 20 °C and reference altitude Esslingen.

# AUXILIARY HEATER

## Hydronic M-II

### Technical data

Heater type	<b>Hydronic M-II</b>					
Heater	Hydronic M12					
Version	D 12 W					
Heating medium	Mixture of water and coolant (max. 50 % water, 50 % coolant)					
Control of the heat flow	Power	Large	Medium 1	Medium 2	Medium 3	Small
Heat flow (watt)	12000	9500	5000	5000	1500	1200
Fuel consumption (l/h)	1.5	1.2	0.65	0.40	0.18	0.15
Electrical power (watt)	in operation	132	60	86	46	34
	at start – after 25 Sek.	120				
	in the control phase “OFF”	32				
Rated voltage	12 Volt			24 Volt		
Operating range	10 Volt			20 Volt		
<ul style="list-style-type: none"> <li>Lower voltage limit: An undervoltage protection in the controller switches the heater off on reaching the voltage limit.</li> </ul>						
<ul style="list-style-type: none"> <li>Upper voltage limit: An overvoltage protection in the controller switches the heater off on reaching the voltage limit.</li> </ul>	15 Volt			30 Volt		
Tolerable operating pressure	up to 2 bar overpressure					
Flow rate of the water pump at 0.14 bar	1400 l/h					



# AUXILIARY HEATER

## Hydronic M-II

Minimum water flow rate of the heater	500 l/h	
Fuel – see also “Fuel quality diesel heaters” page 27	Commercially available diesel (DIN EN 590)	
Tolerable operating temperature	Operation	Not running
	Heater / Control box	–40 °C to +80 °C
	Dosing pump	–40 °C to +85 °C
Interference suppression class	interference suppression class 5 to DIN EN 55 025	
Weight with controller and water pump, without dosing pump	approx. 6.2 kg	



### CAUTION!

#### Safety instructions for technical data!

Failure to comply with the technical data can result in malfunctions.



### Please note!

Provided no limit values are given, the technical data listed is subject to the tolerances usually applicable to heaters of  $\pm 10\%$  for nominal voltage, ambient temperature 20 °C and reference altitude Esslingen.

# AUXILIARY HEATER

## Hydronic M-II

### Main dimensions

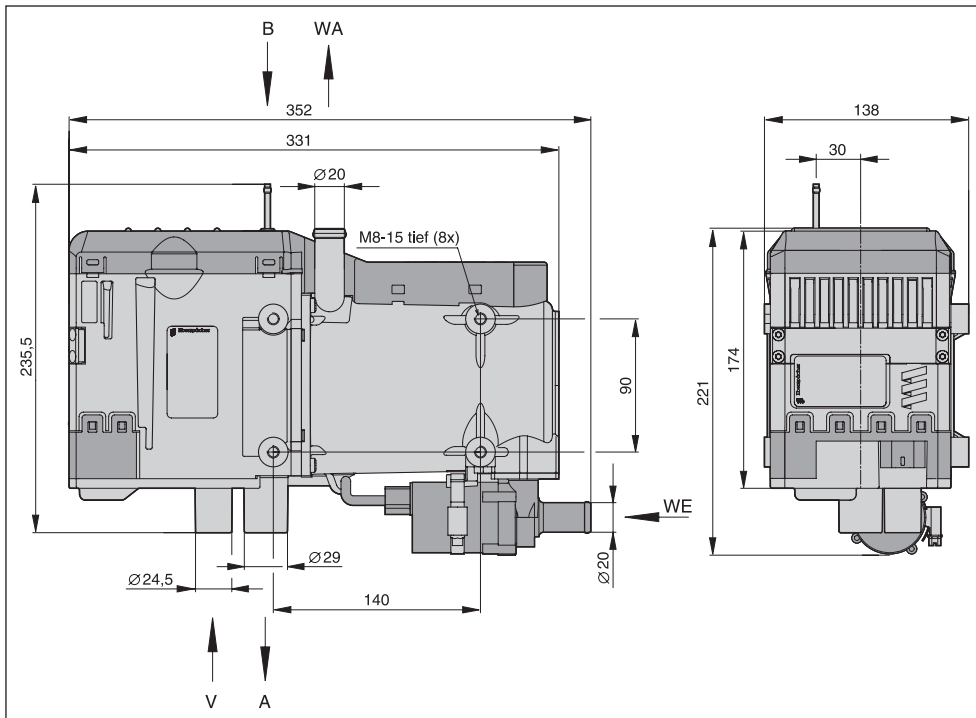

A Exhaust  
B Fuel  
V Combustion air  
WA Water outlet WE  
Water inlet

# AUXILIARY HEATER

## Hydronic M-II

### Installation location

The installation location for the heater is the engine compartment. The heater must be mounted below the min. cooling water level (compensation tank, cooler, ve- hicle heat exchanger) for automatic venting of the heat exchanger of the heater and the water pump.



### Please note!

- In a truck, the water heater is preferably fastened underneath the driver's cab in the longitudinal beam near the vehicle engine.
- The regulations and safety instructions to be observed for this chapter are stated on page 4 – 7.
- The installation suggestions made in the installation instructions are examples. Other installation locations are possible if they correspond to the installation requirements stated in these installation instructions.
- Other installation information (e.g. for boats and ships) is available from the manufacturer on request.
- Please take note of the installation locations together with the operating and storage temperatures.

### Installation example heater in a truck

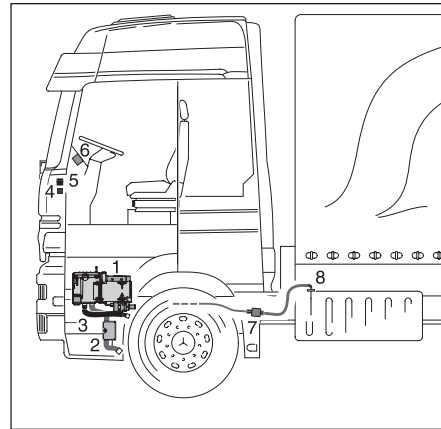

- 1 Heater
- 2 Exhaust pipe with exhaust silencer
- 3 Combustion air intake silencer
- 4 Fanrelay
- 5 Fusebracket
- 6 Controls
- 7 Dosingpump
- 8 Tankconnection

### Installing the 24 V heater in a vehicle for the transport of dangerous goods as per ADR

For installation of the heater in vehicles for the transport of dangerous goods, the regulations of ADR / ADR99 must be observed.

With the appropriate electrical wiring the heater fulfils the ADR regulations, see the “Additional Regulations” on Page 6, the “Control and Safety Devices” on Page 29 and the “Circuit Diagrams” on Page 34 and 39.

Detailed information about the ADR regulations is contained in leaflet no. 25 2161 95 15 80.

# AUXILIARY HEATER

## Hydronic M-II

### Possible installation positions

The heater should preferably be installed in the normal position, horizontal with the exhaust connection down to the bottom. Depending on the installation conditions, the heater can also be mounted in the permitted swivel range, see diagram.

When the heater is operating, the shown normal or maximum installation positions can be varied briefly by up to  $+15^\circ$  in all directions. Such deviations caused by the inclined position of the vehicle do not impair the heater functions in any way.

### Normal position with permitted swivel range

- Swivel range from the normal position swivelled up to max.  $85^\circ$  downward – the heater's water outlet socket is horizontal. The water pump's water inlet socket must face downward.
- Swivel range from the normal position swivelled up to max.  $90^\circ$  to the left about the longitudinal axis – the water outlet socket is at the top of the heater and faces the left.

# AUXILIARY HEATER

## Hydronic M-II

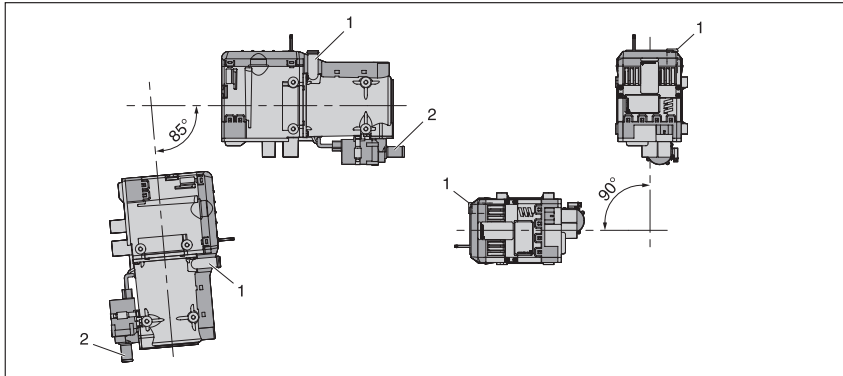

- 1 Water outlet socket, heater
- 2 Water inlet socket, water pump

# AUXILIARY HEATER

## Hydronic M-II

### Mounting and fastening

Fix the unit holder from the installation kit to the heater using 4 hexagon screws M8 and 4 spring washers (tightening torque 12+0.5 Nm).

Fix the heater and the mounted unit holder in a suitable 5 place in the vehicle using 5 hexagon screws M8, 5 spring washers and 5 hexagon nuts M8 (tightening torque 12+0.5 Nm).

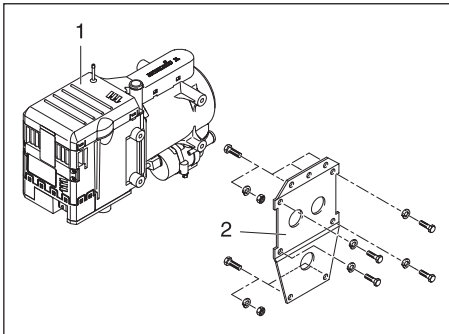

1 Heater  
2 Heaterbracket

### Nameplate

The nameplate is on the front and the 2nd nameplate (duplicate) is fixed to the side of the control box / fan unit.

If required, the installer can stick the duplicate nameplate in a clearly visible position elsewhere on the heater or near to the heater.



### Please note!

The regulations and safety instructions to be observed for this chapter are stated on page 5.

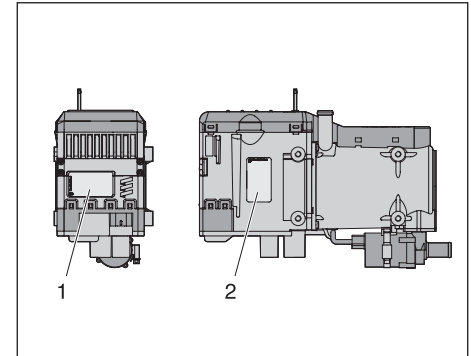

1 Originalnameplate  
2 2nd nameplate (dupliate)

# AUXILIARY HEATER

## Hydronic M-II

### Connection to the cooling water circuit

The heater is connected to the cooling water circuit in the water feed pipe from the vehicle engine to the heat exchanger. There are three possible alternative installations here. The alternatives are described on pages 16 – 18.



### DANGER!

### Risk of injuries and burns!

It is possible for the coolant and components of the coolant circuit to get very hot.

- Parts conveying water must be routed and fastened in such a way that they pose no temperature risk to man, animals or material sensitive to temperature from radiation / direct contact.
- Before working on the coolant circuit, switch the heater off and wait until all components have cooled down completely, if necessary where safety gloves.



### Please note!

- When installing the heater, please take note of the direction of flow of the coolant circuit.
  - Fill the heater and water hoses with coolant before connecting to the coolant circuit.
  - Route the water hoses without any kinks, and in a rising position if possible. When routing the water pipes, observe a sufficient clearance to hot vehicle parts.
  - Protect all water hoses / water pipes from chafing and from extreme temperatures.
  - Secure all hose connections with hose clips. (tightening torque = 1.5 Nm)
  - After the vehicle has been operating for 2 hours or travelled 100 km, tighten the hose clips again.
  - The minimum water flow rate is only guaranteed if the temperature difference of the heating medium does not exceed 15 K between water inlet and water outlet during heating.
  - Only overpressure valves with an opening pressure of min. 0.4 – max. 2 bar may be used in the coolant circuit.
  - The coolant liquid must contain at least 10 % antifreeze- ze all year round as corrosion protection.
  - The cooling liquid must contain sufficient antifreeze for low temperatures.
- Before commissioning the heater or after changing the cooling liquid, the whole coolant circuit including heater must be vented free of bubbles according to the instructions issued by the vehicle manufacturer.
  - Only top up with coolant approved by the vehicle manufacturer.

# AUXILIARY HEATER

## Hydronic M-II

### Connection to the cooling water circuit

#### Integrate the heater with non-return valve in the coolant circuit

Disconnect the water feed pipe from the vehicle engine to the vehicle heat exchanger and insert the non-return valve. Connect the heater with its water pipes to the non-return valve.

#### Advantage:

Simple installation.

#### Disadvantage:

The coolant flows through the vehicle engine constantly so that in large vehicle engines, adequate cab heating is scarcely possible.

#### Heating characteristics:

When the heater is switched on, the heat flows through the vehicle heat exchanger and the vehicle engine. Once the cooling water has reached a temperature of approx. 55 °C, depending on the selected fan setting the vehicle fan is switched on and the heat is also conveyed to the passenger compartment.

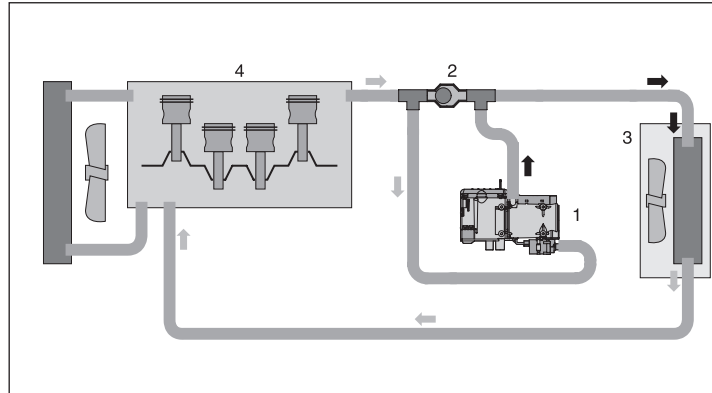

- 1 Heater
- 2 Non-return valve
- 3 Heatexchanger
- 4 Vehicleengine



#### Please note!

Non-return valve must be ordered separately, see additional parts catalogue for Order No.



# AUXILIARY HEATER

## Hydronic M-II

### Connection to the coolant circuit

#### Integrate the heater with non-return valve, thermostat and T-piece in the coolant circuit

Disconnect the water feed pipe from the vehicle engine to the vehicle heat exchanger and insert the non-return valve.

Disconnect the water return pipe from the heat exchanger to the vehicle engine and insert the T-piece.

Connect the heater and thermostat with water hoses to the non-return valve and T-piece as shown in the diagram.

#### Option:

In addition a solenoid can be fitted in the water circuit. When open, this bypasses the thermostat and pre-heats the engine as soon as the heater starts to work.

#### Heating characteristics

##### • Small coolant circuit: fast heating of the passenger compartment

Initially the heat produced by the heater is only conveyed to the vehicle heat exchanger up to a cooling water temperature of approx. 70 °C.

The vehicle fan switches on at approx.

55 °C.

##### • Large cooling water circuit: heating of the passenger compartment and additional engine pre-heating

If the cooling water temperature continues to increase, the thermostat slowly changes over to the large circuit (full change-over at approx. 75 °C).

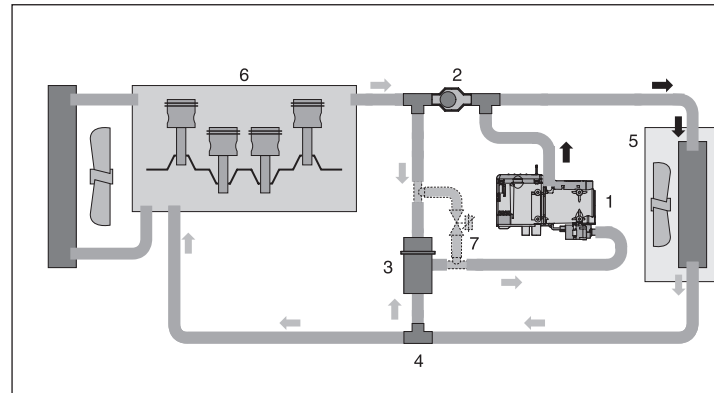

- 1 Heater
- 2 Non-return valve
- 3 Thermostat
- 4 T-piece

- 5 Heat exchanger
- 6 Vehicle engine
- 7 Solenoid (option)

# AUXILIARY HEATER

## Hydronic M-II



### Please note!

The thermostat, non-return valve and T-piece must be ordered separately, see additional parts catalogue for Order No. The solenoid valve has to be purchased through the trade.

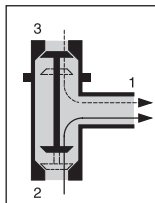

### Thermostat functions

#### Small coolant circuit

Cooling water temperature  $< 70\text{ }^{\circ}\text{C}$ :  
Connection no. 1: open to the heater  
Connection no. 2: open to the T-piece  
Connection no. 3: closed to the non-return valve

#### Large coolant circuit

Cooling water temperature  $> 75\text{ }^{\circ}\text{C}$ :  
Connection no. 1: open to the heater  
Connection no. 2: closed to the T-piece  
Connection no. 3: open to the non-return valve

- 1 Connection to the heater
- 2 Connection to the T-piece
- 3 Connection to the non-return valve



### Please note!

Integrate the thermostat into the water circuit with connections (1) (2) and (3) as shown in the diagram.

# AUXILIARY HEATER

## Hydronic M-II

### Connection to the coolant circuit

#### Integrate the heater with a solenoid in the coolant circuit

Disconnect the water flow hose from the vehicle's engine to the vehicle's heat exchanger and insert two T-pieces. Connect the T-pieces with a hose. Disconnect the water return pipe from the heat exchanger to the vehicle engine and insert the solenoid. Connect the heater and the solenoid to the T-piece with water pipes, as shown in the diagram.

#### Option:

In addition, a non-return valve with connection hoses between the two T-pieces can be inserted in the cooling water circuit. This prevents the loss of effective vehicle heating when the heater is switched off.

#### Heating characteristics

By installing the electric solenoid valve, temperature-independent choice between the small cooling water circuit (driver's cab) and large cooling water circuit (vehicle engine with driver's cab) is possible.

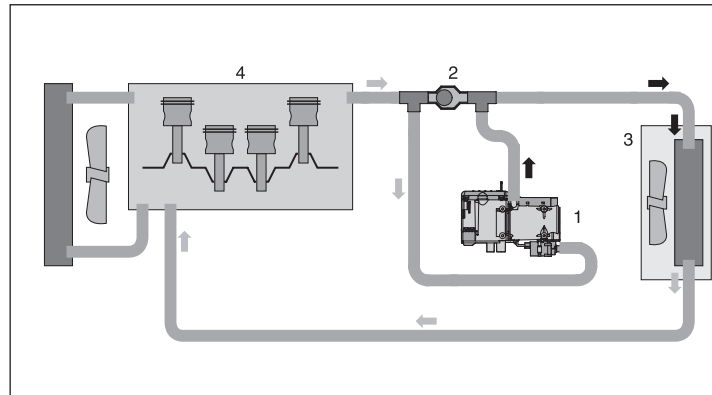

- 1 Heater
- 2 Solenoid
- 3 T-piece
- 4 Heatexchanger
- 5 Vehicleengine
- 6 Non-returnvalve (option)



#### Please note!

The T-pieces and non-return valve must be ordered separately. For Order No., see additional parts catalogue. The solenoid valve has to be purchased through the trade.

# AUXILIARY HEATER

## Hydronic M-II

### Exhaust system

(Exhaust diagram see page 22)

### Mounting the exhaust system

The universal installation kit includes a flexible exhaust pipe, inner  $\varnothing$  30 mm, 1300 mm long and an exhaust silencer.

The flexible exhaust pipe can be shortened to 20 cm or lengthened to max. 1.8 m, depending on the installation conditions (See sketch on page 22).

Fasten the exhaust silencer to a suitable position in the vehicle.

Route the flexible exhaust pipe from the heater to the exhaust silencer and fasten with pipe clips.

If necessary, also fasten the flexible exhaust pipe with pipe clips at suitable positions in the vehicle.

Connect the exhaust end pipe to the exhaust silencer with an end sleeve and fasten with a pipe clip.



**DANGER!**

### Risk of injuries and burns!

Every type of combustion produces high temperatures and toxic exhaust fumes.

This is the reason why the exhaust system must be installed according to these instructions.

- Do not perform any work on the exhaust system while the heater is working.
- Before working on the exhaust system, first switch the heater off and wait until all parts have cooled down completely, wear safety gloves if necessary.
- Do not inhale exhaust fumes.



**CAUTION!**

### Safety instructions for the exhaust system!

- The exhaust outlet must end in the open air.
- The exhaust pipe must not protrude beyond the lateral limits of the vehicle.
- Install the exhaust pipe sloping slightly downwards. If necessary, make a drain hole approx.  $\varnothing$  5 mm at the lowest point to drain off condensation.
- Important functional parts of the vehicle must not be impaired (keep sufficient clearance).
- Mount the exhaust pipe with sufficient clearance to heat-sensitive parts. Pay particular attention to fuel pipes (plastic or metal), electrical cables and brake hoses etc.!
- Exhaust pipes must be fastened safely (recommended clearance of 50 cm) to avoid damage from vibrations.

- Route the exhaust system so that the emitted fumes are not sucked in with the combustion air.
- The mouth of the exhaust pipe must not get clogged by dirt and snow.
- The mouth of the exhaust pipe must not point in the direction of travel.
- Always fasten the exhaust silencer to the vehicle.



**Please note!**

- Comply with the regulations and safety instructions for this chapter on page 4 – 7.
- The exhaust end pipe should be much shorter than the flexible exhaust pipe from the heater to the ex- haust silencer.
- Use pipe clips to secure all connections in the exhaust system.

# AUXILIARY HEATER

## Hydronic M-II

### Combustion air system

Mounting the combustion air system  
The universal installation kit includes an intake silencer, inner Ø 25 mm for the combustion air.

The intake silencer must be installed and, if necessary, can be extended by up to 2 m max using a flexible pipe (inner Ø 25 mm) and a connection pipe (outer Ø 24 mm) – not included in the scope of supply.

Fasten the intake silencer and where applicable the flexible pipe at suitable points in the vehicle using fastening clips and cable ties.



#### Please note!

- Comply with the regulations and safety instructions for this chapter on page 4 – 7.
- Extension of the intake silencer is not allowed if mainly heating mode is used at high altitudes (over 1000 m asl).
- Use pipe clips to secure all connections in the combustion air system.



#### CAUTION!

#### Safety instructions for the combustion air system!

- The combustion air opening must be free at all times.
- Position the combustion air intake to be sure that exhaust fumes cannot be sucked in with the combustion air.
- The combustion air intake must not get clogged with dirt and snow.
- Install the combustion air intake system sloping slightly downwards.
- If necessary, make a drain hole approx. Ø 5 mm at the lowest point to drain off condensation.
- Avoid tight bends when laying the intake silencer and flexible pipe.

# AUXILIARY HEATER

## Hydronic M-II

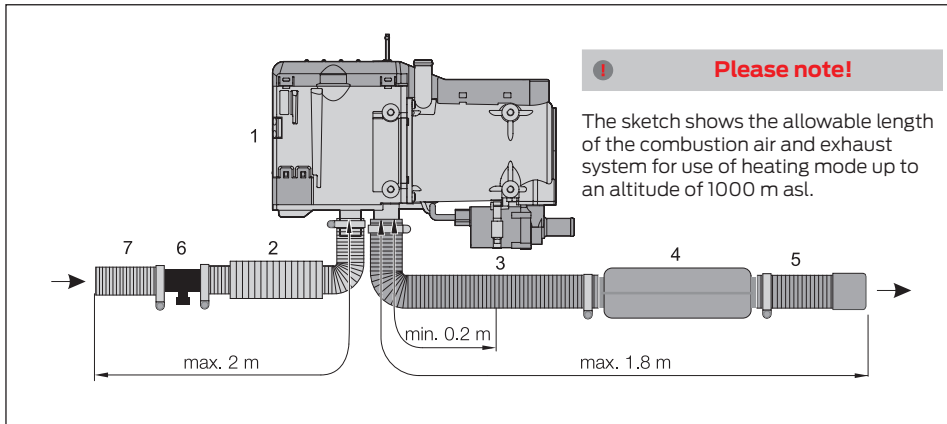

- 1 Heater
- 2 Intake silencer for the combustion air
- 3 Flexible exhaust pipe
- 4 Exhaust silencer
- 5 Flexible exhaust end pipe with end sleeve
- 6 Adapter with condensate outlet  
(Order No. 22 1050 89 40 00)
- 7 Flexible pipe (Order No. 10 2114 21 00 00)

# AUXILIARY HEATER

## Hydronic M-II

### Fuel supply

#### Mounting the dosing pump, routing the fuel pipes and mounting the fuel tank

The following safety instructions must be observed when mounting the dosing pump, routing the fuel pipes and mounting the fuel tank.



### DANGER!

#### Risk of fire, explosion, poisoning and injuries!

Caution when handling fuel.

- Switch off the vehicle engine and heater before refueling and before working on the fuel supply.
- No naked lights when handling fuel.
- Do not smoke.
- Do not inhale fuel vapours.
- Avoid any contact with the skin.



### CAUTION!

#### Safety instructions for routing the fuel pipes!

- Only use a sharp knife to cut off fuel hoses and pipes. Interfaces must not be crushed and must be free of burrs.
- The fuel pipe from the dosing pump

to the heater should be routed at a continuous rise.

- Fuel pipes must be fastened safely to avoid any damage and / or noise production from vibrations (recommended clearance of approx. 50 cm).
- Fuel pipes must be protected from any mechanical damage.
- Route the fuel pipes so that any distortion of the vehicle, engine movements etc. cannot have any lasting effect on the service life.
- Parts carrying fuel must be protected from interfering heat.
- Never route or fasten the fuel pipes to the heater or vehicle exhaust system. When the systems cross, always ensure there is a sufficient heat clearance. If necessary, install heat deflection plates.
- Dripping or evaporating fuel must never be allowed to collect on hot parts or ignite on electric systems.
- When connecting fuel pipes with a fuel hose, always mount the fuel pipes in a butt joint to prevent any bubbles from forming.

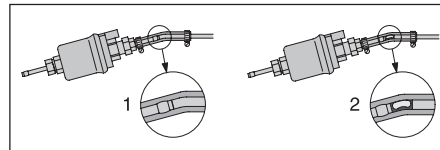

1 Correct connection

2 Incorrect connection – bubble formation



### Please note!

- Deviations from the instructions stated here are not allowed.
- Failure to comply can result in malfunctions.
- When replacing the Hydronic M (Hydronic 10) with the Hydronic M-II, the metering pump must be replaced too.

#### Safety instructions for fuel pipes and fuel tanks in buses and coaches

- In buses and coaches, fuel pipes and fuel tanks must not be routed through the passenger compartment or driver's cab.
- Fuel tanks in buses and coaches must be positioned in such a way that the exits are not in direct danger from a possible fire.



### Please note!

Comply with the regulations and safety instructions for this chapter on page 4 – 7.

# AUXILIARY HEATER

## Hydronic M-II

### Fuel supply

Fuel feed point with T-piece from the fuel supply line from the tank fitting to the vehicle engine

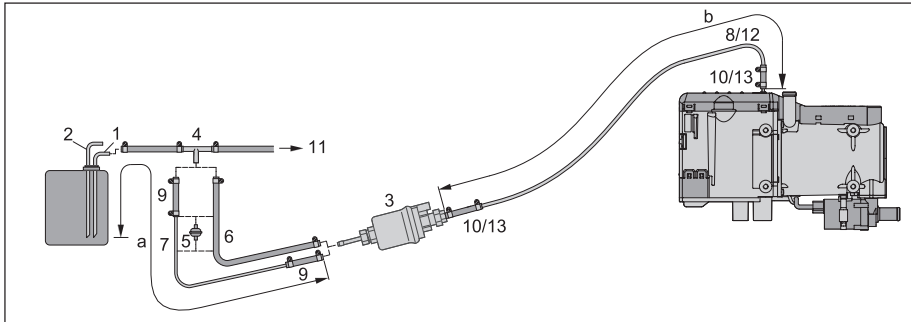

- 1 Fuel feed pipe from tank connection
- 2 Fuel return pipe to the tank connection
- 3 Dosing pump
- 4 T-piece
- 5 Fuel filter
- 6 Fuel hose, 5 x 3 (di = Ø 5 mm)
- 7 Fuel pipe, 6 x 1 (di = Ø 4 mm)
- 8 Fuel pipe, 4 x 1 (di = Ø 2 mm)
- 9 Fuel hose, 5 x 3 (di = Ø 5 mm), approx. 50 mm long

- 10 Fuel hose, 3,5 x 3 (di = Ø 3.5 mm), approx. 50 mm long
- 11 To the engine, mechanical fuel or injection pump.

Required for Hydronic M8 biodiesel for operation with FAME only.

- 12 Fuel pipe blue, 6 x 1 (di = Ø 4 mm)
- 13 Transition piece 3,5 / 5

### Possible pipe lengths

#### Intake side

a = max. 2 m

#### Pressure side

b = min. 1.5 m – max. 6 m



### Please note!

- Insert the T-piece (4) in the fuel flow line upstream of the feed pump. T-piece is not included in the “installation kit” scope of supply. The order no. is given in the additional parts catalogue.
- Fuel filter, Item (5), is required for contaminated fuel only. Fuel filter is not included in the “installation kit” scope of supply. The order no. is given in the additional parts catalogue.
- Items (12) and (13) are only included in the “Hydronic M8 Biodiesel” heater’s scope of supply.



# AUXILIARY HEATER

## Hydronic M-II

### Installation position of the T-piece

Use the installation positions shown in the diagram when inserting a T-piece.

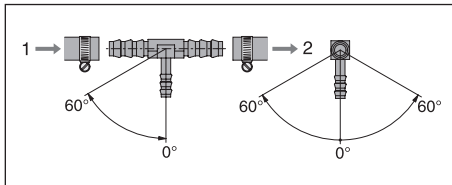

- 1 Direction of flow from the fuel tank
- 2 Direction of flow to the vehicle engine

# AUXILIARY HEATER

## Hydronic M-II

### Fuel supply

#### Fuel feed point with tank connection – ascending pipe, integrated in the vehicle tank

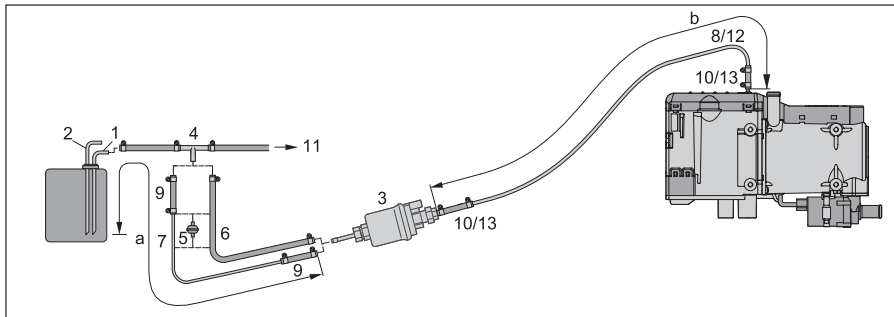

1 Tank connection for metal tank – di = Ø 4 mm, da = Ø 6 mm

2 Dosing pump

3 Fuel filter

4 Fuel hose, 5 x 3 (di = Ø 5 mm)

5 Fuel pipe, 6 x 1 (di = Ø 4 mm)

6 Fuel hose, 5 x 3 (di = Ø 5 mm), approx. 50 mm long

7 Fuel pipe, 4 x 1 (di = Ø 2 mm)

8 Fuel hose, 3,5 x 3 (di = Ø 3.5 mm), approx. 50 mm

Required for Hydronic M8 biodiesel for operation with FAME only.

9 Fuel pipe blue, 6 x 1 (di = Ø 4 mm)

10 Transition piece 3,5 / 5

### Possible pipe lengths

#### Intake side

a = max. 2 m

#### Pressure side

b = min. 1.5 m – max. 6 m



#### Please note!

- Item (1), tank connection for metal tank, is not included in the scope of supply “installation kit”. Order no. see extra parts catalogue.
- Fuel filter, Item (3), is required for contaminated fuel only. Fuel filter is not included in the “installation kit” scope of supply. The order no. is given in the additional parts catalogue.
- Items (9) and (10) are only included in the “Hydronic M8 Biodiesel” heater’s scope of supply.
- When installing tank connection maintain a minimum distance of  $50 \pm 2$  mm from the end of the riser pipe and the bottom of the tank.

# AUXILIARY HEATER

## Hydronic M-II



### CAUTION!

#### Safety instructions for the fuel supply!

- The fuel must not be conveyed by gravity or overpressure in the fuel tank.
- Withdrawal of fuel after the vehicle's fuel pump is not allowed.
- When the pressure in the fuel pipe is more than 4.0 bar or there is a non-return valve in the return pipe (in the tank), a separate tank connection must be used.
- When using a T-piece in a plastic pipe, always use support sleeves in the plastic. Connect the T-piece and the plastic pipe with corresponding fuel hoses and secure with hose clips.

#### Fuel supply

#### Installation position of the dosing pump

Always mount the dosing pump with the pressure side rising upwards. Every installation position over 15° is allowed, although an installation position between 15° and 35° is preferable.

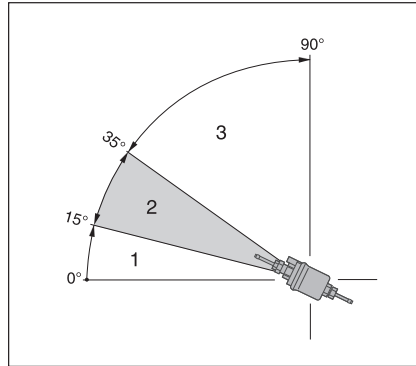

1. Installation position between 0° and 15° is not allowed.
2. Preferred installation position in range 15° to 35°.
3. Installation position in range 35° to 90° is allowed.

#### Possible intake and pressure height of the dosing pump

Pressure height from vehicle tank to dosing pump: a = max. 1000 mm  
Intake height for non-pressurised vehicle tank: b = max. 750 mm  
Intake height for a vehicle tank with withdrawal by negative pressure (valve with 0.03 bar in the tank lid): b = max. 400 mm  
Pressure height from the dosing pump to the heater: c = max. 2000 mm



### Please note!

Check tank venting.

# AUXILIARY HEATER

## Hydronic M-II

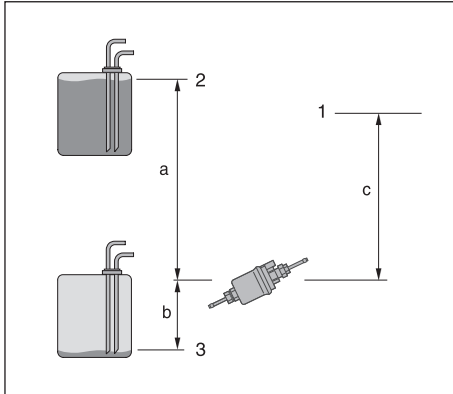

- 1 Connection to heater
- 2 Max. fuel level
- 3 Min. fuel level



### CAUTION!

#### Safety instructions for installing the dosing pump

- Always mount the dosing pump with the pressure side rising upwards – minimum incline 15°.
- Protect the dosing pump and filter from intolerable heat, do not mount near to the silencers and exhaust pipes.

#### Fuel quality

- Hydronic M8 Biodiesel, M10 and M12 heaters easily process standard diesel fuel to EN 590.
- During the winter months the diesel fuel is adapted to low temperatures from 0 °C to –20 °C. Problems can therefore only arise if outdoor temperatures are extremely low – which also applies to the vehicle's engine – please refer to the vehicle manufacturer's regulations.
- In special cases and at outdoor temperatures above 0 °C the heater can also be run on heating oil EL according to DIN 51603.
- If the heater is run from a separate tank, please comply with the following rules:
  - If outdoor temperatures over 0 °C: Use diesel fuel according to DIN EN 590.
  - If outdoor temperatures from 0 °C to –20 °C: Use winter diesel fuel according to DIN EN 590.
  - If outdoor temperatures –20 °C to –40 °C: Use Arctic Diesel or Polar Diesel.



### Please note!

- It is not permitted to add used oil!
- After refuelling with winter or cold diesel or the listed blends, the fuel pipes and the dosing pump must be filled with the new fuel by letting the heater run for 15 mins!

#### Operation with biodiesel

**(FAME for diesel engines according to DIN EN 14 214)**

#### Hydronic M8 Biodiesel

The heater is approved for operation with biodiesel up to a temperature of –8°C (the flowability reduces at temperatures below 0 °C).



### Please note!

- When using 100 % biodiesel, the heater should be run on diesel fuel twice a year (in the middle and at the end of a heating period) to burn off possibly accumulated biodiesel deposits. To do so, let the vehicle tank run almost empty and fill with diesel fuel without adding any biodiesel. While running on this tank filling, switch the heater on 2 to 3 times for 30 minutes at a time at the highest temperature setting.
- If constantly operated with diesel / biodiesel mixtures of up to 50 % biodiesel, intermediate operation with pure diesel fuel is not necessary.

#### Hydronic M10 / Hydronic M12

Both heaters are not approved for operation with biodiesel. Up to 10 % biodiesel may be added.

# AUXILIARY HEATER

## Hydronic M-II

### Operating instructions

The heater is operated by a control unit. The control unit is accompanied by detailed operating instructions which you will receive from the company installing the heater.

### Initial commissioning

The following points are to be checked by the company installing the heater during initial commissioning.

- After installation of the heater, the coolant circuit and the whole fuel supply system must be vented carefully. Comply with the instructions issued by the vehicle manufacturer.
- Open the coolant circuit before the trial run (set the temperature control to "WARM").
- During the trial run of the heater, check all water and fuel connections for leaks and firm fitting.
- If the heater shows a fault during operation, find and eliminate the cause of the fault using a diagnosis unit (Contact JE service partner).

### Important instructions for operation

#### Safety checks before the start

After a longer interval in operations (after the summer months) the fuse must be put in position and / or the heater connected

up to the battery. Check that all parts fit firmly (tighten screws where necessary). Check the fuel system visually for any leaks.

### Before switching on

Before switching on or pre-programming the heater, adjust the heating control in the vehicle to "WARM" (maximum setting) and the fan to "SLOW" (low power consumption).

In vehicles with automatic heating, adjust the heating control to "MAX" and open the heating vents before switching the ignition off.

### Temperature drop (optional)

Temperature lowering only becomes active while the vehicle is running and if the heater (independent heater mode) is switched on. The control stages are reached earlier and the heater's control action is adjusted to the lower heat requirement.

The temperature can be lowered by connecting the positive cable (D+) to connector B2, terminal C3 of the heater cable harness (see circuit diagrams, Page 32 and 34).

### Heating mode at high altitudes – up to 3500 m asl

The combustion behaviour of the heater changes with increasing altitude, due to the lower air density. The heater has an automatic altitude detection device which it uses to automatically compensate for the change in air density, i.e. the combustion ratio between fuel and air is adapted to the ambient conditions by reducing the fuel quantity.



### Please note!

- The usual switching limit for altitude detection lies between 1000 m asl and 2000 m asl and solely depends on the local climatic conditions.
- The maximum heating output of the Hydronic M10 / M12 in "Altitude Mode" is 8,5 kW.
- The Hydronic M8 Biodiesel does not have an altitude detection device. Unrestricted heating mode is possible up to 1500 m asl.
- Heaters suitable for high altitudes have "H Kit" marked on the side of the nameplate.

# AUXILIARY HEATER

## Hydronic M-II

### Description of functions

#### Switching on

On being switched on, the switch-on check is displayed in the control unit. The heater starts, whereby the water pump and the combustion air blower start up first.

The glow phase of the glow pencils begins simultaneously with distribution of the combustion air.

The metering pump starts fuel feed somewhat delayed. The glow pencils are switched off if a stable flame has formed in the combustion chamber.

#### Heating mode

After starting, the heater runs with "POWER" stage until the water temperature exceeds the "POWER" / „HIGH" changeover threshold.

#### Hydronic M8 Biodiesel / M10

Then, depending on the heat requirement, the heater switches to the "HIGH – MEDIUM – LOW – OFF" stages.

#### Hydronic M12

Then, depending on the heat requirement, the heater switches to the "HIGH –

MEDIUM 1 / MEDIUM 2 / MEDIUM 3 – LOW – OFF" stages.

If the heating requirement in the "LOW" stage is so small that the cooling water temperature reaches 86 °C, the heater switches from "LOW" to "OFF".

An after-run of approx. 180 seconds follows.

The water pump remains active until the controlled start. If the cooling water has cooled to approx. 72 °C, the Hydronic M8 / M10 heater starts in "MEDIUM" stage, the Hydronic M12 heater starts in "MEDIUM 1" stage.

If the cooling water temperature reaches approx. 55 °C the temperature sensor switches the vehicle fan on.

#### Switching off

After switching off, the heater briefly switches to "LOW" stage to reduce emissions and smoke formation.

This process can take up to 40 seconds maximum if the fuel quantity is constantly reduced.

Once this process has finished the heater starts the after-run for 180 seconds.

During the after-run both glow plugs are switched on alternately.



### Please note!

In independent heater mode (vehicle engine and heater are switched on), always ensure that the heater is completely switched off before entering a petrol station area.

### Control and safety devices

The heater is equipped with the following control and safety devices:

- If the heater does not ignite within 74 seconds after starting the fuel pump, the start is repeated. If the heater still does not ignite after another 65 seconds, the heater is switched off.\*
- After an unacceptable number of failed start attempts, the controller is locked.\*\*
- If the flame goes off by itself during operation, the heater is restarted. If the heater does not ignite within 74 seconds after the fuel pump has started again, the heater is switched off.\*
- After an unacceptable number of failed start attempts, the controller is locked.\*\*
- In the case of overheating (e.g. lack of water, poorly vented coolant circuit), the overheating sensor triggers, the fuel supply is interrupted and the heater switched off.\*

Once the cause of overheating has

# AUXILIARY HEATER

## Hydronic M-II

- been eliminated, the heater can be re-started by switching off and on again (on condition that the heater has cooled down again sufficiently, cooling water temperature <72 °C). After the heater has been switched off for overheating an unacceptable number of times, the controller is locked.\*
- The heater is switched off if the upper or lower voltage limit is reached.\*
- The heater does not start up if the electric cable to the metering pump is interrupted.
- If one of the two glow plugs is defective the start sequence takes place with one glow plug only.
- The speed of the fan motor is monitored continuously. If the blower motor does not start up if it is blocked, or if the speed differs by > 12.5 % from the desired speed a safety lockout (shutdown on faults) takes place after 60 sec.\*
- The water pump's function is continuously monitored.  
\* This status can be remedied by briefly switching off and on again.  
\*\*For details of how to cancel the lock and to read out errors, refer to the Troubleshooting and Repair instructions of the heater.



### Please note!

Do not switch the heater off and on again more than twice.

Forced shut-down for ADR / ADR99 operation

In vehicles for the transport of dangerous goods (e.g. tanker trucks), the heater must be switched off before the truck drives into a danger area (refinery, fuel service station, etc.)

### Failure to comply results in the heater switching off automatically when:

- The vehicle engine is switched off.
- An additional unit is started up (e.g. auxiliary drive for unloading pump etc.).
- A vehicle door is opened (ADR99 regulation, only in France).

The fan then runs on for max. 40 seconds.

### Emergency shutdown – EMERGENCY OFF

If an emergency shutdown – EMERGENCY OFF – is necessary during operation, proceed as follows:

- Switch the heater off with the control or
- pull the fuse out or
- disconnect the heater from the battery.

# AUXILIARY HEATER

## Hydronic M-II

### Heater wiring

The heater is to be connected up electrically according to the EMC directives.



### CAUTION!

#### Safety instructions for wiring the heater

EMC can be affected if the heater is not connected up correctly. For this reason, comply with the following instructions:

- Ensure that the insulation of electrical cables is not damaged. Avoid: chafing, kinking, jamming or exposure to heat.
- In waterproof connectors, seal any connector chambers not in use with filler plugs to ensure they are dirt- and water-proof.
- Electrical connections and ground connections must be free of corrosion and firmly connected.
- Lubricate connections and ground connections outside the heater interior with contact grease.



### Please note!

Comply with the following when wiring the heater and the control element:

- Electrical leads, switchgear and controllers must be arranged in the vehicle so that they can function

perfectly under normal operating conditions (e.g. heat exposure, moisture etc.).

- The following cable cross sections are to be used between the battery and heater. This ensures that the max. tolerable voltage loss in the cables does not exceed 0.5 V for 12 V or 1 V for 24 V rated voltage. Cable cross sections for a cable length of:
  - up to 5 m (plus cable + minus cable) = cable cross section 4 mm<sup>2</sup>
  - from 5 to 8 m (plus cable + minus cable) = cable cross section 6 mm<sup>2</sup>
- If the plus cable is to be connected to the fuse box (e.g. terminal 30), the vehicle cable from the battery to the fuse box must be included in rating the overall cable length and possibly re-dimensioned if necessary.
- Insulate unused cable ends.

#### Notes on rewiring the 12-pin cable harness connector

If, on replacing the Hydronic M (Hydronic 10) with the Hydronic M-II, the cable harness already installed in the vehicle is to be reused it is necessary to remove the 12-pin connector using the AMP release tool and to rewire it according to the following table (AMP Order No. 1-1579007-4).



# AUXILIARY HEATER

## Hydronic M-II

### 12-pin connection pin assignment

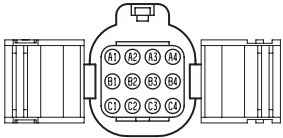

Connector is shown from the cable entry side.

Connection	Cable harness Hydronic M		Rewiring 12-pin connector	
		Cross-section Cable colour	Hydronic M PIN	Hydronic M-II PIN
Dosing pump		1,5 <sup>2</sup> gn	C4 →	A1
Terminal 31		4 <sup>2</sup> br	C3 →	A2*
Terminal 30		4 <sup>2</sup> rt	C2 →	A3*
Plus signal Main battery switch		1,5 <sup>2</sup> ws/rt	C1 →	A4*
Plus signal Solenoid valve relay		-	B4 →	B1
Diagnosis		1 <sup>2</sup> bl	B3 →	B2
Plus signal ADR auxiliary drive		1 <sup>2</sup> vi	B2 →	B3
External control Water pump		-	B1 →	remains unused*
Relay, blower		1 <sup>2</sup> rt/ge	A4 →	C1
D+ for ADR mode		1 <sup>2</sup> vi/gn	A3 →	C2
Temperature drop		-	A2 →	C3
Heater ON		1 <sup>2</sup> ge	A1 →	C4

\*External control of the water pump is not planned for Hydronic M-II.

# AUXILIARY HEATER

## Hydronic M-II

### Parts list for the circuit diagrams Hydronic M-II – 12 Volt / 24 Volt

- 1.1 Burnerengine
- 1.2 Glow plug 1
- 1.2.1 Glow plug 2 (optional 12kW / FAME)
- 1.5 Overheating sensor
- 1.12 Flamesensor
- 1.13 Temperature sensor
- 2.1 Controller
- 2.2 Dosing pump
- 2.5.7 Relay, vehicle fan
- 2.5.18 Relay, water circuit change-over – to be fitted by the customer as required.
- 2.7 Main fuse 12 volt = 20 A  
24 volt = 15 A
- 2.7.1 Fuse, actuation 5A
- 2.7.5 Fuse, vehicle fan 25 A
- 2.12 Water pump
- 5.1 Battery
- 5.10 Vehicle fan

a) Connection for control unit

12-pin connection pin assignment  
(external)

PIN-No.	Connection	Cable cross-section mm <sup>2</sup>
A1	Dosing pump	1.5
B1	Solenoid valve, optional	1.0
C1	Relay, blower	1.0
A2	Terminal 31	4.0
B2	Diagnosis cable (OEM)	-
C2	unused	-
A3	Terminal 30	4.0
B3	unused	-
C3	Temperature drop	1.0
A4	Plus signal output.	1.5
B4	Diagnosis (HELJED)	1.0
C4	Heater ON	1.0

b) Water circuit change-over: Relay makes contact at 68 °C and breaks contact at 63 °C water temperature (with temperature drop 58 °C / 45 °C)

c) Heater connection

d) Temperature drop (with positive signal)

e) Connect the cables in the control's connector

x) Disconnect cable

a2) Diagnosis

a3) Switch-on signal S+

a4) Power supply plus, +30

a5) Power supply minus, -31

a6) (+) Release the battery disconnecting switch (diode: order no. 208 00 012)  
Connectors and bush housings are shown from the cable inlet side.

# AUXILIARY HEATER

## Hydronic M-II



### Please note!

To connect the control units

- for EasyStart R+ / R / T: use the 0.752 bl/ws cable, heater connector B2, chamber B4,
- for all other control units: use the 0.752 ge cable, heater connector B2, chamber C4, • See page 32 for circuit diagram.

### Cable colours

rt = red

bl = blue

ws = white

sw = black

gn = green

gr = grey

ge = yellow

vi = violet

# AUXILIARY HEATER

## Hydronic M-II

Circuit diagram Hydronic M-II – 12 Volt / 24 Volt

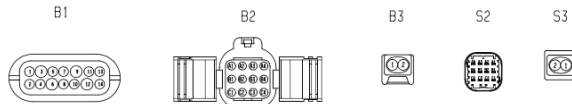
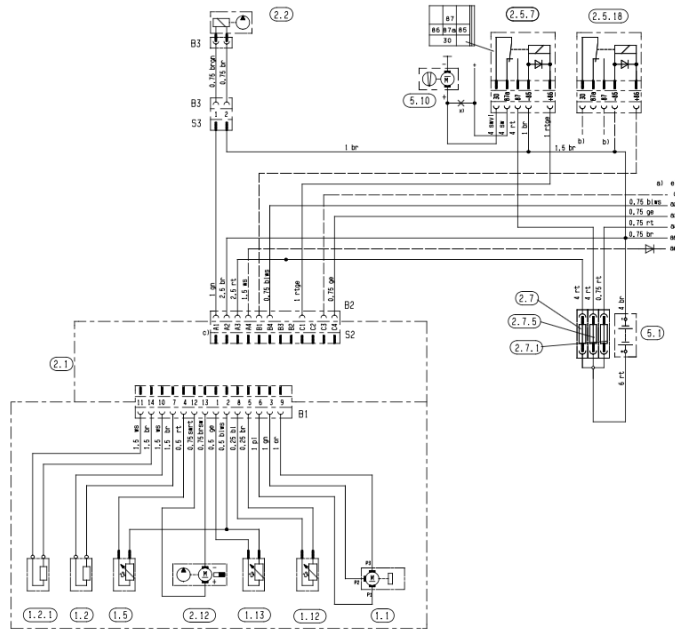

25 2435 00 96 01

# AUXILIARY HEATER

## Hydronic M-II

### Parts list for the circuit diagrams Hydronic M-II, 12 Volt / 24 Volt, ADR

- 1.1 Burnerengine
- 1.2 Glow plug 1
- 1.2.1 Glow plug 2
- 1.5 Overheating switch
- 1.12 Flamesensor
- 1.13 Temperature sensor
- 2.1 Controller
- 2.2 Fuel dosing pump
- 2.5.7 Relay, vehicle fan
- 2.5.18 Relay, changeover water circuit  
To be fitted by customer if required
- 2.7 Main fuse  
12 volt = 20 A  
24 volt = 15 A
- 2.7.1 Fuse, actuation 5A
- 2.7.5 Fuse, vehicle fan 25 A
- 2.12 Waterpump
- 5.1 Battery
- 5.10 Vehicle fan
- 5.2.1 Battery main switch (operation e.g. separate from ignition lock), g)
- 5.2.2 Battery disconnection switch (EMERGENCY OFF function for ADR), g)
- 5.10 Vehiclefan

#### a) Connection for control unit

#### 12-pin connection pin assignment (external)

PIN-No.	Connection	Cable cross-section mm <sup>2</sup>
A1	Dosing pump	1.5
B1	Solenoid valve, optional	1.0
C1	Relay, blower	1.0
A2	Terminal 31	4.0
B2	Diagnosis cable (OEM)	-
C2	D+	1.0
A3	Terminal 30	4.0
B3	TRS signal (ADR)	1.0
C3	Temperature drop	1.0
A4	Plus signal output	1.5
B4	Diagnosis (HELJED)	1.0
C4	Heater ON	1.0

- b) For ADR D+ (dynamo)
- c) For ADR HA+ (auxiliary drive/ secondary drive) minus circuit, if not present, route lead to +
- d) Changeover water circuit: relay closes at 68 °C and opens at 63 °C water temperature (with temperature decrease 58 °C / 45 °C)
- e) Connectionheater
- f) Temperature drop (with plus signal)
- g) If only one switching element is used for items 5.2.1 and 5.2.2, it is necessary to ensure that on pressing the battery disconnecting switch (EMERGENCY OFF function in ADR), the switch always breaks contact immediately (regardless of the heater condition) and all the heater's circuits are disconnected from the battery.
- h) Connect the cables in the control's connector x) Disconnect lead
  - a1) ADR feedback
  - a2) Dagnosis
  - a3) Switch-on signal S+
  - a4) Power supply plus +30
  - a5) Power supply minus -31
  - a6) (+) Trigger battery disconnecting switch (diode: order no. 208 00 012)

# AUXILIARY HEATER

## Hydronic M-II

Connectors and bush housings are shown from the cable inlet side.



### Please note!

To connect the control units

- for EasyStart R+ / R / T: use the 0.752 bl/ws cable, heater connector B2, chamber B4,
- for all other control units: use the 0.752 ge cable, heater connector B2, chamber C4,
- See page 34 for circuit diagram.

### Cable colours

rt = red

bl = blue

ws = white

sw = black

gn = green

gr = grey

ge = yellow

vi = violet

# AUXILIARY HEATER

## Hydronic M-II

Circuit diagram Hydronic M-II 12 Volt / 24 Volt ADP

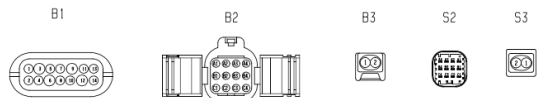
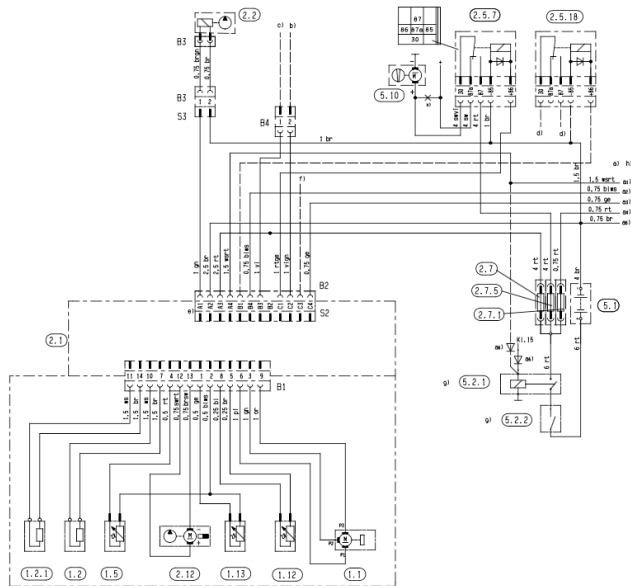

25 2435 00 96 02

# AUXILIARY HEATER

## Hydronic M-II

### Parts list for the circuit diagrams for the control elements EasyStart R+ / EasyStart R / EasyStart T and EasyStart T – ADR

- 2.15.1 Temperature sensor (room temperature) (included in the EasyStart R+ scope of supply, optional for EasyStart T)
- 2.15.9 External temperature sensor
- 3.1.7 "ON / OFF" button
- 3.1.16 Radio remote control button
- 3.2.15 EasyStart T timer
- 3.3.9 EasyStart R radio remote control (stationary unit)
- 3.3.10 EasyStart R+ radio remote control (stationary unit)
- 3.6.1 Adaptercable
- 3.8.3 Antenna

- c) Terminal 58 (lighting)
- e) EasyStart T timer connection
- g) External "ON / OFF" button (optional)
- x) ADRjumper



### Please note!

- The timer / radio remote control must be connected in accordance with the circuit diagrams (page 36 – 39).
- Insulate unused cable ends.
- Connectors and bush housings are shown from the cable inlet side.

### Cable colours

- rt = red
- bl = blue
- ws = white
- sw = black
- gn = green
- gr = grey
- ge = yellow
- vi = violet



# AUXILIARY HEATER

## Hydronic M-II

Circuit diagram for the control element EasyStart R+

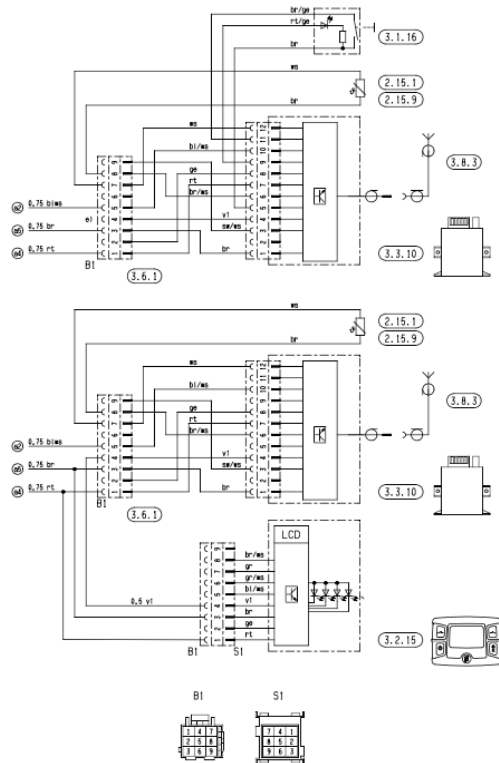

25 2435 00 97 01 A

# AUXILIARY HEATER

## Hydronic M-II

Circuit diagram for the control element EasyStart R

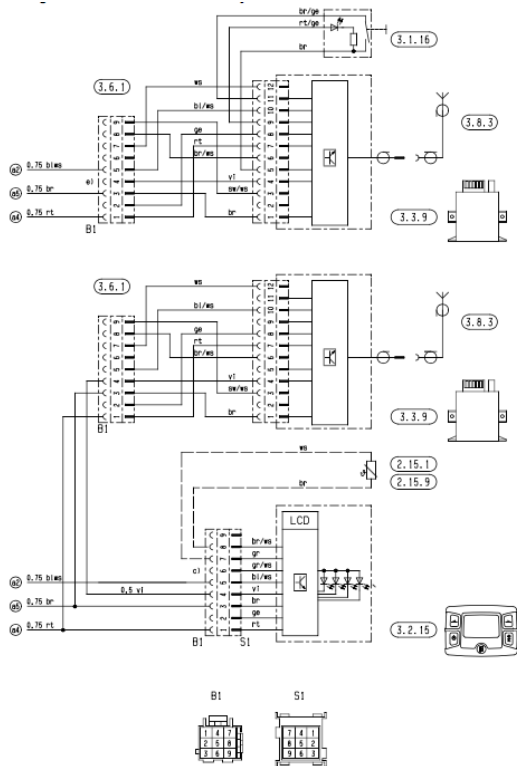

25 2435 00 97 02 A

# AUXILIARY HEATER

Hydronic M-II

Circuit diagram for the control element EasyStart T

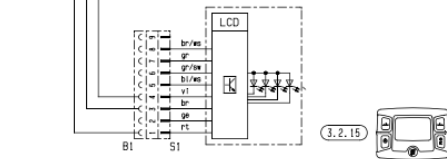
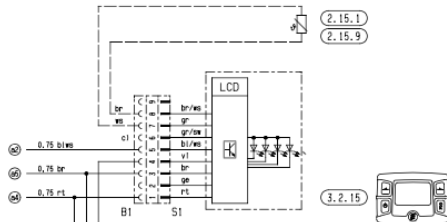
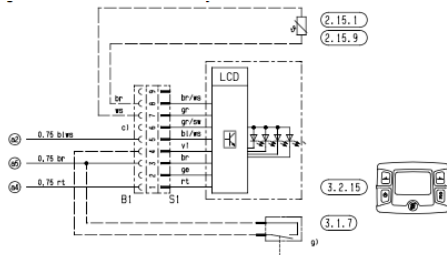

25 2435 00 97 02 A

# AUXILIARY HEATER

## Hydronic M-II

Circuit diagram for the control element EasyStart T – ADR

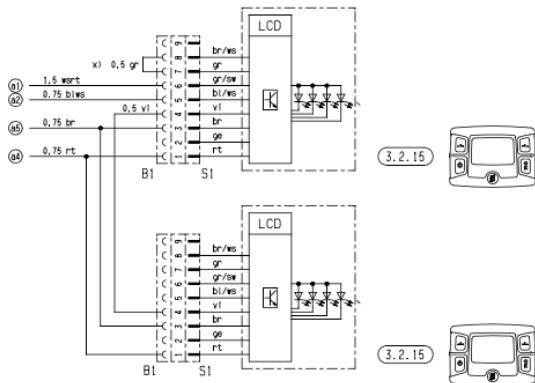
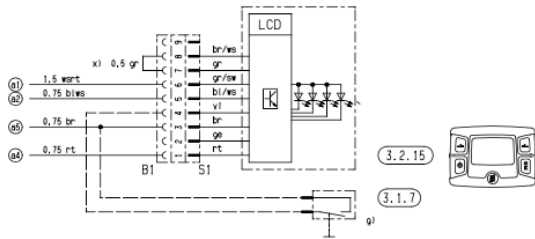

25 2435 00 97 04 A

# AUXILIARY HEATER

## Hydronic M-II

### In case of faults, please check the following points

- If the heater does not start after being switched on: – Switch the heater off and on again.
- If the heater still does not start, check whether:
  - There is fuel in the tank?
  - The fuses are OK?
  - The electrical cables, connections etc. are OK?
  - Anything is clogging the combustion air supply or exhaust system?
- Check the openings of the combustion air supply and exhaust system after longer standstill periods, clean if necessary!

### Troubleshooting

If the heater remains faulty even after these points have been checked, or another malfunction occurs in your heater, please contact:

- For installation ex works, your contract workshop.
- For subsequent installation, the workshop who installed your heater.
- 



### Please note!

Please note that warranty claims can be become void if the heater is changed by a third party or by this installation of third party parts.

### Maintenance instructions

- Switch the heater on once a month for about 10 minutes, even outside the heating period.
- Before the heating period starts, the heater should undergo a trial run. If persistent extreme smoke developments, unusual burning noises or a clear fuel smell can be perceived or if electric / electronic parts heat up, the heater must be switched off and put out of service by removing the fuse.  
In this case, the heater should not be started up again until it has been checked by qualified staff who have been trained on Eberspächer heaters.

### Service

If you have any technical queries or problems with your pre-heater, dial the following service phone number:

Hotline

Phone 00 49 (0)800 / 12 34 300

Fax hotline

Fax 00 49 (0)1805 / 26 26 24

Outside of Germany, please contact the respective national Eberspächer service agent.

# AUXILIARY HEATER

## Hydronic M-II

### Certification

The high quality of Eberspächer's products is the key to our success.

To guarantee this quality, we have organised all work processes in the company along the lines of quality management (QM).

Even so, we still pursue a large number of activities for continuous improvement of product quality in order to keep pace with the similarly constantly growing requirements made by our customers.

All the steps necessary for quality assurance are stipulated in international standards.

This quality is to be considered in a total sense.

It affects products, procedures and customer/supplier relationships.

Officially approved public experts assess the system and the corresponding certification company awards a certificate. Eberspächer has already qualified for the following standards:

**Quality management as per  
DIN EN ISO 9001:2000 and ISO/TS  
16949:1999**

### Environment management system as per DIN EN ISO 14001:1996

#### Disposal

##### Disposal of materials

Old devices, defect components and packaging material can all be separated and sorted into pure-grade fractions so that all parts can be disposed of as required in an environment-friendly manner or recycled where applicable. Electric motors, controllers and sensors (e.g. temperature sensors) are deemed to be "electronic scrap".

##### Dismantling the heater

The heater is dismantled according to the repair stages in the current troubleshooting / repair instructions.

#### Packaging

The packaging of the heater can be kept in case it has to be sent back.

### EU Declaration of Conformity

With regard to the following products

### Heater type Hydronic M-II

we herewith confirm that it conforms with the prime safety requirements stipulated in the directives of the EU Council for harmonisation of the legal regulations of the member states with regard to electromagnetic compatibility (89 / 336 / EEC).

This declaration applies to all heaters produced according to the production drawings Hydronic M-II which are an integral part of this declaration.

The following standards / directives have been used to assess the product with regard to electromagnetic compatibility:

- EN 50081 – 1 Basic form interference emission.
- EN 50082 – 1 Basic form interference resistance.
- 72 / 245 / EEC – Modification status 2006 / 28 / EG interference suppression in motor vehicles.

### Declaration of Conformity

Your vehicle may have components that transmit and receive radio waves and are therefore subject to government regulations.

These components must accept all interference received, including that which may cause undesired operation.

Visit

<https://www.fordtrucks.com.tr/en/conformity>

for certification labels and declaration of conformity.

## **MANUFACTURER FIRM**

Ford Otomotiv Sanayi A.S.  
Akpınar Mah. Hasan Basri Cad. No: 2  
34885 Sancaktepe/Istanbul